



*Be Light*

Newline  
iluminação

W H I T E





[www.newline.ind.br](http://www.newline.ind.br)



+55 11 4751-6350



[vendas@newline.ind.br](mailto:vendas@newline.ind.br)



[facebook.com/newlineiluminacao](https://facebook.com/newlineiluminacao)



[@newlineiluminacao](https://instagram.com/newlineiluminacao)



*Be Light!*

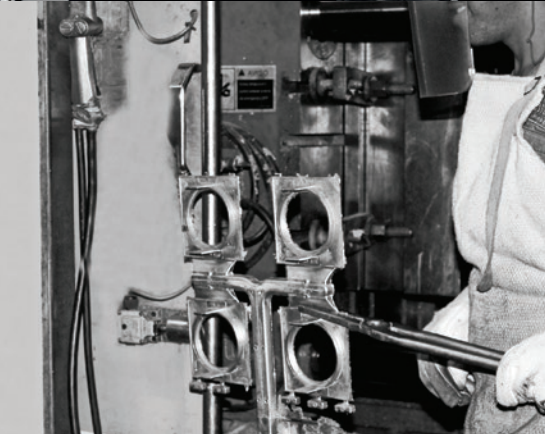

**Newline** 22  
iluminação **anos**

### Uma empresa 100% nacional

Desde 1999 a Newline acredita e investe no mercado brasileiro através do desenvolvimento de novas tecnologias, produtos com design 100% nacional e da busca constante por melhorias de infraestrutura: são mais de 11.000 m<sup>2</sup> de modernas instalações e uma equipe de colaboradores preparados para atender com excelência aos diversos segmentos do mercado de iluminação.

Oferecemos, de forma sustentável, soluções que agregam qualidade, tecnologia, design, inovação e eficiência, proporcionando maior bem estar e qualidade de vida aos nossos clientes. Como marca de referência em nosso segmento, buscamos o aprimoramento constante e a aplicação da tecnologia em todos os nossos processos e produtos, sempre baseados em nossos valores e objetivos: ser uma empresa inovadora e de vanguarda, que atua de maneira ética com todas as pessoas envolvidas em seus processos: colaboradores, clientes, fornecedores e parceiros comerciais.

### Planta fabril com modernas, seguras e eficientes instalações:

- Injeção de alumínio
- Torno CNC
- Corte CNC de perfis de alumínio
- Pintura Eletrostática
- Pintura Líquida
- Montagem Led



Como Empresa Amiga do Bem ajudamos a levar alimentos, saúde, educação e esperança para mais de 60 mil pessoas nos estados de Alagoas, Ceará e Pernambuco.

Nosso sucesso é construído por

# pessoas

• Mais de 300 empregos diretos gerados na região da Grande SP.

• Mais de 65% do quadro de colaboradores Newline composto por mulheres.

• Treinamentos e aprimoramentos constantes da equipe de colaboradores.

• Geração de novas oportunidades: Alto índice de contratações através do programa Jovem Aprendiz e projetos de promoções internas.

Conheça um pouco mais das nossas histórias. acesse:



# ÍNDICE

## INFORMAÇÕES GERAIS

Quantidade de produtos: 586 SKUs. Para consulta por códigos, verifique o sumário ordenado por referência na página 137.

Imagens ilustrativas. Para melhor referência, solicite o mostruário de acabamentos ao seu representante.

## GLOSSÁRIO TÉCNICO

### Fluxo da fonte (lm):

Fluxo luminoso da fonte de luz

### Fluxo da luminária (lm):

Fluxo luminoso após o difusor

Todos os ensaios técnicos foram realizados com as peças no acabamento branco. Produtos com acabamentos em outras cores, como preto por exemplo, podem sofrer alterações nos resultados, como diminuição do fluxo luminoso.

### Curva fotométrica

Linha Vermelha = Plano longitudinal  
Linha Azul = Plano transversal

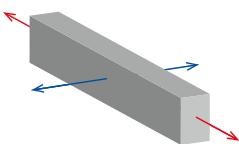

### Glossário de acabamentos apresentados

- ◆ **AM** | Amarelo Brilho
- ◆ **BR** | Branco
- ◆ **BT** | Branco Total
- ◆ **CE** | Cobre Escovado
- ◆ **CO** | Cobre
- ◆ **DO** | Dourado
- ◆ **FD** | Fendi
- ◆ **FF** | Fendi Fosco (Concreto)
- ◆ **MC** | Marrom Corten
- ◆ **ND** | Nude
- ◆ **NF** | Nude Fosco
- ◆ **PB** | Preto Brilho
- ◆ **PT** | Preto Total
- ◆ **VM** | Vermelho Brilho



Fit Edge pg. 10



Fit Edge pg. 11



Fit Edge pg. 12

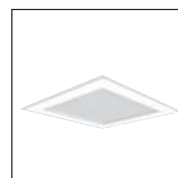

Fit Edge pg. 14



Fit 25 pg. 16

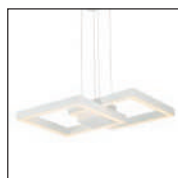

Fit 25 pg. 18

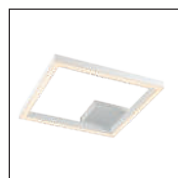

Fit 25 pg. 19

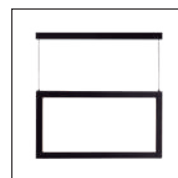

Fit 25 pg. 20



Fit 25 pg. 21



Fit 25 pg. 22



Fit 25 pg. 23



Fit 25 pg. 24

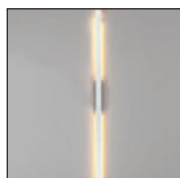

Fit 25 pg. 25



Fit 25 pg. 26



Fit 25 pg. 27

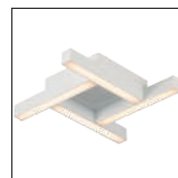

Fit 25 pg. 28

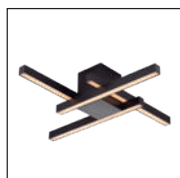

Fit 25 pg. 29



Fit 25 pg. 30



Fit 25 pg. 31



Spin pg. 34



Spin pg. 36



Shape pg. 38



Apollo pg. 40

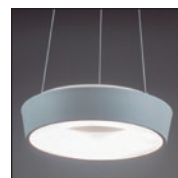

Apollo pg. 42



COMPONENTES  
SUBSTITUÍVEIS COM  
GARANTIA DE REPOSIÇÃO

# Be Light!

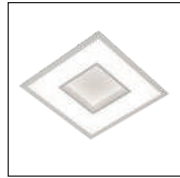

New Chess pg. 44



New Chess pg. 45

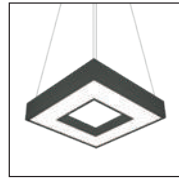

New Chess pg. 46



Sobrepur II pg. 47



Wide pg. 48



Wide pg. 49

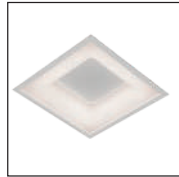

New Massu pg. 50

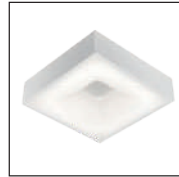

New Massu pg. 51



New Massu pg. 52



Tray Led pg. 53



Victoria pg. 54



Victoria pg. 55



Circle pg. 56



Circle pg. 57



Sushi pg. 58



Sushi pg. 59



Ring pg. 60



Ring pg. 61



Chess pg. 62



Chess pg. 63



New Quadrus pg. 64



Wood pg. 65



Bilboquê pg. 66



Bambola pg. 68



New Industrial pg. 70



New Round pg. 72



Naval pg. 73



Lisse pg. 74



Lisse I / II pg. 76



Lisse I pg. 77

# ÍNDICE

## INFORMAÇÕES GERAIS

Quantidade de produtos: 586 SKUs. Para consulta por códigos, verifique o sumário ordenado por referência na página 137.

Imagens ilustrativas. Para melhor referência, solicite o mostruário de acabamentos ao seu representante.

## GLOSSÁRIO TÉCNICO

### Fluxo da fonte (lm):

Fluxo luminoso da fonte de luz

### Fluxo da luminária (lm):

Fluxo luminoso após o difusor

Todos os ensaios técnicos foram realizados com as peças no acabamento branco. Produtos com acabamentos em outras cores, como preto por exemplo, podem sofrer alterações nos resultados, como diminuição do fluxo luminoso.

### Curva fotométrica

Linha Vermelha = Plano longitudinal  
Linha Azul = Plano transversal

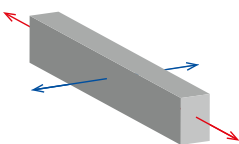

## Glossário de acabamentos apresentados

- ◆ **AM** | Amarelo Brilho
- ◆ **BR** | Branco
- ◆ **BT** | Branco Total
- ◆ **CE** | Cobre Escovado
- ◆ **CO** | Cobre
- ◆ **DO** | Dourado
- ◆ **FD** | Fendi
- ◆ **FF** | Fendi Fosco (Concreto)
- ◆ **MC** | Marrom Corten
- ◆ **ND** | Nude
- ◆ **NF** | Nude Fosco
- ◆ **PB** | Preto Brilho
- ◆ **PT** | Preto Total
- ◆ **VM** | Vermelho Brilho

Pleine Lune pg. 78	Iris pg. 80	Iris pg. 81	New Picture pg. 82
New Picture pg. 83	Track pg. 84	Track pg. 85	Box pg. 86
Cube pg. 88	Box Foco pg. 90	Lisse I pg. 92	Lisse II pg. 93
Fit 25 pg. 94	Track pg. 95	Track pg. 96	Track pg. 97
Sobrepor III pg. 98	Sobrepor III pg. 99	Sobrepor III pg. 100	Sobrepor III pg. 101
Slim II pg. 102	Slim II pg. 103	Slim II pg. 104	Slim II pg. 105



COMPONENTES  
SUBSTITUÍVEIS COM  
GARANTIA DE REPOSIÇÃO



# Be Light!



Flat Led pg. **106**



Flat pg. **107**

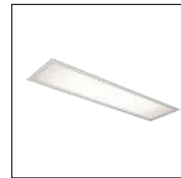

Flat pg. **108**



Flat pg. **109**



No Frame II Led pg. **110**



No frame pg. **111**



No frame pg. **112**



No frame pg. **113**



No frame pg. **114**



Inside Redonda pg. **115**



Flat pg. **116**

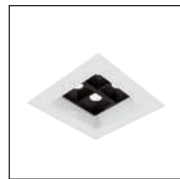

Flat Foco pg. **117**



Lisse II pg. **118**



Recuado II pg. **119**



No Frame II pg. **120**



No Frame Foco pg. **121**



No Frame Redondo pg. **122**



Lisse II Pin Hole pg. **123**



Trilhos pg. **124**



Lisse Solution pg. **125**



Lisse Solution II pg. **126**



Lisse Solution II pg. **128**



Lisse Solution II pg. **129**



Portara pg. **130**



Portara pg. **131**



Lisse pg. **132**



Lens pg. **133**



New Trace/  
New Clean  
Quadrada pg. **134**



Lisse Led pg. **136**

## FIT EDGE COM FOCO | embutido

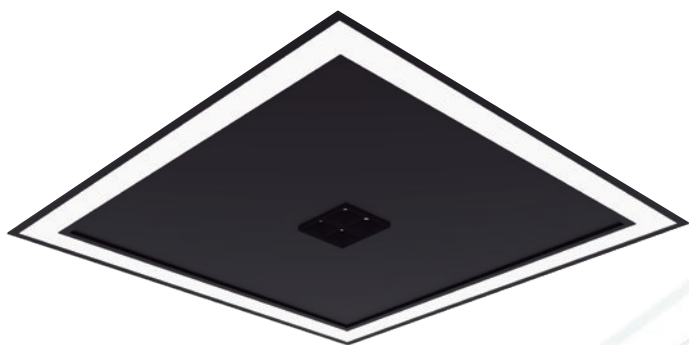

LedLINE

**3 ANOS DE GARANTIA**  
CONTRA DEFECTOS DE FABRICAÇÃO

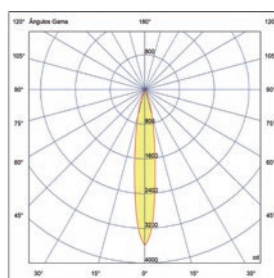
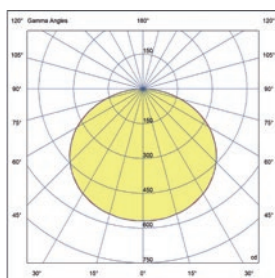
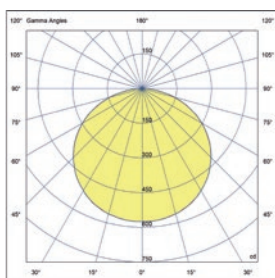

Curva IES / Focos

- Possibilita diferentes efeitos luminotécnicos, podendo ser utilizado como luz geral e ou de destaque
  - Acendimento individual da luz difusa e luz pontual\*
  - Disponível nas opções de 3000k e 4000k
  - Molas em aço inox
  - Foco central com lente antiofuscante
  - Fácil instalação
- \* Para acionamento isolado (luz foco ou difusa) é necessária a instalação individual no interruptor elétrico.

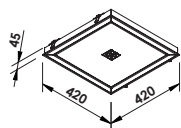

EM0127LED

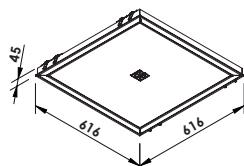

EM0128LED

### MATERIAL

Produzido em alumínio  
Difusor de acrílico  
Consulte todos os acabamentos disponíveis

PRODUTO BIVOLT (127V/220V)

EMBUITO COM FOCO									
CÓDIGO	POTÊNCIA	FLUXO FONTE LUMINOSA DIFUSA (lm)	FLUXO LUMINÁRIA DIFUSA (lm)	FLUXO FONTE LUMINOSA FOCO (lm)	FLUXO LUMINÁRIA FOCO (lm)	TEMP. COR (K)	FOCO	DIM. (mm)	NICHO (mm)
EM0127LED3	37,6W	4464	1842	600	433	3000 ☉	10°	420 x 420 x 45	410 x 410
EM0127LED4	37,6W	4464	1942	600	456	4000 ○	10°	420 x 420 x 45	410 x 410
MODELOS COMPATÍVEIS COM FORROS MODULARES									
EM0128LED3	36W	4400	1970	600	433	3000 ☉	10°	616 x 616 x 45	606 x 606
EM0128LED4	36W	4400	2074	600	456	4000 ○	10°	616 x 616 x 45	606 x 606



# FIT EDGE COM FOCO | plafon

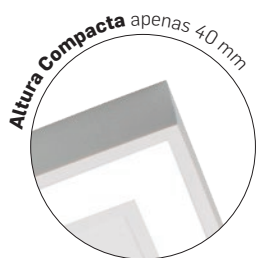

- Possibilita diferentes efeitos luminotécnicos, podendo ser utilizado como luz geral e ou de destaque
- Acendimento individual da luz difusa e luz pontual\*
- Disponível nas opções de 3000k e 4000k
- Foco central com lente antiofuscante
- Fácil instalação

\* Para acionamento isolado (luz foco ou difusa) é necessária a instalação individual no interruptor elétrico.

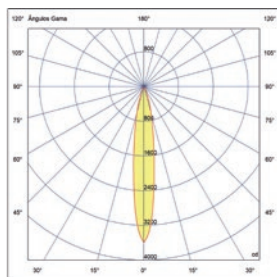

Curva IES / 4 focos

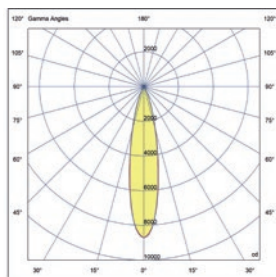

Curva IES / 16 focos



## MATERIAL

Produzido em alumínio  
Difusor de acrílico  
Consulte todos os acabamentos disponíveis

## PRODUTO BIVOLT (127V/220V)

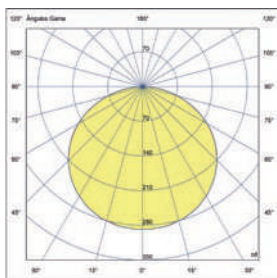

PL0126LED

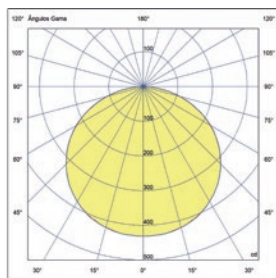

PL0127LED

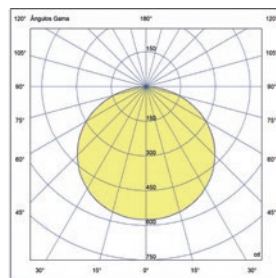
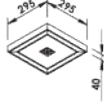

PL0128LED

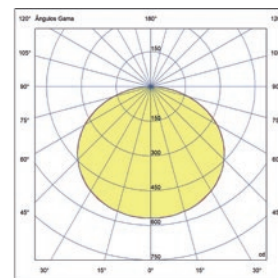
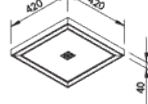

PL0129LED

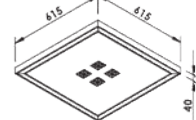

PLAFON COM FOCO								
CÓDIGO	POTÊNCIA	FLUXO FONTE LUMINOSA DIFUSA (lm)	FLUXO LUMINÁRIA DIFUSA (lm)	FLUXO FONTE LUMINOSA FOCO (lm)	FLUXO LUMINÁRIA FOCO (lm)	TEMP. COR (K)	FOCO	DIM. (mm)
PL0126LED3	20,8W	2232	923	600	433	3000	10°	230 x 230 x 40
PL0126LED4	20,8W	2232	971	600	456	4000	10°	230 x 230 x 40
PL0127LED3	29,2W	3348	1384	600	433	3000	10°	295 x 295 x 40
PL0127LED4	29,2W	3348	1457	600	456	4000	10°	295 x 295 x 40
PL0128LED3	37,6W	4464	1842	600	433	3000	10°	420 x 420 x 40
PL0128LED4	37,6W	4464	1942	600	456	4000	10°	420 x 420 x 40
PL0129LED3	48W	4400	1970	2400	1732	3000	10°	615 x 616 x 40
PL0129LED4	48W	4400	2074	2400	1824	4000	10°	616 x 616 x 40



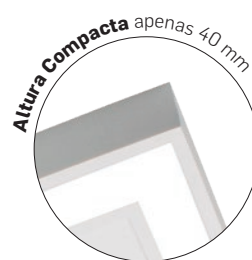

PL0121LED3BT



PL0122LED3PT



PL0123LED3BT



PL0124LED3PT

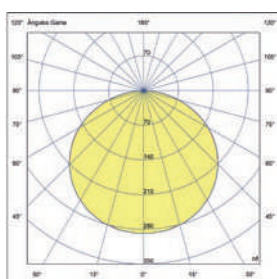

PL0121LED

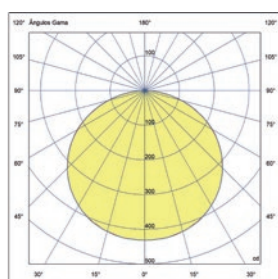

PL0122LED

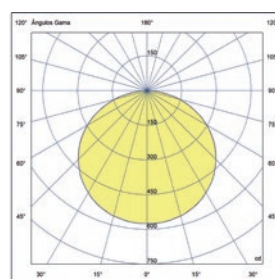
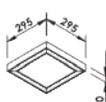

PL0123LED

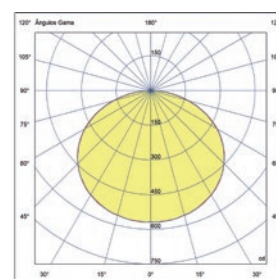
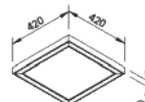

PL0124LED

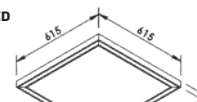

PLAFON					
CÓDIGO	POTÊNCIA	FLUXO DA FONTE (lm)	FLUXO DA LUMINÁRIA (lm)	TEMP. COR (K)	DIM. (mm)
PL0121LED3	16,8W	2232	923	3000 ☉	230 x 230 x 40
PL0121LED4	16,8W	2232	971	4000 ○	230 x 230 x 40
PL0122LED3	25,2W	3348	1384	3000 ☉	295 x 295 x 40
PL0122LED4	25,2W	3348	1457	4000 ○	295 x 295 x 40
PL0123LED3	33,6W	4464	1842	3000 ☉	420 x 420 x 40
PL0123LED4	33,6W	4464	1942	4000 ○	420 x 420 x 40
PL0124LED3	32W	4400	1970	3000 ☉	616 x 616 x 40
PL0124LED4	32W	4400	2074	4000 ○	616 x 616 x 40

### MATERIAL

Produzido em alumínio  
Difusor de acrílico  
Consulte todos os acabamentos disponíveis

PRODUTO BIVOLT (127V/220V)



**3 ANOS DE GARANTIA**  
CONTRA DEFETOS DE FABRICAÇÃO





## FIT EDGE | embutido



EM0121LED3BT



EM0123LED3PT



EM0124LED3BT

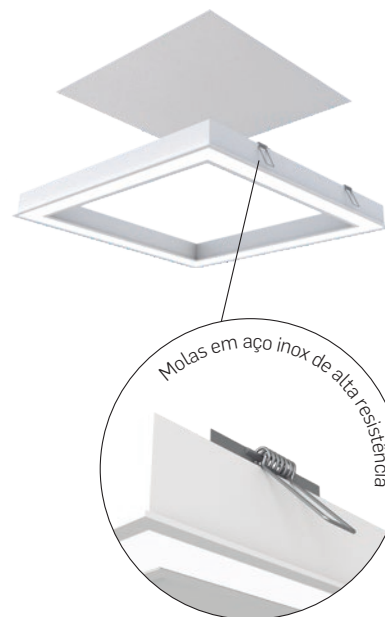

EMBUTIDO						
CÓDIGO	POTÊNCIA	FLUXO DA FONTE (lm)	FLUXO DA LUMINÁRIA (lm)	TEMP. COR (K)	DIM. (mm)	NICHO (mm)
EM0121LED3	16,8W	2232	923	3000 ●	230 x 230 x 45	220 x 220
EM0121LED4	16,8W	2232	971	4000 ○	230 x 230 x 45	220 x 220
EM0122LED3	25,2W	3348	1384	3000 ●	295 x 295 x 45	285 x 285
EM0122LED4	25,2W	3348	1457	4000 ○	295 x 295 x 45	285 x 285
EM0123LED3	33,6W	4464	1842	3000 ●	420 x 420 x 45	410 x 410
EM0123LED4	33,6W	4464	1942	4000 ○	420 x 420 x 45	410 x 410

MODELOS COMPATÍVEIS COM FORROS MODULARES						
EM0124LED3	32W	4400	1970	3000 ●	616 x 616 x 45	606 x 606
EM0124LED4	32W	4400	2074	4000 ○	616 x 616 x 45	606 x 606

- Tecnologia LED e design slim
- Disponíveis nas versões 3000k e 4000k
- Altura compacta: apenas 4,5cm
- Opção do acabamento central em alumínio (placa que acompanha o produto) ou fechamento com o próprio material do forro modular (realizado durante a instalação)
- Modelos compatíveis com forros modulares de 60x60cm



EM0125LED3BT

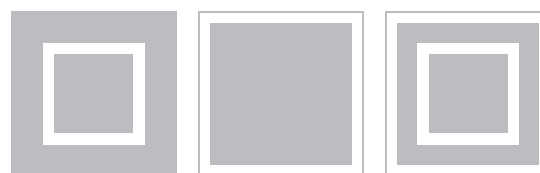

Opção de acendimento individual  
Necessária a instalação individual no interruptor elétrico.

LedLINE

**3 ANOS DE GARANTIA**  
CONTRA DEFETOS DE FABRICAÇÃO

EMBUTIDO DUPLO						
CÓDIGO	POTÊNCIA	FLUXO DA FONTE (lm)	FLUXO DA LUMINÁRIA (lm)	TEMP. COR (K)	DIM. (mm)	NICHO (mm)
EM0125LED3	65,6W	8864	3879	3000 ●	616 x 616 x 40	606 x 606
EM0125LED4	65,6W	8864	4083	4000 ○	616 x 616 x 40	606 x 606

### MATERIAL

Produzido em alumínio  
Difusor de acrílico  
Consulte todos os acabamentos disponíveis

**PRODUTO BIVOLT (127V/220V)**



# FIT EDGE | embutido

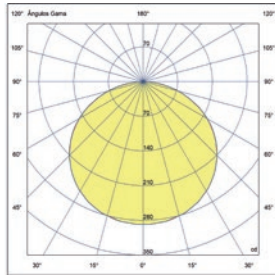

EM0121LED

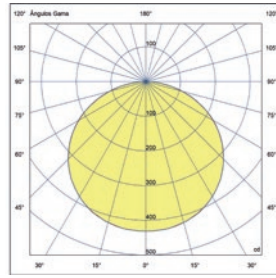

EM0122LED

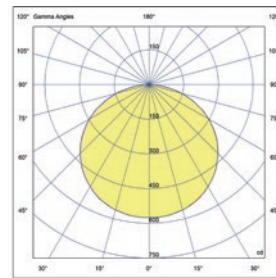

EM0123LED

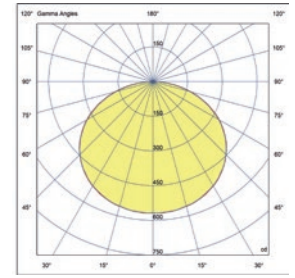
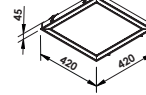

EM0124LED

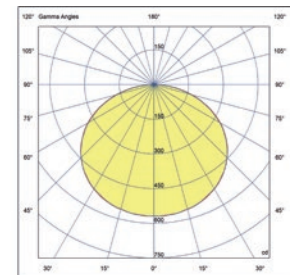

Acendimento externo

EM0125LED

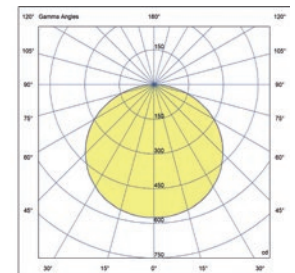

Acendimento interno

EM0125LED

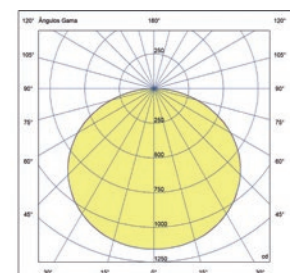

Acendimento interno e externo

EM0125LED

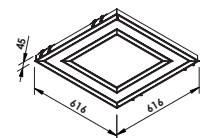

## FIT 25 | plafon/arandela

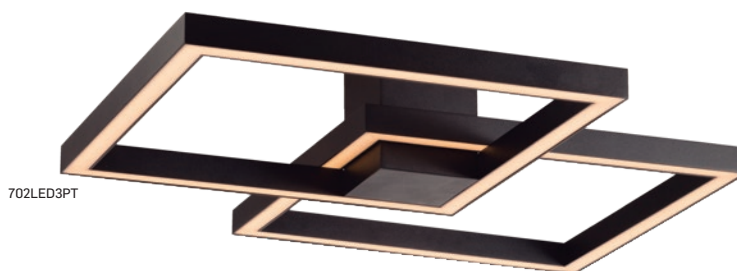

702LED3PT

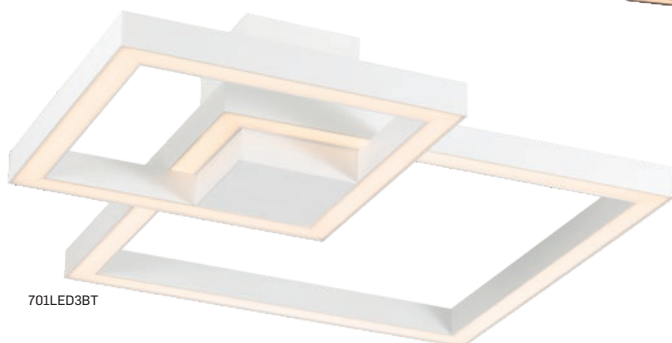

701LED3BT

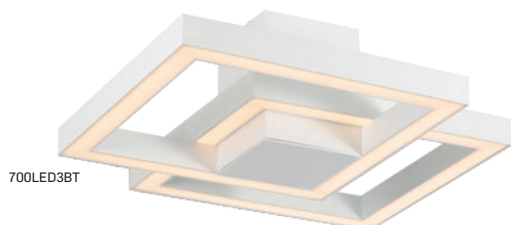

700LED3BT

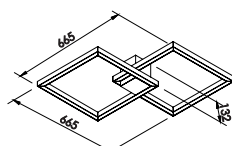
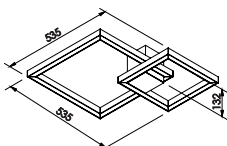
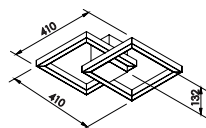
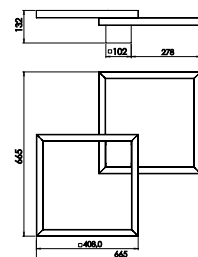
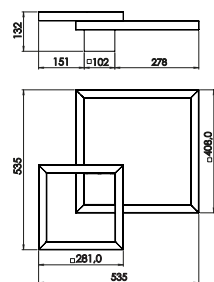
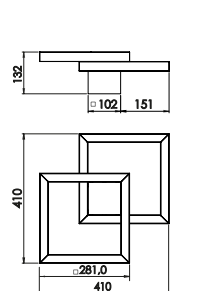
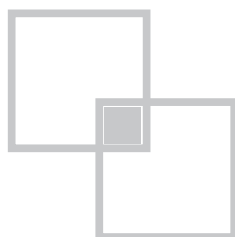
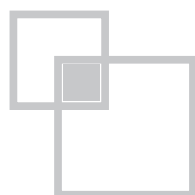

700LED

701LED

702LED

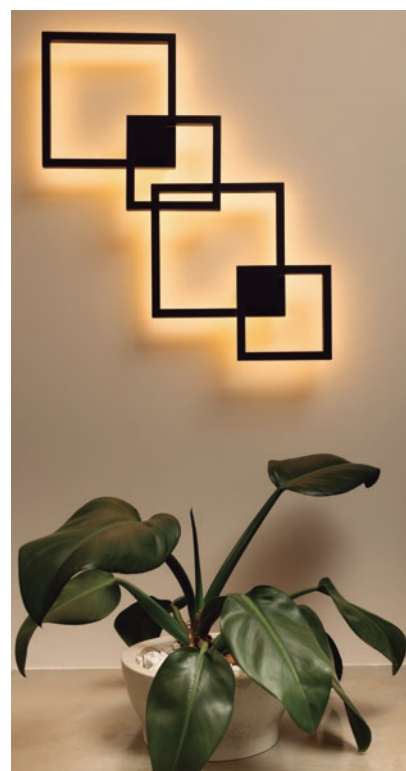

LedLINE

**3 ANOS DE GARANTIA**  
CONTRA DEFECTOS DE FABRICAÇÃO

PLAFON/ARANDELA					
CÓDIGO	POTÊNCIA	FLUXO DA FONTE (lm)	FLUXO DA LUMINÁRIA (lm)	TEMP. COR (K)	DIM. (mm)
700LED3	50,4W	5544	2661	3000 ●	410 x 410 x 132
700LED4	50,4W	5544	2661	4000 ○	410 x 410 x 132
701LED3	58,8W	6488	3105	3000 ●	535 x 535 x 132
701LED4	58,8W	6488	3105	4000 ○	535 x 535 x 132
702LED3	67,2W	7392	3548	3000 ●	665 x 665 x 132
702LED4	67,2W	7392	3548	4000 ○	665 x 665 x 132

### MATERIAL

Produzido em alumínio  
Difusor de acrílico  
Consulte todos os acabamentos disponíveis

**PRODUTO BIVOLT (127V/220V)**





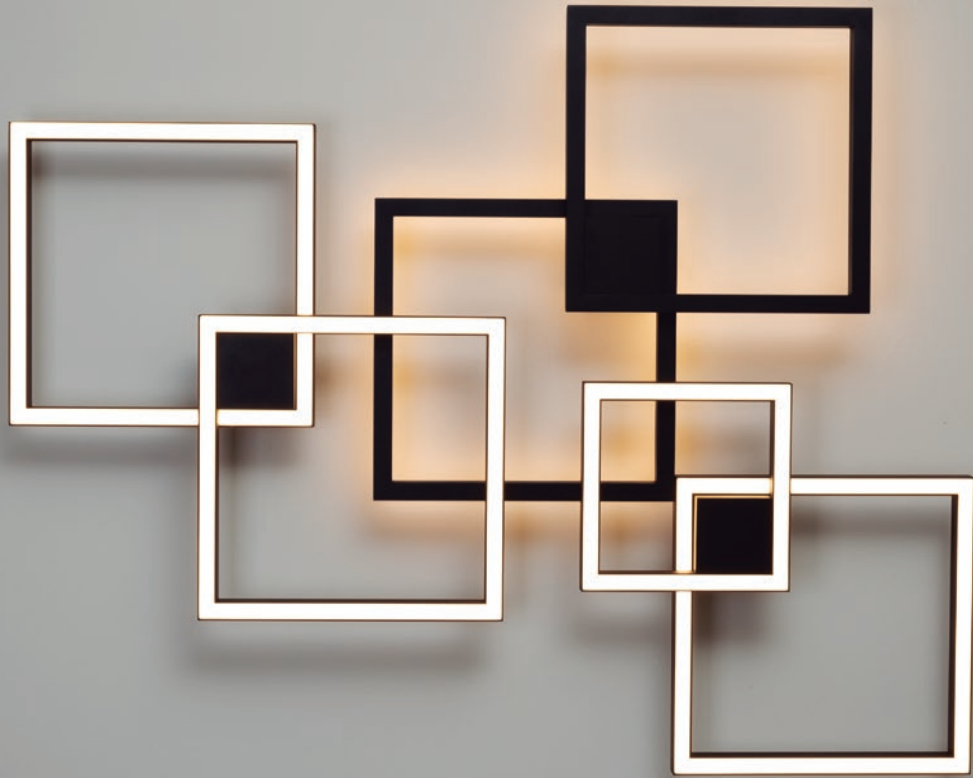

O mesmo produto,  
duas possibilidades  
de montagem

**LUZ DIRETA**  
ou **INDIRETA**

EXEMPLOS DE COMPOSIÇÃO:

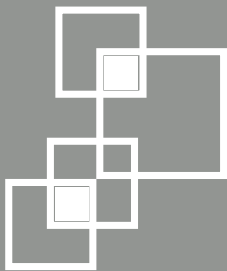

700LED + 701LED

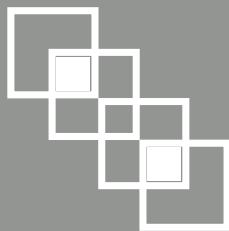

700LED + 700LED

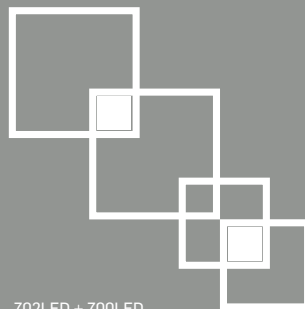

702LED + 700LED

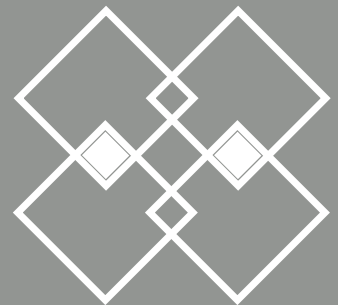

702LED + 702LED



## FIT 25 | pendente

705LED3BT



706LED3PT

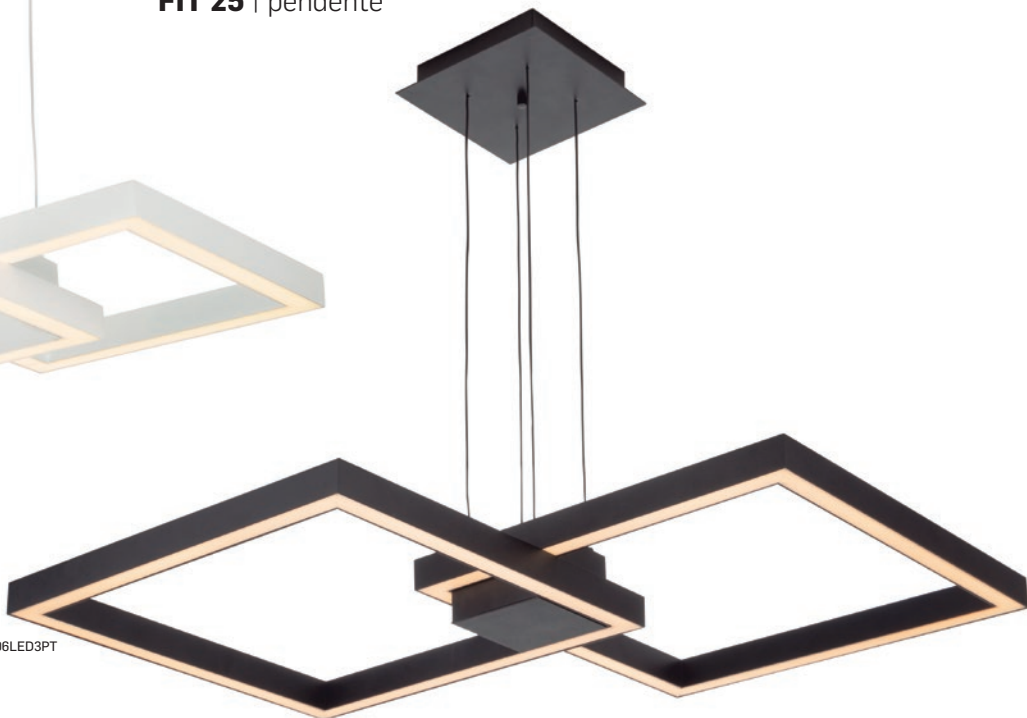

Led LINE

**3 ANOS DE GARANTIA**  
CONTRA DEFEITOS DE FABRICAÇÃO

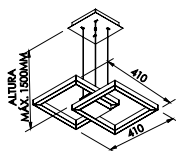

705LED

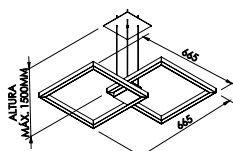

706LED

PENDENTE					
CÓDIGO	POTÊNCIA	FLUXO DA FONTE (lm)	FLUXO DA LUMINÁRIA (lm)	TEMP. COR (K)	DIM. (mm)
705LED3	50,4W	5544	2661	3000 ☉	410 x 410 x 65
705LED4	50,4W	5544	2661	4000 ○	410 x 410 x 65
706LED3	67,2W	7392	3548	3000 ☉	665 x 665 x 65
706LED4	67,2W	7392	3548	4000 ○	665 x 665 x 65

### MATERIAL

Produzido em alumínio  
Difusor de acrílico  
Cabo ajustável de 1,5m  
Consulte todos os acabamentos disponíveis

**PRODUTO BIVOLT (127V/220V)**



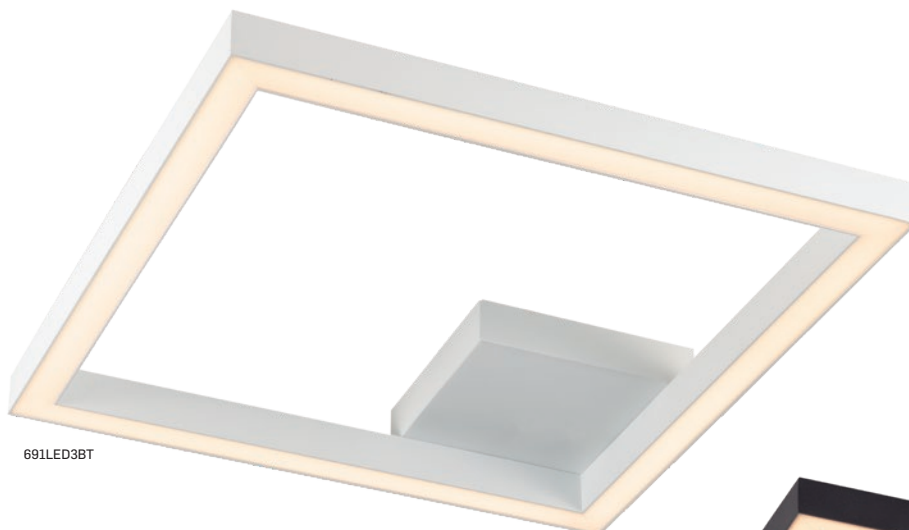

691LED3BT

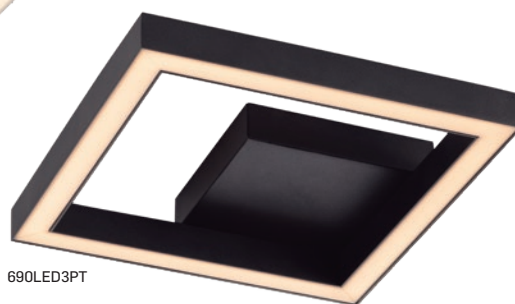

690LED3PT

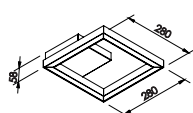

690LED

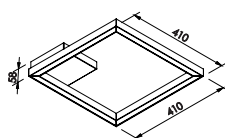

691LED

LedLINE

**3 ANOS DE GARANTIA**  
CONTRA DEFECTOS DE FABRICAÇÃO

PLAFON/ARANDELA					
CÓDIGO	POTÊNCIA	FLUXO DA FONTE (lm)	FLUXO DA LUMINÁRIA (lm)	TEMP. COR (K)	DIM. (mm)
690LED3	25,2W	2772	1331	3000 ☉	280 x 280 x 58
690LED4	25,2W	2772	1331	4000 ○	280 x 280 x 58
691LED3	33,6W	3696	1774	3000 ☉	410 x 410 x 58
691LED4	33,6W	3696	1774	4000 ○	410 x 410 x 58

### MATERIAL

Produzido em alumínio  
Difusor de acrílico  
Consulte todos os acabamentos disponíveis

**PRODUTO BIVOLT (127V/220V)**



## FIT 25 | pendente

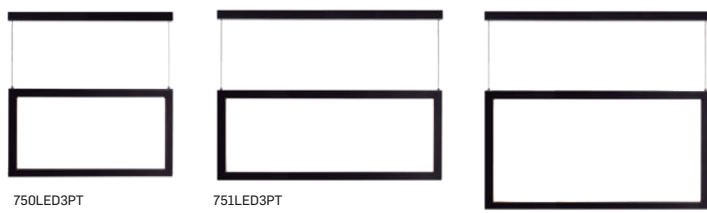

750LED3PT

751LED3PT

752LED3PT

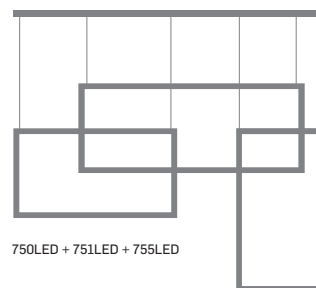

750LED + 751LED + 755LED

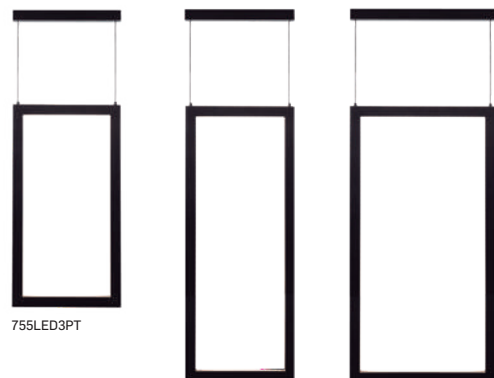

755LED3PT

756LED3PT

757LED3PT

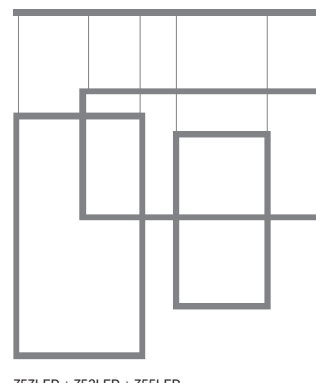

757LED + 752LED + 755LED

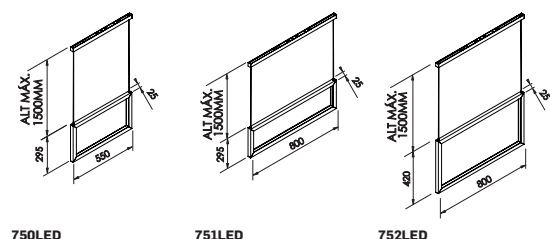

750LED

751LED

752LED

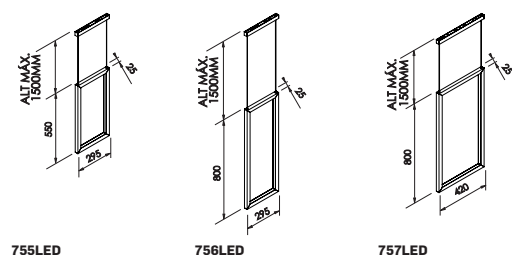

755LED

756LED

757LED



751LED + 752LED + 755LED

PENDENTE					
CÓDIGO	POTÊNCIA	FLUXO DA FONTE (lm)	FLUXO DA LUMINÁRIA (lm)	TEMP. COR (K)	DIM. (mm)
750LED3	18,9W	2079	998	3000 ●	550 x 295 x 28
750LED4	18,9W	2079	998	4000 ○	550 x 295 x 28
751LED3	23,1W	2541	1220	3000 ●	800 x 295 x 28
751LED4	23,1W	2541	1220	4000 ○	800 x 295 x 28
752LED3	25,2W	2772	1331	3000 ●	800 x 420 x 28
752LED4	25,2W	2772	1331	4000 ○	800 x 420 x 28
755LED3	18,9W	2079	998	3000 ●	295 x 550 x 28
755LED4	18,9W	2079	998	4000 ○	295 x 550 x 28
756LED3	23,1W	2541	1220	3000 ●	295 x 800 x 28
756LED4	23,1W	2541	1220	4000 ○	295 x 800 x 28
757LED3	25,2W	2772	1331	3000 ●	420 x 800 x 28
757LED4	25,2W	2772	1331	4000 ○	420 x 800 x 28

LedLINE

**3 ANOS DE GARANTIA**  
CONTRA DEFEITOS DE FABRICAÇÃO

### MATERIAL

Produzido em alumínio  
Difusor de acrílico  
Cabo ajustável de 1,5m  
Consulte todos os acabamentos disponíveis

### PRODUTO BIVOLT (127V/220V)



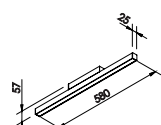
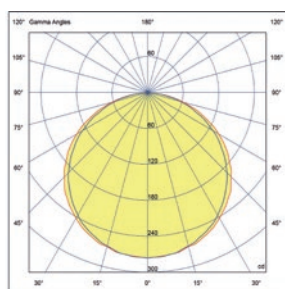

630LED

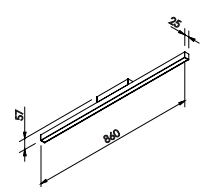
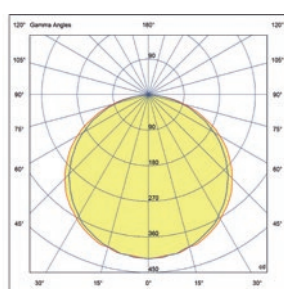

631LED

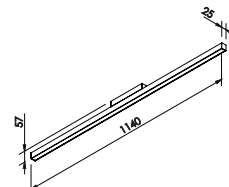
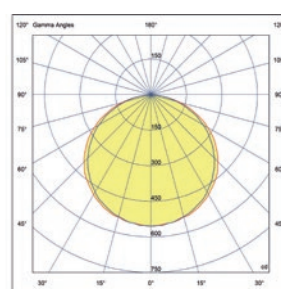

632LED

LedLINE

**3 ANOS DE GARANTIA**  
CONTRA DEFeitos DE FABRICAÇÃO

PLAFON/ARANDELA					
CÓDIGO	POTÊNCIA	FLUXO DA FONTE (lm)	FLUXO DA LUMINÁRIA (lm)	TEMP. COR (K)	DIM. (mm)
630LED3	16W	2200	833	3000 ☉	580 x 25 x 57
630LED4	16W	2200	877	4000 ○	580 x 25 x 57
631LED3	24W	3300	1250	3000 ☉	860 x 25 x 57
631LED4	24W	3300	1316	4000 ○	860 x 25 x 57
632LED3	32W	4400	1672	3000 ☉	1140 x 25 x 57
632LED4	32W	4400	1760	4000 ○	1140 x 25 x 57

### MATERIAL

Produzido em alumínio  
Difusor de acrílico  
Consulte todos os acabamentos disponíveis

**PRODUTO BIVOLT (127V/220V)**



## FIT 25 | plafon/arandela

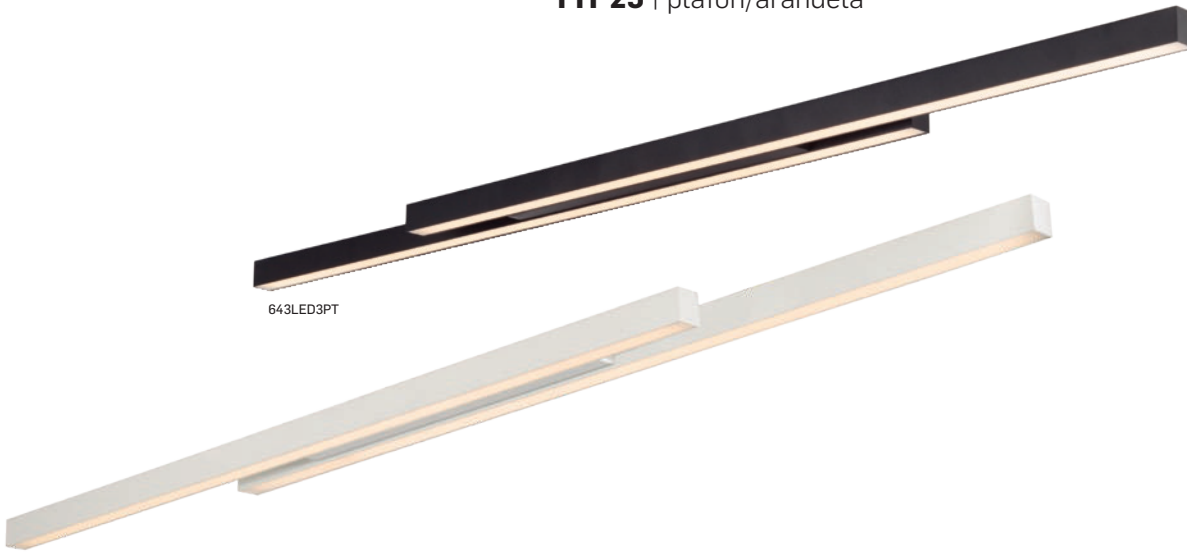

643LED3PT

643LED3BT

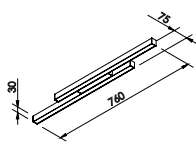
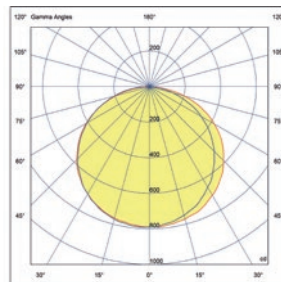
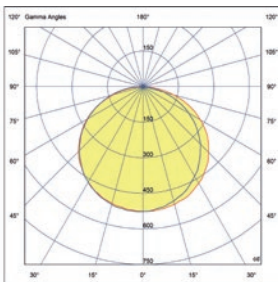

643LED

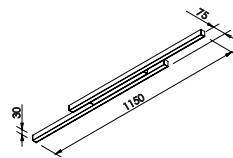

644LED

LedLINE

**3 ANOS DE GARANTIA**  
CONTRA DEFEITOS DE FABRICAÇÃO

### PLAFON/ARANDELA

CÓDIGO	POTÊNCIA	FLUXO DA FONTE (lm)	FLUXO DA LUMINÁRIA (lm)	TEMP. COR (K)	DIM. (mm)
643LED3	32W	4400	1631	3000 ☉	760 x 75 x 30
643LED4	32W	4400	1717	4000 ○	760 x 75 x 30
644LED3	48W	6600	2447	3000 ☉	1150 x 75 x 30
644LED4	48W	6600	2575	4000 ○	1150 x 75 x 30

### MATERIAL

Produzido em alumínio  
Difusor de acrílico  
Consulte todos os acabamentos disponíveis

**PRODUTO BIVOLT (127V/220V)**



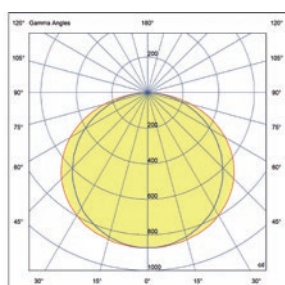
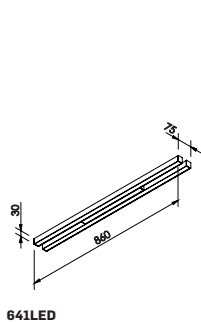
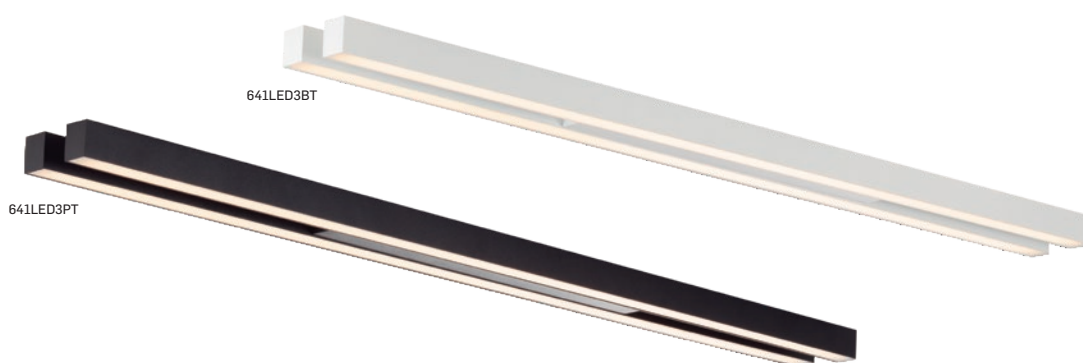

LedLINE

**3 ANOS DE GARANTIA**  
CONTRA DEFEITOS DE FABRICAÇÃO

### MATERIAL

Produzido em alumínio  
Difusor de acrílico  
Consulte todos os acabamentos disponíveis

**PRODUTO BIVOLT (127V/220V)**

PLAFON/ARANDELA					
CÓDIGO	POTÊNCIA	FLUXO DA FONTE (lm)	FLUXO DA LUMINÁRIA (lm)	TEMP. COR (K)	DIM. (mm)
641LED3	48W	6600	2787	3000 ☉	860 x 75 x 30
641LED4	48W	6600	2934	4000 ○	860 x 75 x 30



## FIT 25 | arandela

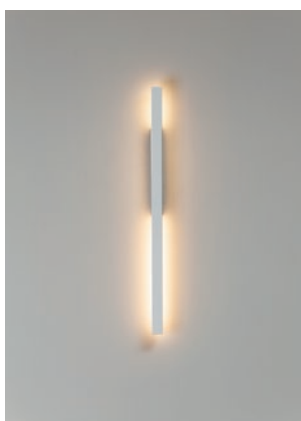

655LED3BT



656LED3PT



657LED3CO

CANOPLA DESLOCADA

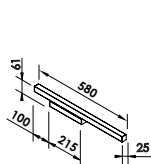
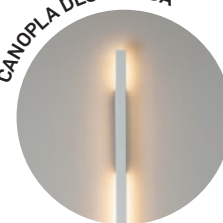

655LED

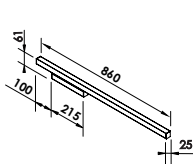

656LED

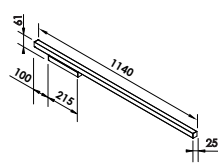

657LED

LedLINE

**3 ANOS DE GARANTIA**  
CONTRA DEFEITOS DE FABRICAÇÃO

PLAFON/ARANDELA					
CÓDIGO	POTÊNCIA	FLUXO DA FONTE (lm)	FLUXO DA LUMINÁRIA (lm)	TEMP. COR (K)	DIM. (mm)
655LED3	16W	2200	880	3000 ☉	580 x 61 x 25
655LED4	16W	2200	880	4000 ○	580 x 61 x 25
656LED3	24W	3300	1320	3000 ☉	860 x 61 x 25
656LED4	24W	3300	1320	4000 ○	860 x 61 x 25
657LED3	32W	4400	1760	3000 ☉	1140 x 61 x 25
657LED4	32W	4400	1760	4000 ○	1140 x 61 x 25

### MATERIAL

Produzido em alumínio  
Difusor de acrílico  
Consulte todos os acabamentos disponíveis

**PRODUTO BIVOLT (127V/220V)**





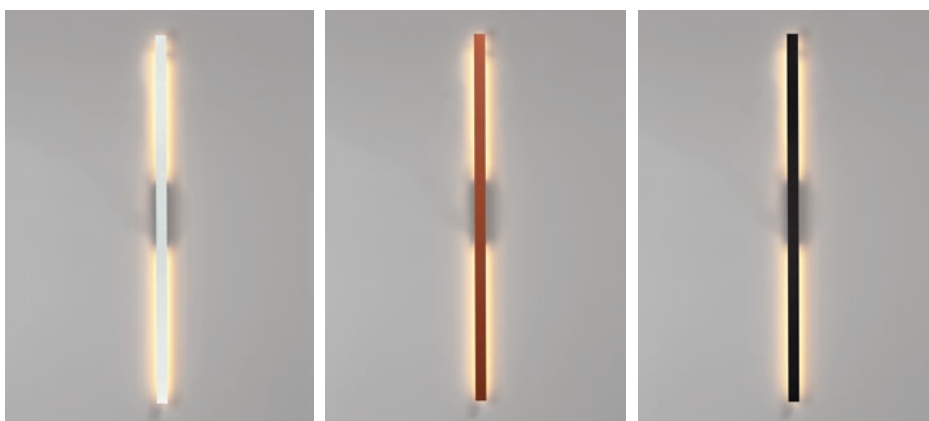

646LED3BT

646LED3CO

646LED3PT

CANOPLA CENTRALIZADA

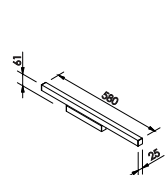
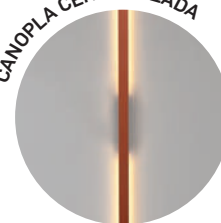

645LED

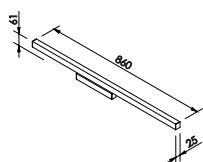

646LED

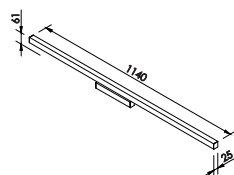

647LED

LedLINE

**3 ANOS DE GARANTIA**  
CONTRA DEFETOS DE FABRICAÇÃO

PLAFON/ARANDELA					
CÓDIGO	POTÊNCIA	FLUXO DA FONTE (lm)	FLUXO DA LUMINÁRIA (lm)	TEMP. COR (K)	DIM. (mm)
645LED3	16W	2200	880	3000 ☉	580 x 61 x 25
645LED4	16W	2200	880	4000 ○	580 x 61 x 25
646LED3	24W	3300	1320	3000 ☉	860 x 61 x 25
646LED4	24W	3300	1320	4000 ○	860 x 61 x 25
647LED3	32W	4400	1760	3000 ☉	1140 x 61 x 25
647LED4	32W	4400	1760	4000 ○	1140 x 61 x 25

### MATERIAL

Produzido em alumínio  
Difusor de acrílico  
Consulte todos os acabamentos disponíveis

**PRODUTO BIVOLT (127V/220V)**



## FIT 25 | pendente



636LED3PT

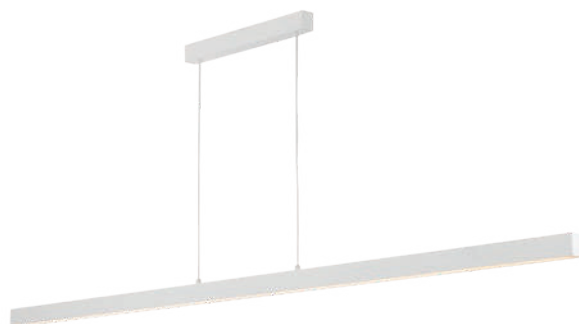

637LED3BT

Led LINE

**3 ANOS DE GARANTIA**  
CONTRA DEFETOS DE FABRICAÇÃO

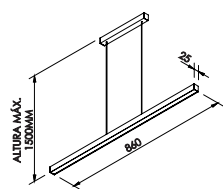
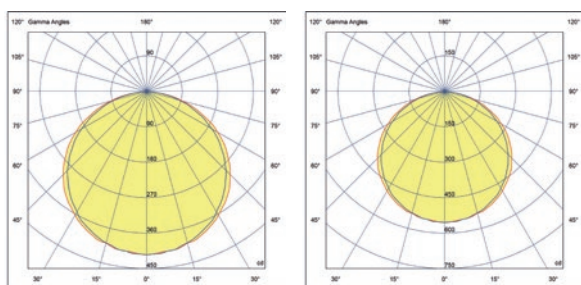

636LED

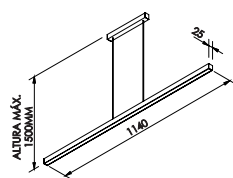

637LED



PENDENTE					
CÓDIGO	POTÊNCIA	FLUXO DA FONTE (lm)	FLUXO DA LUMINÁRIA (lm)	TEMP. COR (K)	DIM. (mm)
636LED3	24W	3300	1250	3000 ☉	860 x 25 x 28
636LED4	24W	3300	1316	4000 ○	860 x 25 x 28
637LED3	32W	4400	1672	3000 ☉	1140 x 25 x 28
637LED4	32W	4400	1760	4000 ○	1140 x 25 x 28

## MATERIAL

Produzido em alumínio  
Difusor de acrílico  
Cabo ajustável de 1,5m  
Consulte todos os acabamentos disponíveis

**PRODUTO BIVOLT (127V/220V)**



## FIT 25 | pendente

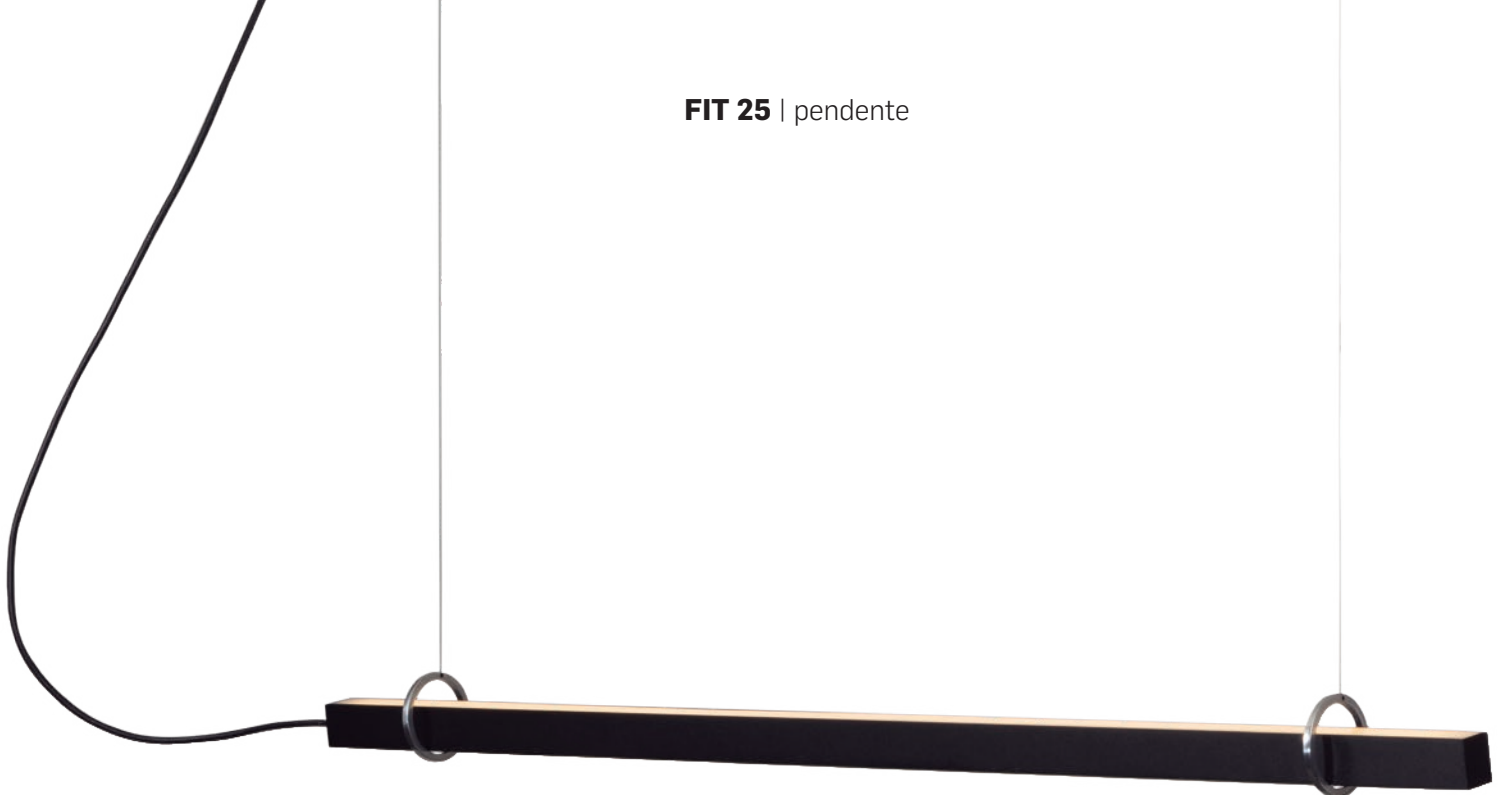

662LED3PT

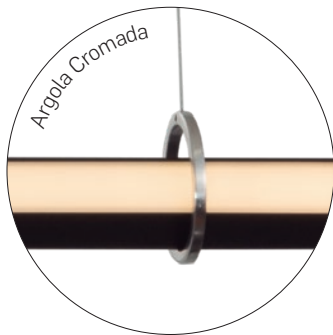

LedLINE

**3 ANOS DE GARANTIA**  
CONTRA DEFETOS DE FABRICAÇÃO

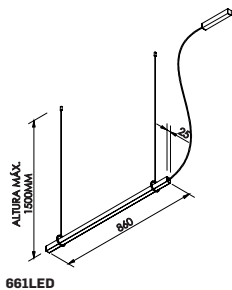
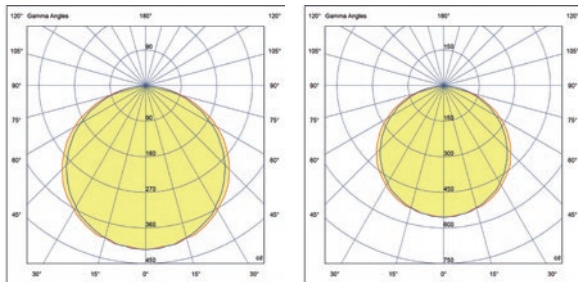

661LED

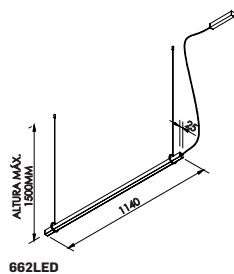

662LED



PENDENTE					
CÓDIGO	POTÊNCIA	FLUXO DA FONTE (lm)	FLUXO DA LUMINÁRIA (lm)	TEMP. COR (K)	DIM. (mm)
661LED3	24W	3300	1250	3000 ☉	860 x 25 x 28
661LED4	24W	3300	1316	4000 ○	860 x 25 x 28
662LED3	32W	4400	1672	3000 ☉	1140 x 25 x 28
662LED4	32W	4400	1760	4000 ○	1140 x 25 x 28

### MATERIAL

Produzido em alumínio  
Difusor de acrílico  
Cabo ajustável de 1,5m  
Consulte todos os acabamentos disponíveis

**PRODUTO BIVOLT (127V/220V)**



**FIT 25** | plafon/arandela

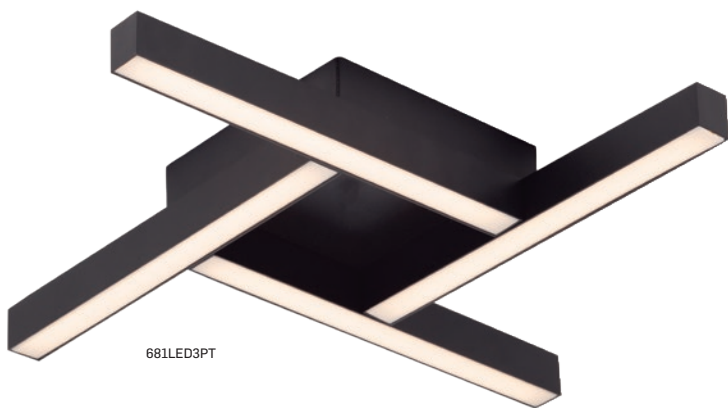

681LED3PT

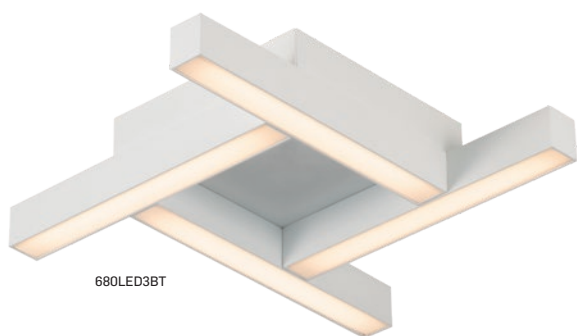

680LED3BT

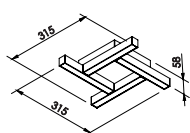

680LED

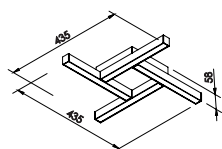

681LED



**3 ANOS DE GARANTIA**  
CONTRA DEFECTOS DE FABRICAÇÃO

PLAFON/ARANDELA					
CÓDIGO	POTÊNCIA	FLUXO DA FONTE (lm)	FLUXO DA LUMINÁRIA (lm)	TEMP. COR (K)	DIM. (mm)
680LED3	16,8W	1840	883	3000 ☉	315 x 315 x 58
680LED4	16,8W	1840	883	4000 ○	315 x 315 x 58
681LED3	25,2W	2772	1331	3000 ☉	435 x 435 x 58
681LED4	25,2W	2772	1331	4000 ○	435 x 435 x 58

**MATERIAL**

Produzido em alumínio  
Difusor de acrílico  
Consulte todos os acabamentos disponíveis

**PRODUTO BIVOLT (127V/220V)**



## FIT 25 | plafon/arandela

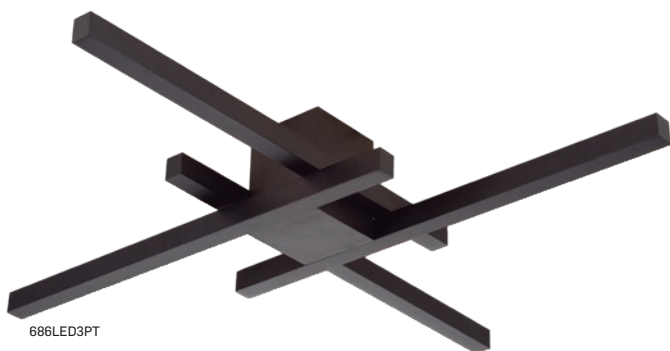

686LED3PT

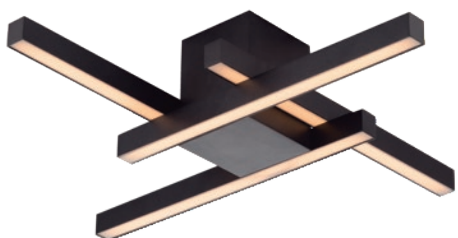

685LED3PT

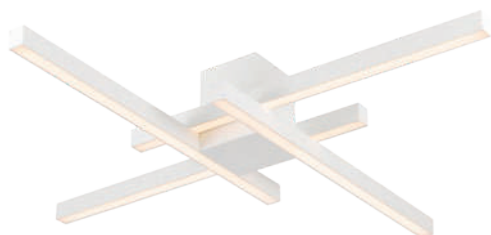

686LED3BT

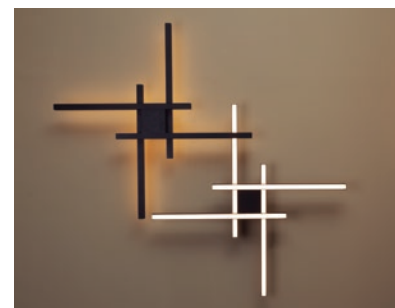

O mesmo produto,  
duas possibilidades  
de montagem

**LUZ DIRETA**  
OU **INDIRETA**

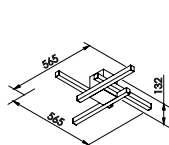

685LED

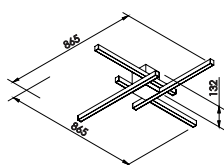

686LED

### PLAFON/ARANDELA

CÓDIGO	POTÊNCIA	FLUXO DA FONTE (lm)	FLUXO DA LUMINÁRIA (lm)	TEMP. COR (K)	DIM. (mm)
685LED3	33,6W	3696	1774	3000 ☉	565 x 565 x 132
685LED4	33,6W	3696	1774	4000 ○	565 x 565 x 132
686LED3	50,4W	5536	2657	3000 ☉	865 x 865 x 132
686LED4	50,4W	5536	2657	4000 ○	865 x 865 x 132

LedLINE

**3 ANOS DE GARANTIA**  
CONTRA DEFEITOS DE FABRICAÇÃO

### MATERIAL

Produzido em alumínio  
Difusor de acrílico  
Consulte todos os acabamentos disponíveis

**PRODUTO BIVOLT (127V/220V)**



**FIT 25** | pendente



711LED3PT



710LED3BT



711LED3DO



**Led**LINE

**3 ANOS DE GARANTIA**  
CONTRA DEFETOS DE FABRICAÇÃO

**MATERIAL**

Produzido em alumínio  
Difusor de acrílico  
Cabo ajustável de 1,5m  
Consulte todos os acabamentos disponíveis

**PRODUTO BIVOLT (127V/220V)**

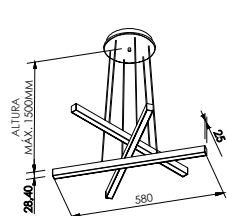

710LED

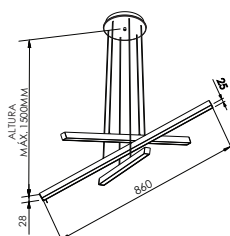

711LED

PENDENTE					
CÓDIGO	POTÊNCIA	FLUXO DA FONTE (lm)	FLUXO DA LUMINÁRIA (lm)	TEMP. COR (K)	DIM. (mm)
710LED3	16W	2200	880	3000 ☉	580 x 25 x 28
710LED4	16W	2200	880	4000 ○	580 x 25 x 28
711LED3	24W	3300	1320	3000 ☉	860 x 25 x 28
711LED4	24W	3300	1320	4000 ○	860 x 25 x 28



## FIT 25 | pendente



715LED3PT

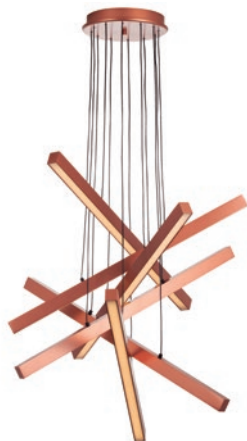

715LED3CO

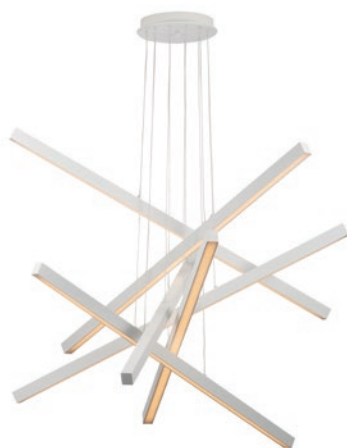

716LED3BT



716LED3DO

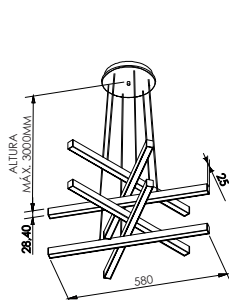

715LED

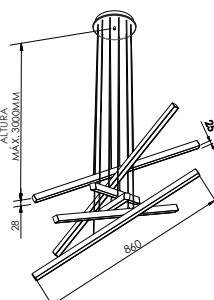

716LED



LedLINE

**3 ANOS DE GARANTIA**  
CONTRA DEFETOS DE FABRICAÇÃO

PENDENTE					
CÓDIGO	POTÊNCIA	FLUXO DA FONTE (lm)	FLUXO DA LUMINÁRIA (lm)	TEMP. COR (K)	DIM. (mm)
715LED3	32W	4400	1760	3000 ☉	580 x 25 x 28
715LED4	32W	4400	1760	4000 ○	580 x 25 x 28
716LED3	48W	6600	2640	3000 ☉	860 x 25 x 28
716LED4	48W	6600	2640	4000 ○	860 x 25 x 28

### MATERIAL

Produzido em alumínio  
Difusor acrílico  
Cabo ajustável de 3m  
Consulte todos os acabamentos disponíveis

**PRODUTO BIVOLT (127V/220V)**



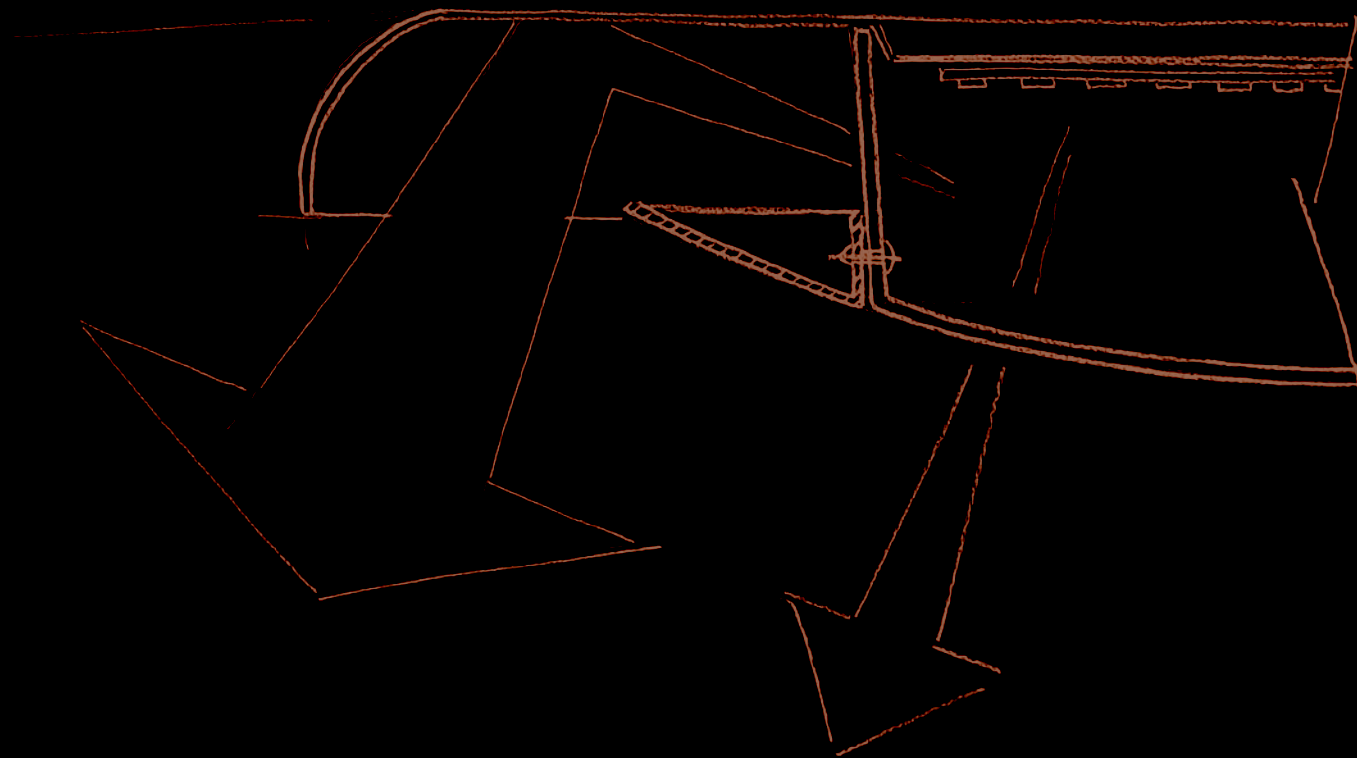
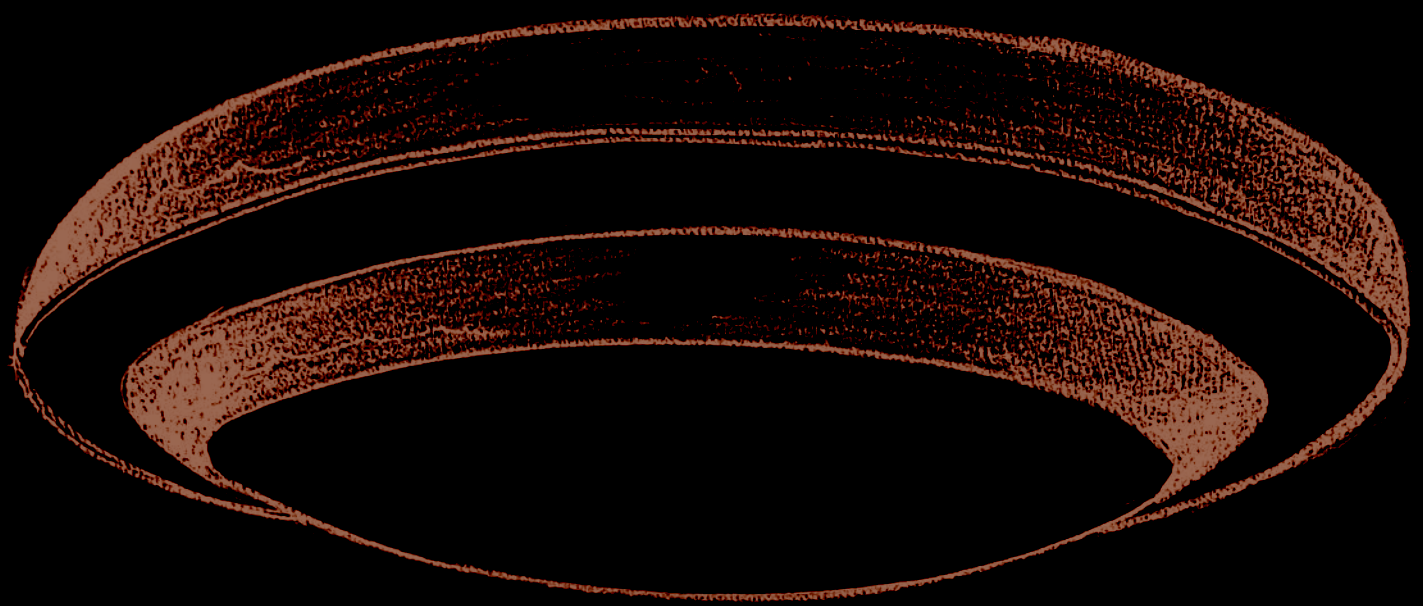





PLAFON E PENDENTE  
**SPIN**

**Uma peça para iluminar e decorar**

A linha Spin mescla a luz direta difusa com a luz refletida, resultando em uma iluminação confortável e funcional. Podendo ser trabalhado em dois acabamentos diferentes, os plafons e pendentes Spin são verdadeiros objetos de decoração para complementar os projetos mais modernos.

Designed by



**MARCO DIAS**

Designer de produtos, nascido em São Paulo e formado pela FAAP (Fundação Álvares Penteado) em Desenho Industrial. Atuou em empresas como Dominici e Studioluca. É o designer titular da Newline desde 2006.



PL02004LED3PTBT



PL02004LED3DODO



PL02005LED3BTBT



PL02005LED3PTPT

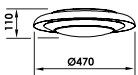
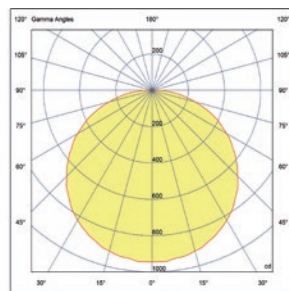
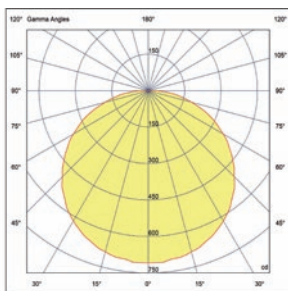

PL02004LED

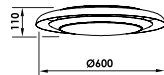

PL02005LED

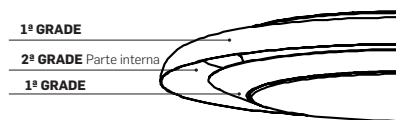

LedLINE

**3 ANOS DE GARANTIA**  
CONTRA DEFETOS DE FABRICAÇÃO

**PLAFON SPIN**

CÓDIGO	POTÊNCIA	FLUXO DA FONTE (lm)	FLUXO DA LUMINÁRIA (lm)	TEMP. COR (K)	DIM. (mm)
PL02004LED3	25,2W	3348	2226	3000 ☉	470 x 470 x 110
PL02004LED4	25,2W	3348	2226	4000 ○	470 x 470 x 110
PL02005LED3	33,6W	4464	3021	3000 ☉	600 x 600 x 110
PL02005LED4	33,6W	4464	3021	4000 ○	600 x 600 x 110

**MATERIAL**

Produzido em alumínio  
Difusor opalino  
Consulte todos os acabamentos disponíveis

**PRODUTO BIVOLT (127V/220V)**







PD02004LED3BTBT



PD02005LED3PTBT



PD02005LED3D0BT



PD02005LED3D0DO

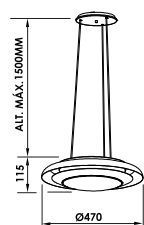
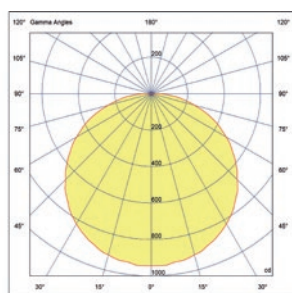
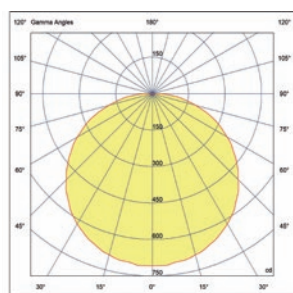

PD02004LED

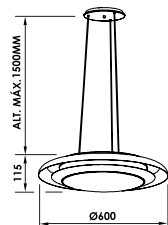

PD02005LED

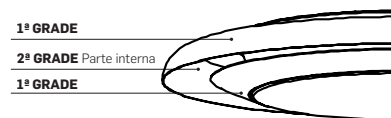

LedLINE

**3 ANOS DE GARANTIA**  
CONTRA DEFECTOS DE FABRICAÇÃO

PENDENTE SPIN					
CÓDIGO	POTÊNCIA	FLUXO DA FONTE (lm)	FLUXO DA LUMINÁRIA (lm)	TEMP. COR (K)	DIM. (mm)
PD02004LED3	25,2W	3348	2226	3000 ☉	470 x 470 x 115
PD02004LED4	25,2W	3348	2226	4000 ○	470 x 470 x 115
PD02005LED3	33,6W	4464	3021	3000 ☉	600 x 600 x 115
PD02005LED4	33,6W	4464	3021	4000 ○	600 x 600 x 115

**MATERIAL**

Produzido em alumínio  
Difusor opalino  
Consulte todos os acabamentos disponíveis

**PRODUTO BIVOLT (127V/220V)**







PL02002LED3BT



PL02002LED3PT



PL02003LED3DO

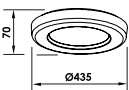
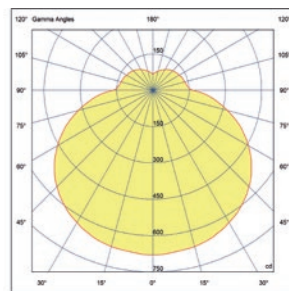
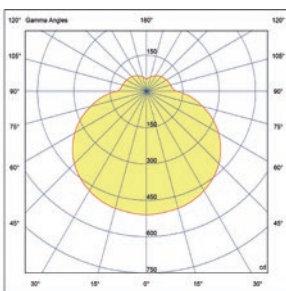

PL02002LED

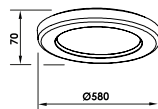

PL02003LED



**3 ANOS DE GARANTIA**  
CONTRA DEFETOS DE FABRICAÇÃO

PLAFON SHAPE					
CÓDIGO	POTÊNCIA	FLUXO DA FONTE (lm)	FLUXO DA LUMINÁRIA (lm)	TEMP. COR (K)	DIM. (mm)
PL02002LED3	25,2W	3348	2682	3000 ☉	435 x 435 x 70
PL02002LED4	25,2W	3348	2682	4000 ○	435 x 435 x 70
PL02003LED3	33,6W	4464	3576	3000 ☉	580 x 580 x 70
PL02003LED4	33,6W	4464	3576	4000 ○	580 x 580 x 70

**MATERIAL**

Produzido em alumínio  
Difusor opalino  
Consulte todos os acabamentos disponíveis

**PRODUTO BIVOLT (127V/220V)**





# APOLLO | plafon



580LED4BT



581LED4PT



582LED4FF

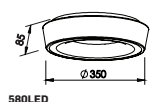
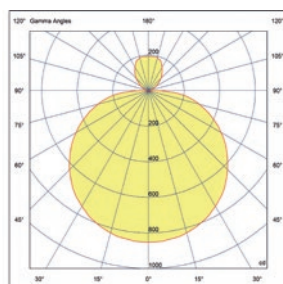
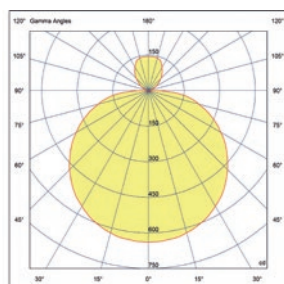
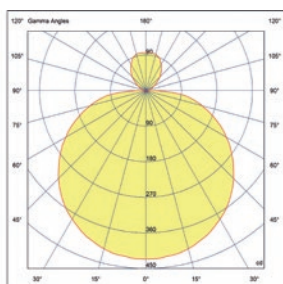

580LED

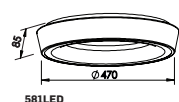

581LED

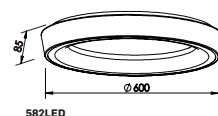

582LED

LedLINE

**3 ANOS DE GARANTIA**  
CONTRA DEFECTOS DE FABRICAÇÃO

PLAFON					
CÓDIGO	POTÊNCIA	FLUXO DA FONTE (lm)	FLUXO DA LUMINÁRIA (lm)	TEMP. COR (K)	DIM. (mm)
580LED3	16,8W	2232	1692	3000 ☉	Ø350 x 85
580LED4	16,8W	2232	1781	4000 ○	Ø350 x 85
581LED3	25,2W	3348	2538	3000 ☉	Ø470 x 85
581LED4	25,2W	3348	2672	4000 ○	Ø470 x 85
582LED3	33,6W	4464	3384	3000 ☉	Ø600 x 85
582LED4	33,6W	4464	3563	4000 ○	Ø600 x 85

## MATERIAL

Produzido em alumínio  
Difusor opalino  
Consulte todos os acabamentos disponíveis

**PRODUTO BIVOLT (127V/220V)**







## APOLLO | pendente

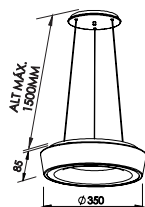
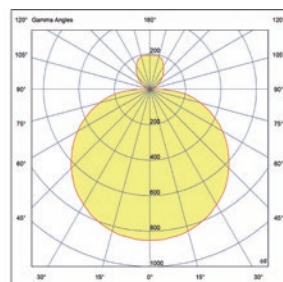
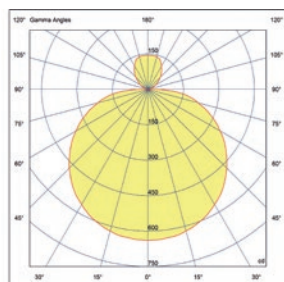
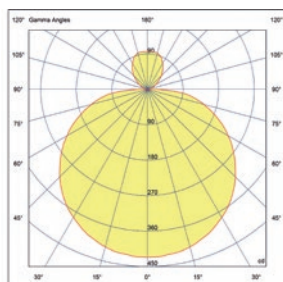
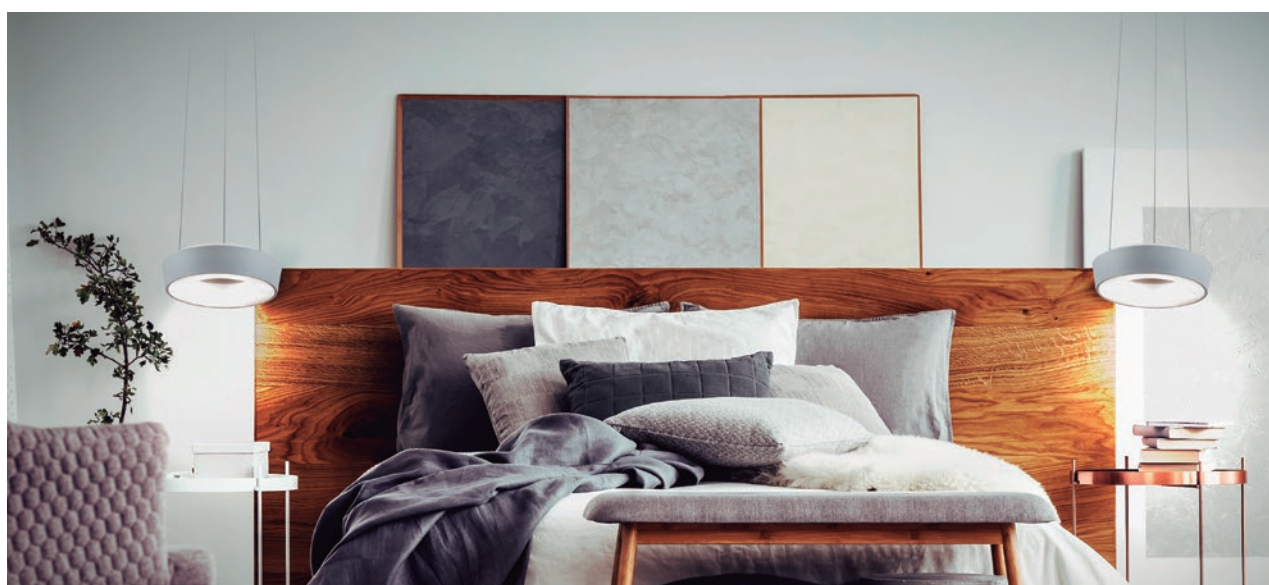

585LED

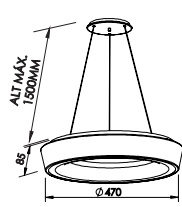

586LED

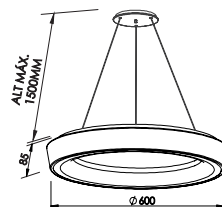

587LED

LedLINE

**3 ANOS DE GARANTIA**  
CONTRA DEFEITOS DE FABRICAÇÃO

PENDENTE					
CÓDIGO	POTÊNCIA	FLUXO DA FONTE (lm)	FLUXO DA LUMINÁRIA (lm)	TEMP. COR (K)	DIM. (mm)
585LED3	16,8W	2232	1692	3000 ☉	Ø350 x 85
585LED4	16,8W	2232	1781	4000 ○	Ø350 x 85
586LED3	25,2W	3348	2538	3000 ☉	Ø470 x 85
586LED4	25,2W	3348	2672	4000 ○	Ø470 x 85
587LED3	33,6W	4464	3384	3000 ☉	Ø600 x 85
587LED4	33,6W	4464	3563	4000 ○	Ø600 x 85

### MATERIAL

Produzido em alumínio  
Difusor opalino  
Cabo ajustável de 1,5m  
Consulte todos os acabamentos disponíveis

**PRODUTO BIVOLT (127V/220V)**





# NEW CHESS | embutido

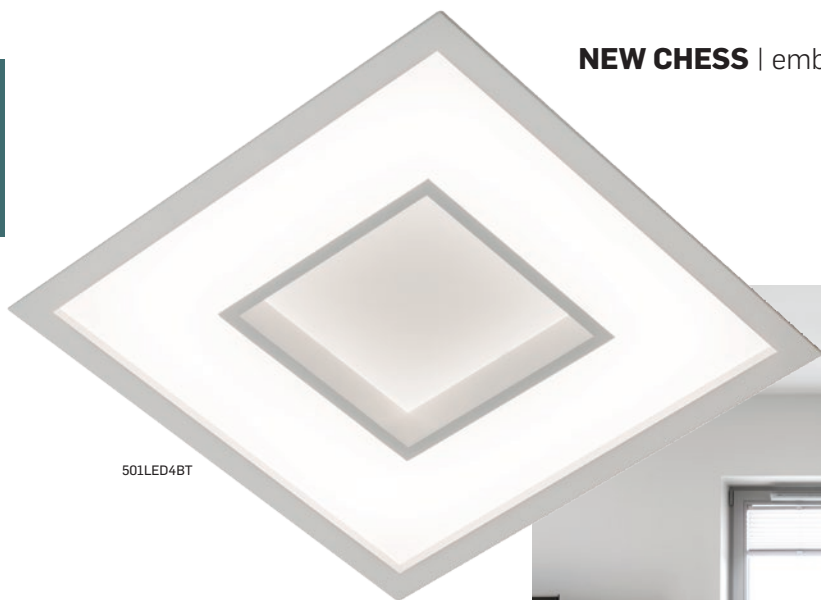

501LED4BT

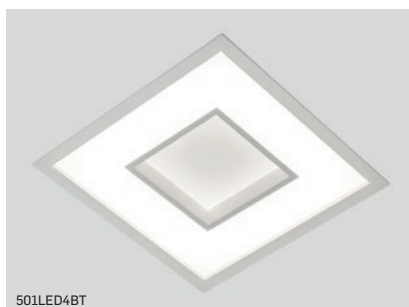

501LED4BT

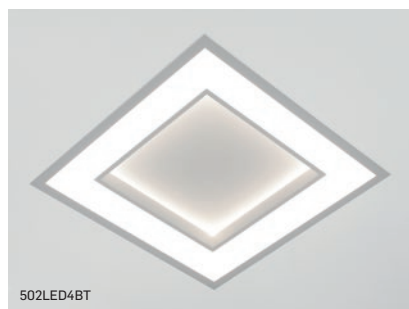

502LED4BT

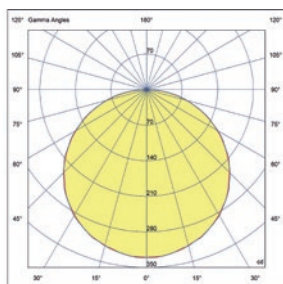

500LED

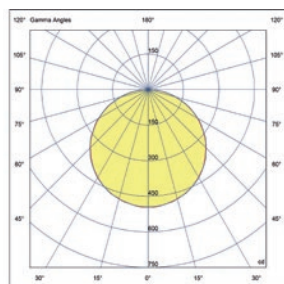

501LED

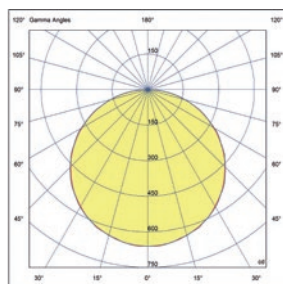

502LED

LedLINE

**3 ANOS DE GARANTIA**  
CONTRA DEFETOS DE FABRICAÇÃO

## EMBUITO

CÓDIGO	POTÊNCIA	FLUXO DA FONTE (lm)	FLUXO DA LUMINÁRIA (lm)	TEMP. COR (K)	DIM. (mm)	NICHO (mm)
500LED3	16,8W	2232	1021	3000 ☉	285 x 285 x 67	270 x 270
500LED4	16,8W	2232	1075	4000 ○	285 x 285 x 67	270 x 270
501LED3	25,2W	3348	1532	3000 ☉	370 x 370 x 67	355 x 355
501LED4	25,2W	3348	1612	4000 ○	370 x 370 x 67	355 x 355
502LED3	33,6W	4464	2043	3000 ☉	490 x 490 x 67	475 x 475
502LED4	33,6W	4464	2150	4000 ○	490 x 490 x 67	475 x 475

## MATERIAL

Produzido em alumínio  
Difusor opalino  
Consulte todos os acabamentos disponíveis

**PRODUTO BIVOLT (127V/220V)**



## NEW CHESS | plafon

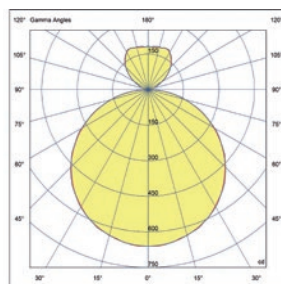
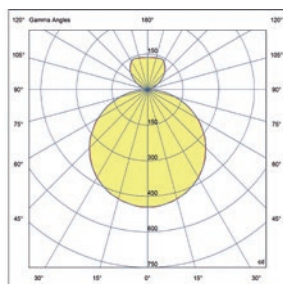
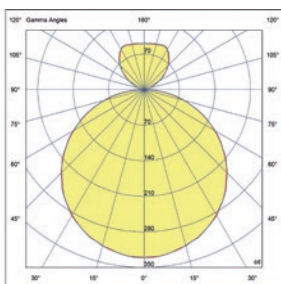

510LED

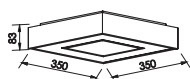

511LED

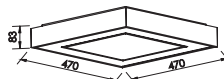

512LED

LedLINE

**3 ANOS DE GARANTIA**  
CONTRA DEFECTOS DE FABRICAÇÃO

### PLAFON

CÓDIGO	POTÊNCIA	FLUXO DA FONTE (lm)	FLUXO DA LUMINÁRIA (lm)	TEMP. COR (K)	DIM. (mm)
510LED3	16,8W	2232	1309	3000 ☉	265 x 265 x 83
510LED4	16,8W	2232	1378	4000 ○	265 x 265 x 83
511LED3	25,2W	3348	1964	3000 ☉	350 x 350 x 83
511LED4	25,2W	3348	2067	4000 ○	350 x 350 x 83
512LED3	33,6W	4464	2618	3000 ☉	470 x 470 x 83
512LED4	33,6W	4464	2756	4000 ○	470 x 470 x 83

### MATERIAL

Produzido em alumínio  
Difusor opalino  
Consulte todos os acabamentos disponíveis

**PRODUTO BIVOLT (127V/220V)**



**NEW CHESS** | pendente

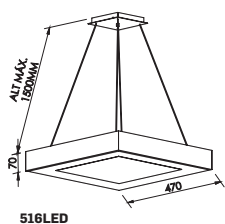
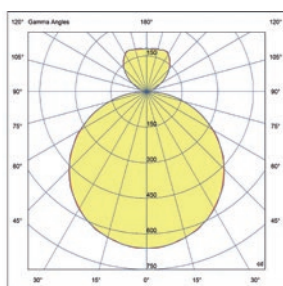
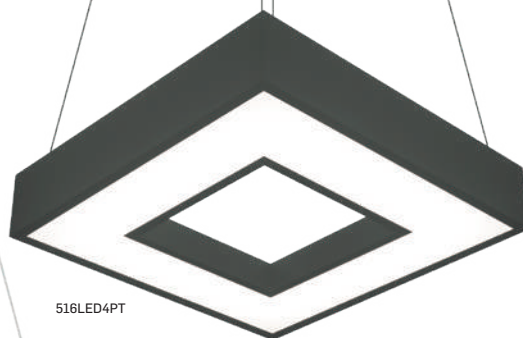
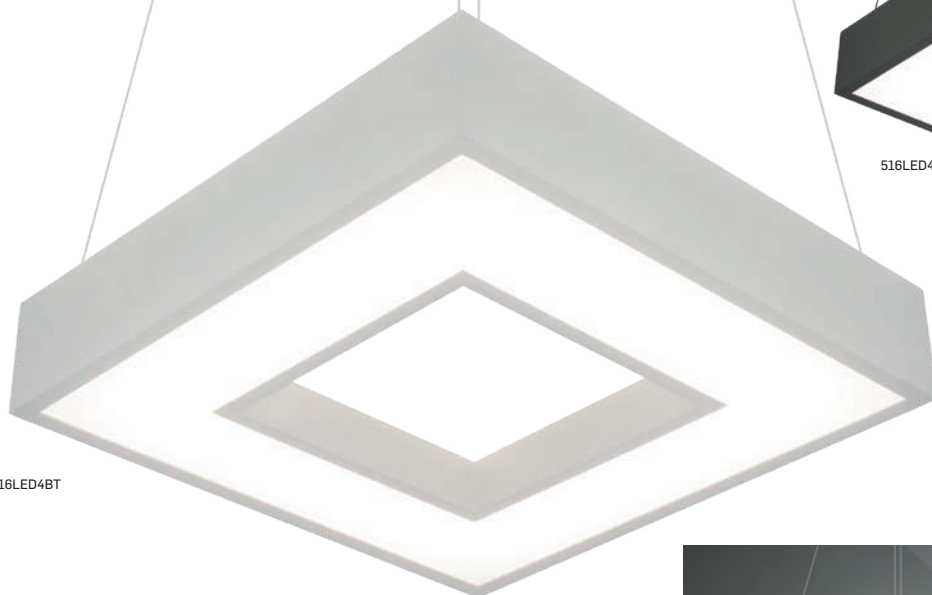

LedLINE

**3 ANOS DE GARANTIA**  
CONTRA DEFETOS DE FABRICAÇÃO

PENDENTE					
CÓDIGO	POTÊNCIA	FLUXO DA FONTE (lm)	FLUXO DA LUMINÁRIA (lm)	TEMP. COR (K)	DIM. (mm)
516LED3	33,6W	4464	2618	3000 ☉	470 x 470 x 70
516LED4	33,6W	4464	2756	4000 ☉	470 x 470 x 70

**MATERIAL**

Produzido em alumínio  
Difusor opalino  
Cabo ajustável de 1,5m  
Consulte todos os acabamentos disponíveis

**PRODUTO BIVOLT (127V/220V)**



## SOBREPOR II | plafon

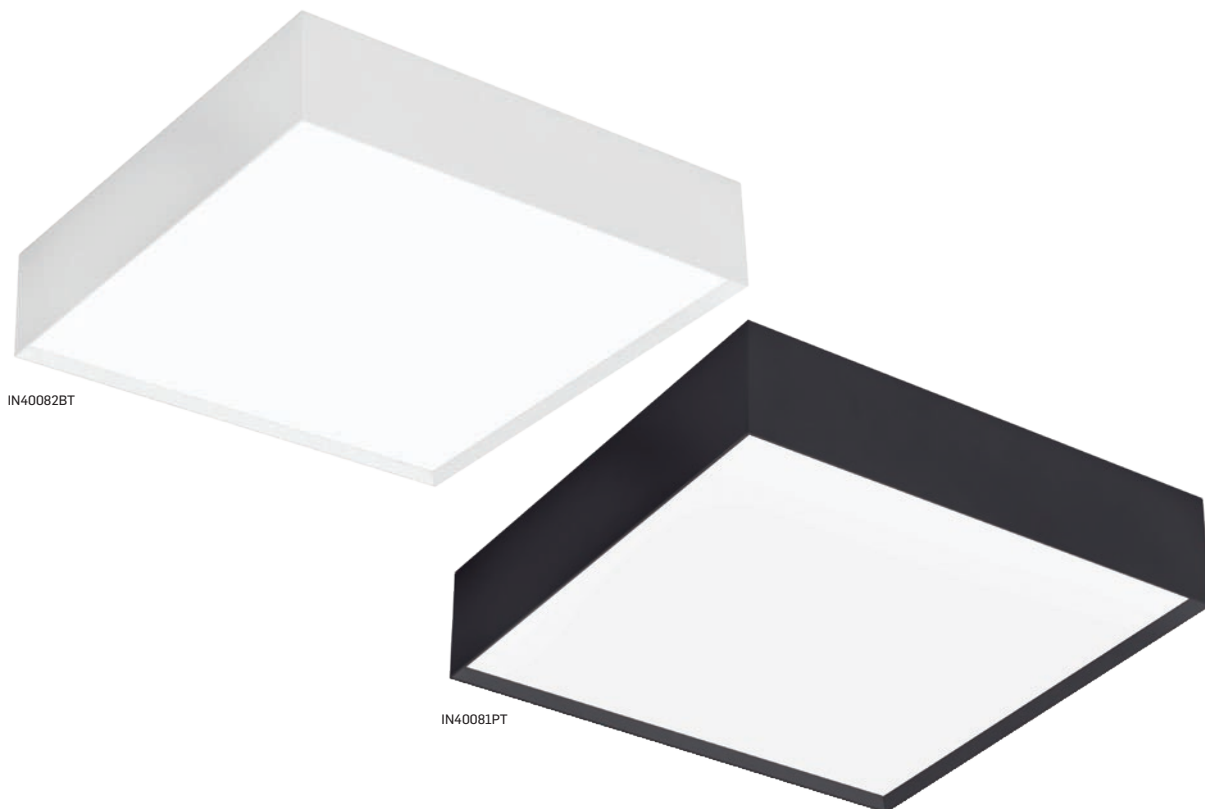

IN40082BT

IN40081PT

**3 ANOS DE GARANTIA**  
CONTRA DEFEITOS DE FABRICAÇÃO



IN40080BT

IN40081PT

IN40082BT

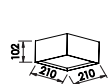

IN40080

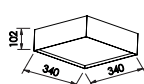

IN40081

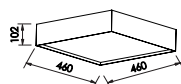

IN40082

PLAFON				
CÓDIGO	QUANT. LAMP.	LÂMPADA	POT. MÁX.	DIM. (mm)
IN40080	2 x E27	CFL	50W	210 x 210 x 102
IN40081	4 x E27	CFL	100W	340 x 340 x 102
IN40082	6 x E27	CFL	150W	460 x 460 x 102



### MATERIAL

Produzido em alumínio  
Difusor opalino  
Consulte todos os acabamentos disponíveis

**PRODUTO BIVOLT (127V/220V)**  
Depende da lâmpada utilizada





490LED4BT



492LED4PT



491LED4BT



493LED4BT

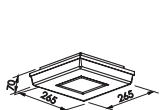

490LED

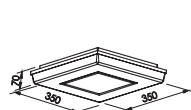

491LED

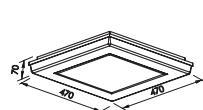

492LED

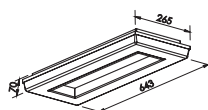

493LED

Led LINE

**3 ANOS DE GARANTIA**  
CONTRA DEFECTOS DE FABRICAÇÃO

PLAFON					
CÓDIGO	POTÊNCIA	FLUXO DA FONTE (lm)	FLUXO DA LUMINÁRIA (lm)	TEMP. COR (K)	DIM. (mm)
490LED3	16,8W	1840	1104	3000 ☉	265 x 265 x 70
490LED4	16,8W	1840	1104	4000 ○	265 x 265 x 70
491LED3	25,2W	2772	1663	3000 ☉	350 x 350 x 70
491LED4	25,2W	2772	1663	4000 ○	350 x 350 x 70
492LED3	33,6W	3693	2216	3000 ☉	470 x 470 x 70
492LED4	33,6W	3693	2216	4000 ○	470 x 470 x 70
493LED3	33,6W	3693	2216	3000 ☉	643 x 265 x 70
493LED4	33,6W	3693	2216	4000 ○	643 x 265 x 70

**MATERIAL**

Produzido em alumínio  
Difusor opalino  
Consulte todos os acabamentos disponíveis

**PRODUTO BIVOLT (127V/220V)**







496LED3PT



496LED3BT

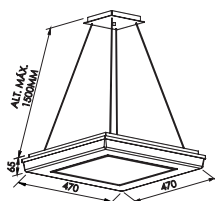

496LED

PENDENTE					
CÓDIGO	POTÊNCIA	FLUXO DA FONTE (lm)	FLUXO DA LUMINÁRIA (lm)	TEMP. COR (K)	DIM. (mm)
496LED3	33,6W	3693	2216	3000 ☉	470 x 470 x 65
496LED4	33,6W	3693	2216	4000 ☉	470 x 470 x 65

LedLINE

**3 ANOS DE GARANTIA**  
CONTRA DEFECTOS DE FABRICAÇÃO

#### MATERIAL

Produzido em alumínio  
Difusor opalino  
Cabo com ajuste de 1,5m  
Consulte todos os acabamentos disponíveis

**PRODUTO BIVOLT (127V/220V)**



## NEW MASSU | embutido

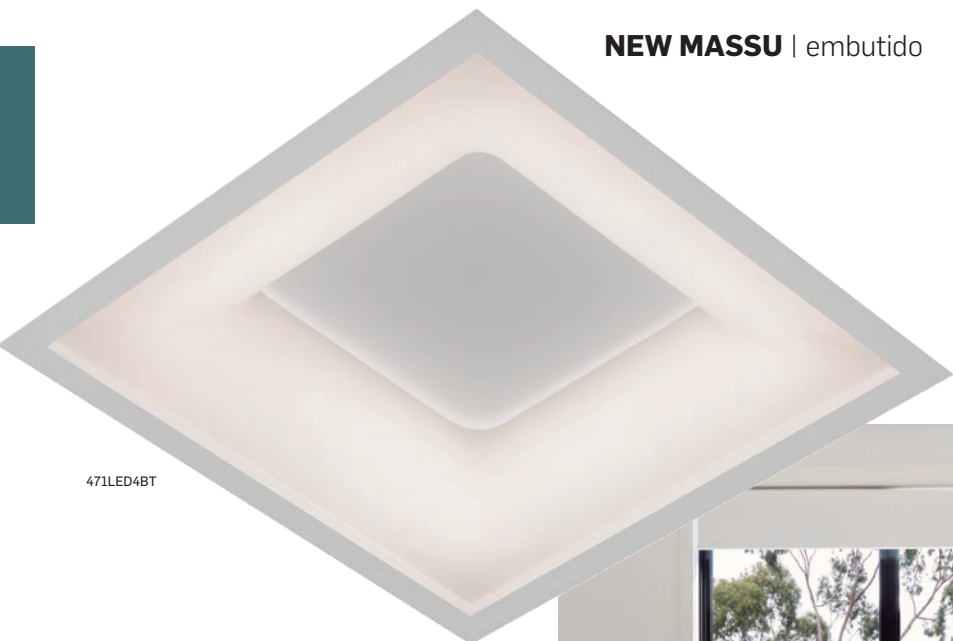

471LED4BT

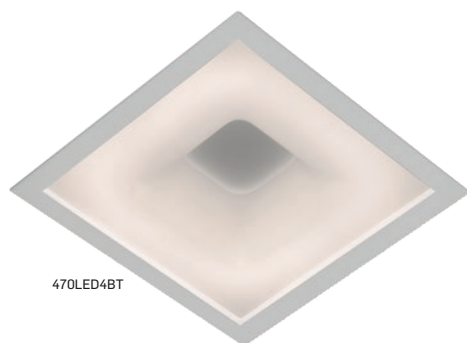

470LED4BT

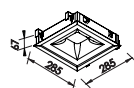
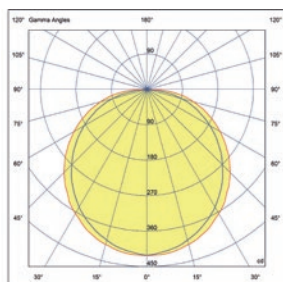

470LED

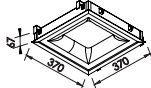
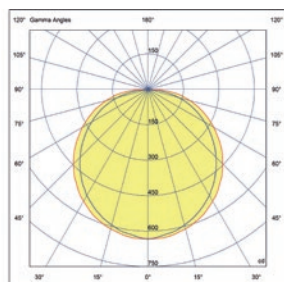

471LED

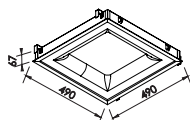
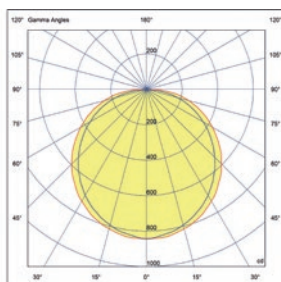

472LED

Led LINE

**3 ANOS DE GARANTIA**  
CONTRA DEFETOS DE FABRICAÇÃO

EMBUITO						
CÓDIGO	POTÊNCIA	FLUXO DA FONTE (lm)	FLUXO DA LUMINÁRIA (lm)	TEMP. COR (K)	DIM. (mm)	NICHO (mm)
470LED3	16,8W	2232	928	3000 ☉	285 x 285 x 67	270 x 270
470LED4	16,8W	2232	977	4000 ○	285 x 285 x 67	270 x 270
471LED3	25,2W	3348	1393	3000 ☉	370 x 370 x 67	355 x 355
471LED4	25,2W	3348	1466	4000 ○	370 x 370 x 67	355 x 355
472LED3	33,6W	4464	1857	3000 ☉	490 x 490 x 67	475 x 475
472LED4	33,6W	4464	1953	4000 ○	490 x 490 x 67	475 x 475

### MATERIAL

Produzido em alumínio  
Difusor opalino  
Consulte todos os acabamentos disponíveis

**PRODUTO BIVOLT (127V/220V)**



## NEW MASSU | plafon

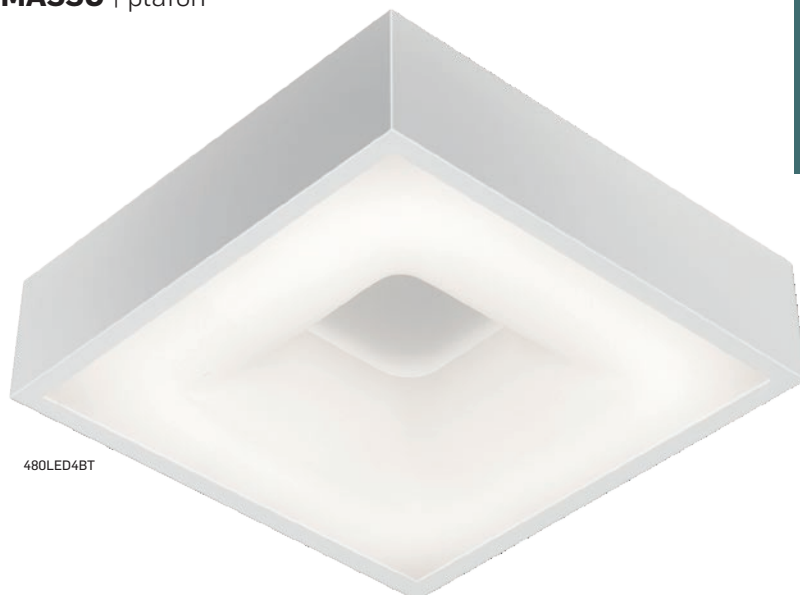

480LED4BT



481LED4PT

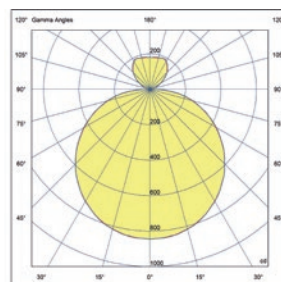
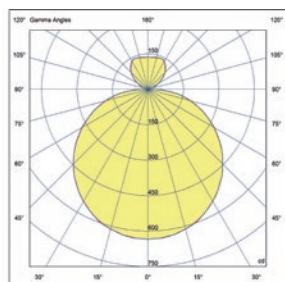
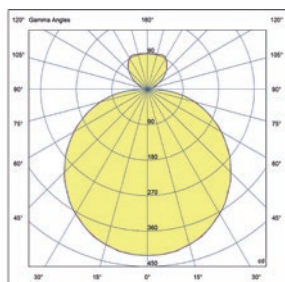

480LED



481LED

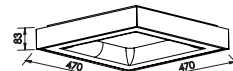

482LED

LedLINE

**3 ANOS DE GARANTIA**  
CONTRA DEFEITOS DE FABRICAÇÃO

PLAFON					
CÓDIGO	POTÊNCIA	FLUXO DA FONTE (lm)	FLUXO DA LUMINÁRIA (lm)	TEMP. COR (K)	DIM. (mm)
480LED3	16,8W	2232	1654	3000 ☉	265 x 265 x 83
480LED4	16,8W	2232	1741	4000 ○	265 x 265 x 83
481LED3	25,2W	3348	2471	3000 ☉	350 x 350 x 83
481LED4	25,2W	3348	2612	4000 ○	350 x 350 x 83
482LED3	33,6W	4464	3308	3000 ☉	470 x 470 x 83
482LED4	33,6W	4464	3482	4000 ○	470 x 470 x 83

### MATERIAL

Produzido em alumínio  
Difusor opalino  
Consulte todos os acabamentos disponíveis

**PRODUTO BIVOLT (127V/220V)**



**NEW MASSU** | pendente



486LED4BT



486LED4PT



**3 ANOS DE GARANTIA**  
CONTRA DEFEITOS DE FABRICAÇÃO

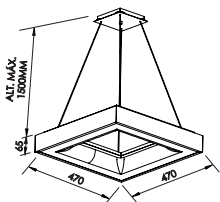
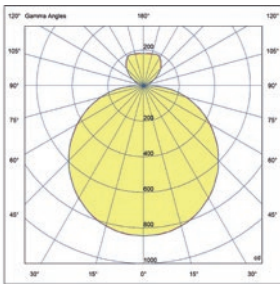

486LED



**MATERIAL**

Produzido em alumínio  
Difusor opalino  
Cabo com ajuste de 1,5m  
Consulte todos os acabamentos disponíveis

**PRODUTO BIVOLT (127V/220V)**

PENDENTE					
CÓDIGO	POTÊNCIA	FLUXO DA FONTE (lm)	FLUXO DA LUMINÁRIA (lm)	TEMP. COR (K)	DIM. (mm)
486LED3	33,6W	4464	3308	3000 ☉	470 x 470 x 70
486LED4	33,6W	4464	3482	4000 ○	470 x 470 x 70



## TRAY LED | plafon



531LED4BT

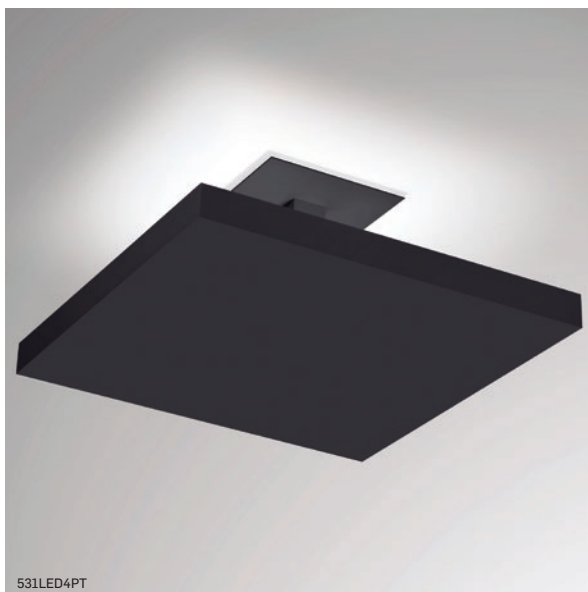

531LED4PT

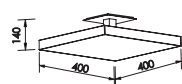

530LED

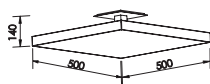

531LED

LedLINE

**3 ANOS DE GARANTIA**  
CONTRA DEFETOS DE FABRICAÇÃO

PLAFON				
CÓDIGO	POTÊNCIA	FLUXO DA FONTE (lm)	TEMP. COR (K)	DIM. (mm)
530LED3	25,2W	2772	3000 ●	400 x 400 x 140
530LED4	25,2W	2772	4000 ○	400 x 400 x 140
531LED3	33,6W	3693	3000 ●	500 x 500 x 140
531LED4	33,6W	3693	4000 ○	500 x 500 x 140

### MATERIAL

Produzido em alumínio  
Consulte todos os acabamentos disponíveis

**PRODUTO BIVOLT (127V/220V)**



## VICTORIA | plafon



160PT



161CE



162BT

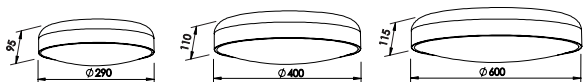

160

161

162

### PLAFON

CÓDIGO	QUANT. LAMP.	LÂMPADA	POT. MÁX.	DIM. (mm)
160	2 x E27	CFL	50W	Ø290 x 95
161	3 x E27	CFL	75W	Ø400 x 110
162	5 x E27	CFL	125W	Ø600 x 115

**3 ANOS DE GARANTIA**  
CONTRA DEFEITOS DE FABRICAÇÃO

### MATERIAL

Produzido em alumínio  
Difusor opalino  
Consulte todos os acabamentos disponíveis

### PRODUTO BIVOLT (127V/220V)

Depende da lâmpada utilizada



## VICTORIA | pendente



165FFCO

167BTCO

166PTCO

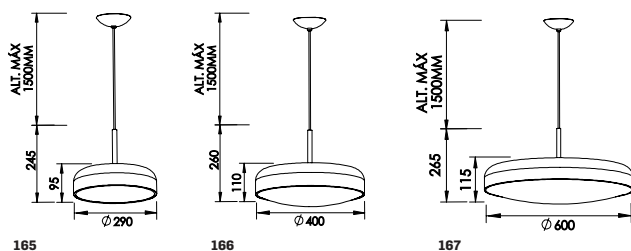

165

166

167

### PENDENTE

CÓDIGO	QUANT. LAMP.	LÂMPADA	POT. MÁX.	DIM. (mm)
165	2 x E27	CFL	50W	Ø290 x 245
166	3 x E27	CFL	75W	Ø400 x 260
167	5 x E27	CFL	125W	Ø600 x 265

**3 ANOS DE GARANTIA**  
CONTRA DEFEITOS DE FABRICAÇÃO

### MATERIAL

Produzido em alumínio  
Difusor opalino  
Cabo revestido em tecido com ajuste de 1,5m  
Consulte todos os acabamentos disponíveis

**PRODUTO BIVOLT (127V/220V)**  
Depende da lâmpada utilizada



## CIRCLE | plafon



SN10151PTCO



SN10152BTDO



SN10152CECO

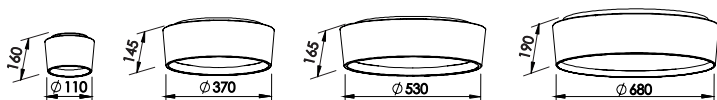

SN10150

SN10151

SN10152

SN10153

**3 ANOS DE GARANTIA**  
CONTRA DEFEITOS DE FABRICAÇÃO

PLAFON				
CÓDIGO	QUANT. LAMP.	LÂMPADA	POT. MÁX.	DIM. (mm)
SN10150	2 x E27	CFL	22W	Ø110 x 160
SN10151	4 x E27	CFL	92W	Ø370 x 145
SN10152	6 x E27	CFL	138W	Ø530 x 165
SN10153	8 x E27	CFL	184W	Ø680 x 190

### MATERIAL

Produzido em alumínio  
Difusor opalino  
Consulte todos os acabamentos disponíveis

### PRODUTO BIVOLT (127V/220V)

Depende da lâmpada utilizada





## CIRCLE | pendente



SN10155BTCO



SN10155PTCO

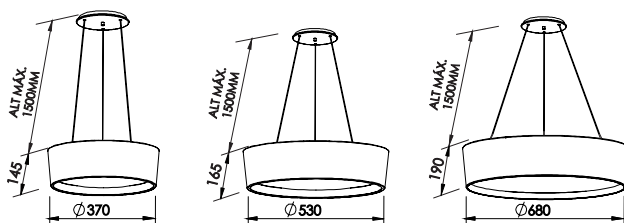

SN10154

SN10155

SN10156

PENDENTE				
CÓDIGO	QUANT. LAMP.	LÂMPADA	POT. MÁX.	DIM. (mm)
SN10154	4 x E27	CFL	92W	Ø370 x 145
SN10155	6 x E27	CFL	138W	Ø530 x 165
SN10156	8 x E27	CFL	184W	Ø680 x 190

**3 ANOS DE GARANTIA**  
CONTRA DEFEITOS DE FABRICAÇÃO

### MATERIAL

Produzido em alumínio  
Difusor opalino  
Cabo ajustável de 1,5m  
Consulte todos os acabamentos disponíveis

### PRODUTO BIVOLT (127V/220V)

Depende da lâmpada utilizada





ST20200PT



ST20201BT



ST20201CE

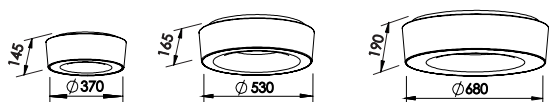

ST20200

ST20201

ST20202

PLAFON				
CÓDIGO	QUANT. LAMP.	LÂMPADA	POT. MÁX.	DIM. (mm)
ST20200	4 x E27	CFL	92W	Ø370 x 145
ST20201	6 x E27	CFL	138W	Ø530 x 165
ST20202	8 x E27	CFL	184W	Ø680 x 190

**3 ANOS DE GARANTIA**  
CONTRA DEFECTOS DE FABRICAÇÃO

### MATERIAL

Produzido em alumínio  
Difusor opalino  
Consulte todos os acabamentos disponíveis

### PRODUTO BIVOLT (127V/220V)

Depende da lâmpada utilizada



## SUSHI | pendente



ST20205PT

ST20205BT

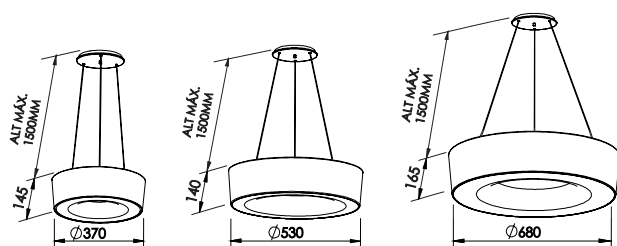

ST20204

ST20205

ST20206

PENDENTE				
CÓDIGO	QUANT. LAMP.	LÂMPADA	POT. MÁX.	DIM. (mm)
ST20204	4 x E27	CFL	92W	Ø370 x 145
ST20205	6 x E27	CFL	138W	Ø530 x 140
ST20206	8 x E27	CFL	184W	Ø680 x 165

**3 ANOS DE GARANTIA**  
CONTRA DEFEITOS DE FABRICAÇÃO

### MATERIAL

Produzido em alumínio  
Difusor opalino  
Cabo ajustável de 1,5m  
Consulte todos os acabamentos disponíveis

**PRODUTO BIVOLT (127V/220V)**  
Depende da lâmpada utilizada



RING | plafon



9045BT



9046PT

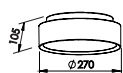

9045

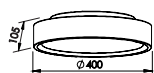

9046



9047

**3 ANOS DE GARANTIA**  
CONTRA DEFETOS DE FABRICAÇÃO

**MATERIAL**

Produzido em alumínio  
Difusor opalino  
Consulte todos os acabamentos disponíveis

**PRODUTO BIVOLT (127V/220V)**

Depende da lâmpada utilizada

PLAFON				
CÓDIGO	QUANT. LAMP.	LÂMPADA	POT. MÁX.	DIM. (mm)
9045	2 x E27	CFL	50W	Ø270 x 105
9046	3 x E27	CFL	75W	Ø400 x 105
9047	6 x E27	CFL	150W	Ø600 x 105



RING | pendente



9085PT



9085BT

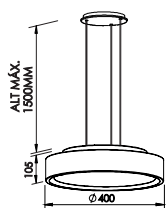

9085

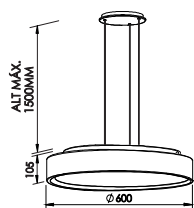

9086

PENDENTE

CÓDIGO	QUANT. LAMP.	LÂMPADA	POT. MÁX.	DIM. (mm)
9085	3 x E27	CFL	75W	Ø400 x 105
9086	6 x E27	CFL	150W	Ø600 x 105

**3 ANOS DE GARANTIA**  
CONTRA DEFETOS DE FABRICAÇÃO

**MATERIAL**

Produzido em alumínio  
Difusor opalino  
Cabo ajustável de 1,5m  
Consulte todos os acabamentos disponíveis

**PRODUTO BIVOLT (127V/220V)**

Depende da lâmpada utilizada





170PT



171BT



172BT



175BT

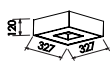

170



171

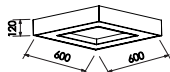

172

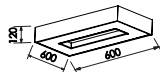

175

**3 ANOS DE GARANTIA**  
CONTRA DEFECTOS DE FABRICAÇÃO

**PLAFON**

CÓDIGO	QUANT. LAMP.	LÂMPADA	POT. MÁX.	DIM. (mm)
170	4 x E27	CFL	100W	327 x 327 x 120
171	4 x E27	CFL	100W	452 x 452 x 120
172	8 x E27	CFL	200W	600 x 600 x 120
175	8 x E27	CFL	200W	720 x 350 x 120

**MATERIAL**

Produzido em alumínio  
Difusor opalino  
Consulte todos os acabamentos disponíveis

**PRODUTO BIVOLT (127V/220V)**

Depende da lâmpada utilizada



**CHESS** | pendente



185BT

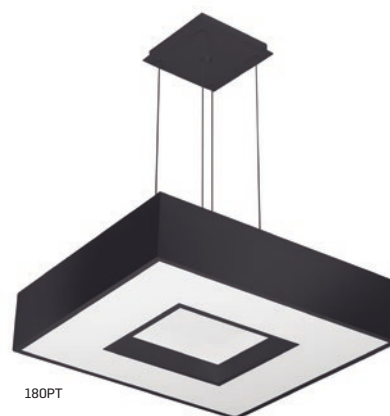

180PT

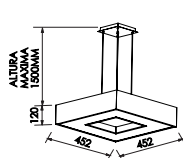

180

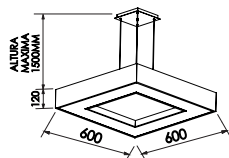

181

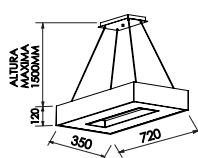

185

PENDENTE				
CÓDIGO	QUANT. LAMP.	LÂMPADA	POT. MÁX.	DIM. (mm)
180	4 x E27	CFL	100W	452 x 452 x 120
181	8 x E27	CFL	200W	600 x 600 x 120
185	8 x E27	CFL	200W	720 x 350 x 120

**3 ANOS DE GARANTIA**  
CONTRA DEFEITOS DE FABRICAÇÃO

**MATERIAL**

Produzido em alumínio  
Difusor opalino  
Cabo ajustável de 1,5m  
Consulte todos os acabamentos disponíveis

**PRODUTO BIVOLT (127V/220V)**  
Depende da lâmpada utilizada





11790BT



11789PT

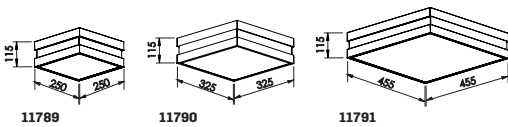

11789

11790

11791

PLAFON				
CÓDIGO	QUANT. LAMP.	LÂMPADA	POT. MÁX.	DIM. (mm)
11789	2 x E27	CFL	30W	250 x 250 x 115
11790	4 x E27	CFL	100W	325 x 325 x 115
11791	6 x E27	CFL	150W	455 x 455 x 115

**3 ANOS DE GARANTIA**  
CONTRA DEFEITOS DE FABRICAÇÃO

#### MATERIAL

Produzido em alumínio  
Difusor opalino  
Consulte todos os acabamentos disponíveis

#### PRODUTO BIVOLT (127V/220V)

Depende da lâmpada utilizada





**WOOD** | pendente



SN10181PTCO



SN10180FDBR



SN10180NDBR



SN10180PTCO



**Detalhe em madeira**  
Sofisticação e design exclusivo da linha Wood



**3 ANOS DE GARANTIA**  
CONTRA DEFEITOS DE FABRICAÇÃO

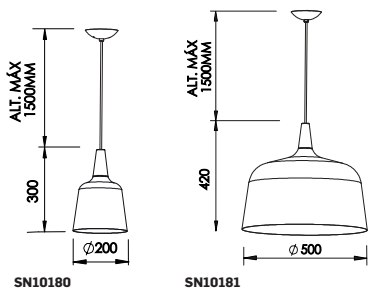

PENDENTE				
CÓDIGO	QUANT. LAMP.	LÂMPADA	POT. MÁX.	DIM. (mm)
SN10180	1 x E27	CFL	23W	Ø200 x 300
SN10181	3 x E27	CFL	75W	Ø500 x 420

**MATERIAL**

Produzido em alumínio  
Detalhe em madeira  
Cabo revestido em tecido com ajuste de 1,5m  
Difusor opalino na SN10181  
Consulte todos os acabamentos disponíveis

**PRODUTO BIVOLT (127V/220V)**  
Depende da lâmpada utilizada



## BILBOQUÊ | pendente



111BTBTCO



111FFFPT



111000PT

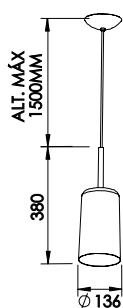

109

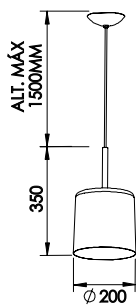

111

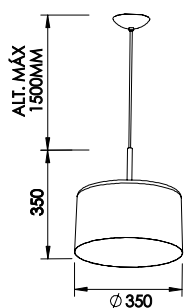

112

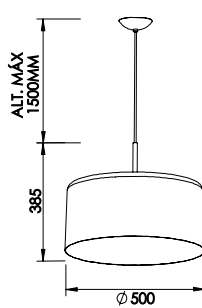

113

### PENDENTE

CÓDIGO	QUANT. LAMP.	LÂMPADA	POT. MÁX.	DIM. (mm)
109	1 x E27	CFL	25W	Ø136 x 380
111	1 x E27	CFL	25W	Ø200 x 350
112	1 x E27	CFL	25W	Ø350 x 350
113	1 x E27	CFL	25W	Ø500 x 385

**3 ANOS DE GARANTIA**  
CONTRA DEFETOS DE FABRICAÇÃO

### MATERIAL

Produzido em alumínio  
Cabo revestido em tecido com ajuste de 1,5m  
Consulte todos os acabamentos disponíveis

### PRODUTO BIVOLT (127V/220V)

Depende da lâmpada utilizada





109PTCOCO



111PTCOCO



112PTCOCO



113PTCOCO



## BAMBOLA | pendente



150FFFPT

150PTCOCO

150BTCOCO



151FFFPT

151PTCOCO

151BTDODO



152FFFPT

152PTCOCO

152BTCOCO



153FFFPT

153PTCOCO

153BTBTCO

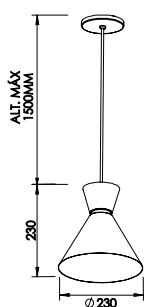

150

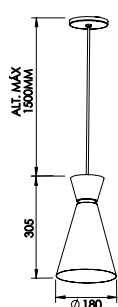

151

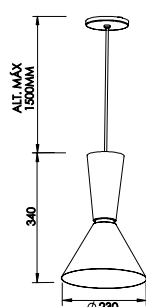

152

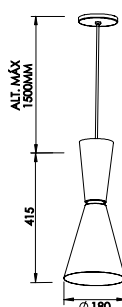

153

### PENDENTE

CÓDIGO	QUANT. LAMP.	LÂMPADA	POT. MÁX.	DIM. (mm)
150	1 x E27	CFL	25W	Ø230 x 230
151	1 x E27	CFL	25W	Ø180 x 305
152	1 x E27	CFL	25W	Ø230 x 340
153	1 x E27	CFL	25W	Ø180 x 415

**3 ANOS DE GARANTIA**  
CONTRA DEFETOS DE FABRICAÇÃO

### MATERIAL

Produzido em alumínio  
Cabo revestido em tecido com ajuste de 1,5m  
Consulte todos os acabamentos disponíveis

### PRODUTO BIVOLT (127V/220V)

Depende da lâmpada utilizada





## NEW INDUSTRIAL | pendente



SNT366PTCOCO

SNT366PTBRPT

SNT366BTBTBT

SNT366PTCOPT



SNT367PTDODO

SNT367PTDOPT

SNT367BTBTBT

SNT367PTCOCO

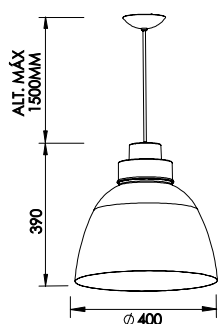

SNT366

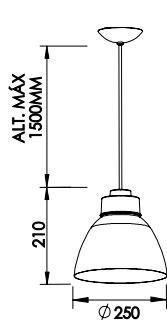

SNT367

### PENDENTE

CÓDIGO	QUANT. LAMP.	LÂMPADA	POT. MÁX.	DIM. (mm)
SNT366	1 x E27	CFL	25W	Ø400 x 390
SNT367	1 x E27	CFL	25W	Ø250 x 210

**3 ANOS DE GARANTIA**  
CONTRA DEFECTOS DE FABRICAÇÃO

### MATERIAL

Produzido em alumínio  
Cabo revestido em tecido com ajuste de 1,5m  
Consulte todos os acabamentos disponíveis

**PRODUTO BIVOLT (127V/220V)**  
Depende da lâmpada utilizada





**NEW ROUND** | pendente



SNT346CE



SNT346BT



Difusor com curvatura especialmente desenvolvida para oferecer o efeito de infinite diffuse. Lâmpadas e difusor praticamente invisíveis quando o produto está aceso.

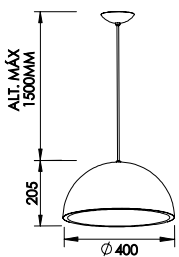

SNT345

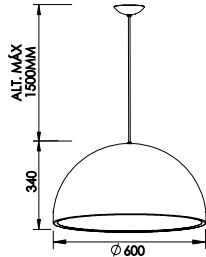

SNT346

**PENDENTE**

CÓDIGO	QUANT. LAMP.	LÂMPADA	POT. MÁX.	DIM. (mm)
SNT345	1 x E27	CFL	25W	Ø400 x 205
SNT346	2 x E27	CFL	50W	Ø600 x 340

**3 ANOS DE GARANTIA**  
CONTRA DEFETOS DE FABRICAÇÃO

**MATERIAL**

Produzido em alumínio  
Difusor opalino  
Cabo revestido em tecido com ajuste de 1,5m  
Consulte todos os acabamentos disponíveis

**PRODUTO BIVOLT (127V/220V)**  
Depende da lâmpada utilizada





**NAVAL** | pendente



552BTCO



552MCCO

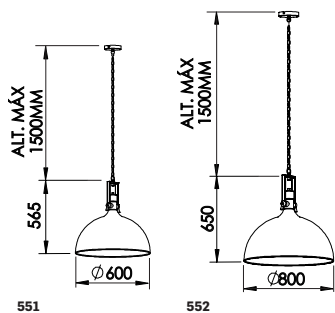

**PENDENTE**

CÓDIGO	QUANT. LAMP.	LÂMPADA	POT. MÁX.	DIM. (mm)
551	1 x E27	CFL	25W	Ø600 x 565
552	1 x E27	CFL	25W	Ø800 x 650

**3 ANOS DE GARANTIA**  
CONTRA DEFETOS DE FABRICAÇÃO

**MATERIAL**

Produzido em alumínio e metal  
Alça e corrente disponíveis somente no acabamento cobre  
Corrente e cabo com ajuste de 1,5m  
Consulte todos os acabamentos disponíveis

**PRODUTO BIVOLT (127V/220V)**

Depende da lâmpada utilizada



## LISSE | pendente



Detalhe da canopla

Ideal para  
uso em forros de  
**GESSO**



Canopla compacta  
especialmente  
desenvolvida para  
montagem de  
composições

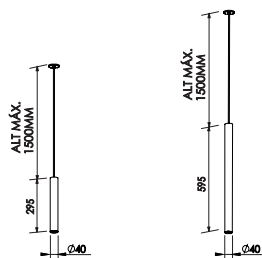

421

426

**3 ANOS DE GARANTIA**  
CONTRA DEFETOS DE FABRICAÇÃO

### MATERIAL

Produzido em alumínio  
Cabo revestido em tecido com ajuste de 1,5m  
Consulte todos os acabamentos disponíveis

### PRODUTO BIVOLT (127V/220V)

Depende da lâmpada utilizada

PENDENTE				
CÓDIGO	QUANT. LAMP.	LÂMPADA	POT. MÁX.	DIM. (mm)
421	1 x GU10/GZ10	MINI DIC.LED	50W	Ø40 x 40 x 295
426	1 x GU10/GZ10	MINI DIC.LED	50W	Ø40 x 40 x 595





## LISSE I / LISSE II | pendente



Detalhe da canopla

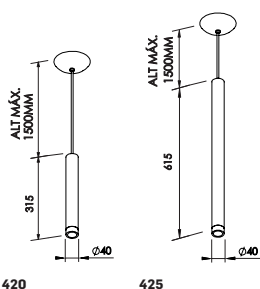

420

425



### PENDENTE

CÓDIGO	QUANT. LAMP.	LÂMPADA	POT. MÁX.	DIM. (mm)
420	1 x GU10/GZ10	MINI DIC.LED	50W	Ø40 x 315
425	1 x GU10/GZ10	MINI DIC.LED	50W	Ø40 x 615

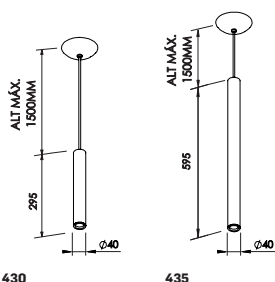

430

435

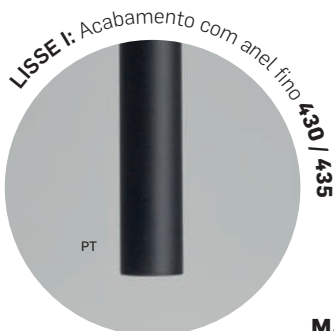

### PENDENTE

CÓDIGO	QUANT. LAMP.	LÂMPADA	POT. MÁX.	DIM. (mm)
430	1 x GU10/GZ10	MINI DIC.LED	50W	Ø40 x 295
435	1 x GU10/GZ10	MINI DIC.LED	50W	Ø40 x 595

**3 ANOS DE GARANTIA**  
CONTRA DEFEITOS DE FABRICAÇÃO

### MATERIAL

Produzido em alumínio  
Cabo revestido em tecido com ajuste de 1,5m  
Consulte todos os acabamentos disponíveis

### PRODUTO BIVOLT (127V/220V)

Depende da lâmpada utilizada



## LISSE I | pendente



IN50800PT  
IN50800BT  
IN50800CO  
IN50800DO



Detalhe da canopla

Para uso  
com lâmpadas  
**PAR16**

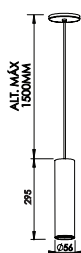

IN50800

### PENDENTE

CÓDIGO	QUANT. LAMP.	LÂMPADA	POT. MÁX.	DIM. (mm)
IN50800	1 x GU10/GZ10	PAR16	50W	Ø56 x 295

**3 ANOS DE GARANTIA**  
CONTRA DEFECTOS DE FABRICAÇÃO

### MATERIAL

Produzido em alumínio  
Cabo revestido em tecido com ajuste de 1,5m  
Consulte todos os acabamentos disponíveis

**PRODUTO BIVOLT (127V/220V)**  
Depende da lâmpada utilizada





341LEDBT



340LEDBT

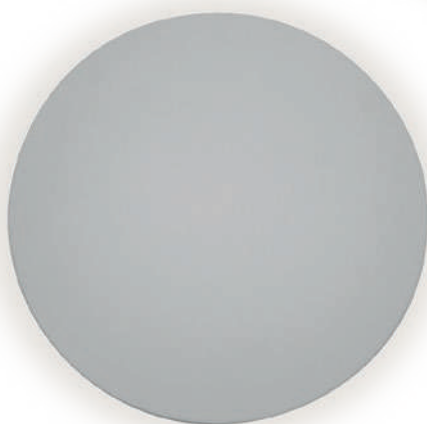

342LEDBT



IN40020BT

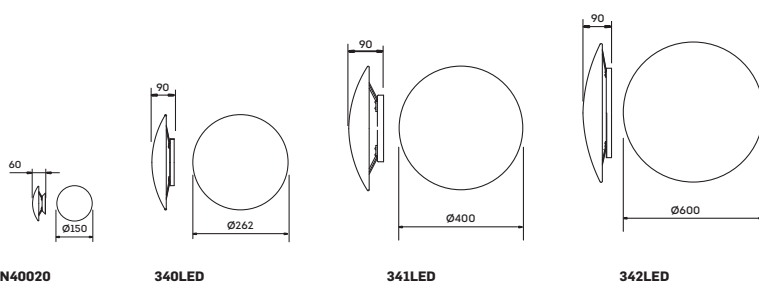

LedLINE

**3 ANOS DE GARANTIA**  
CONTRA DEFETOS DE FABRICAÇÃO

ARANDELA					
CÓDIGO	POTÊNCIA	FLUXO DA FONTE (lm)	TEMP. COR (K)	DIM. (mm)	TENSÃO DE REDE
IN40020	6W	400	2700	Ø150 x 60	127V
IN40021	6W	400	2700	Ø150 x 60	220V
340LED1	6W	400	2700	Ø262 x 90	127V
340LED2	6W	400	2700	Ø262 x 90	220V
341LED1	12W	800	2700	Ø400 x 90	127V
341LED2	12W	800	2700	Ø400 x 90	220V
342LED1	18W	1200	2700	Ø600 x 90	127V
342LED2	18W	1200	2700	Ø600 x 90	220V

### MATERIAL

Produzido em alumínio  
Consulte todos os acabamentos disponíveis







451LED1PTBT

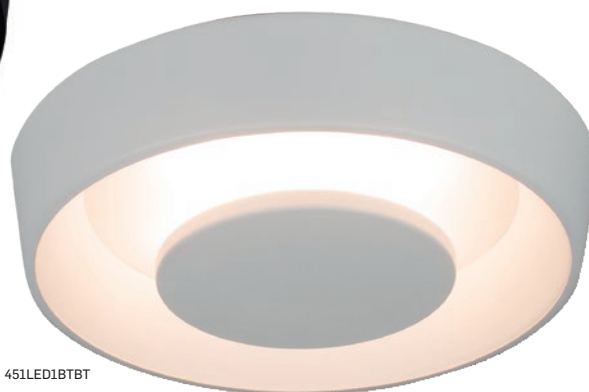

451LED1BTBT

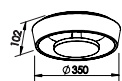
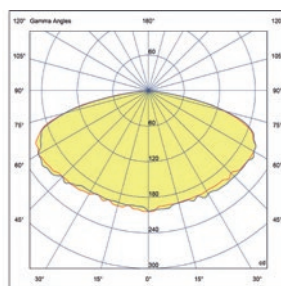
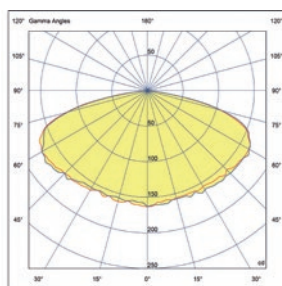
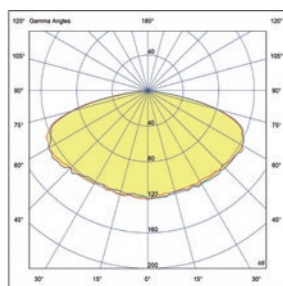

450LED

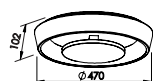

451LED

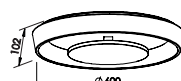

452LED

LedLINE  
**3 ANOS DE GARANTIA**  
 CONTRA DEFETOS DE FABRICAÇÃO

**PLAFON**

CÓDIGO	POTÊNCIA	FLUXO DA FONTE (lm)	FLUXO DA LUMINÁRIA (lm)	TEMP. COR (K)	DIM. (mm)	TENSÃO DE REDE
450LED1	18W	1200	604	2700 ☉	Ø350 x 102	127V
450LED2	18W	1200	604	2700 ☉	Ø350 x 102	220V
451LED1	24W	1600	805	2700 ☉	Ø470 x 102	127V
451LED2	24W	1600	805	2700 ☉	Ø470 x 102	220V
452LED1	30W	2000	1006	2700 ☉	Ø600 x 102	127V
452LED2	30W	2000	1006	2700 ☉	Ø600 x 102	220V

**MATERIAL**

Produzido em alumínio  
 Consulte todos os acabamentos disponíveis





IRIS | embutido

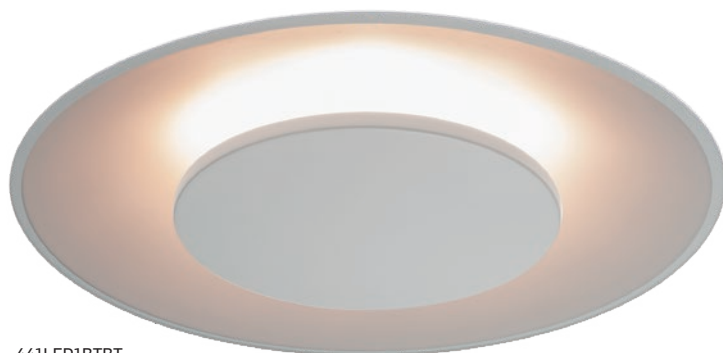

441LED1BTBT

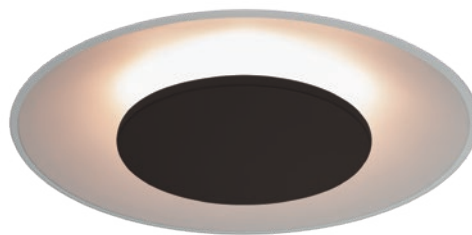

441LED1PTBT

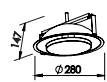

440LED

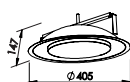

441LED

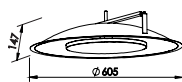

442LED

LedLINE

**3 ANOS DE GARANTIA**  
CONTRA DEFETOS DE FABRICAÇÃO

EMBUTIDO						
CÓDIGO	POTÊNCIA	FLUXO DA FONTE (lm)	TEMP. COR (K)	DIM. (mm)	NICHO (mm)	TENSÃO DE REDE
440LED1	18W	1200	2700 ☉	Ø280 x 147	Ø260	127V
440LED2	18W	1200	2700 ☉	Ø280 x 147	Ø260	220V
441LED1	24W	1600	2700 ☉	Ø405 x 147	Ø380	127V
441LED2	24W	1600	2700 ☉	Ø405 x 147	Ø380	220V
442LED1	30W	2000	2700 ☉	Ø605 x 147	Ø580	127V
442LED2	30W	2000	2700 ☉	Ø605 x 147	Ø580	220V

**MATERIAL**

Produzido em alumínio  
Consulte todos os acabamentos disponíveis



## NEW PICTURE | plafon

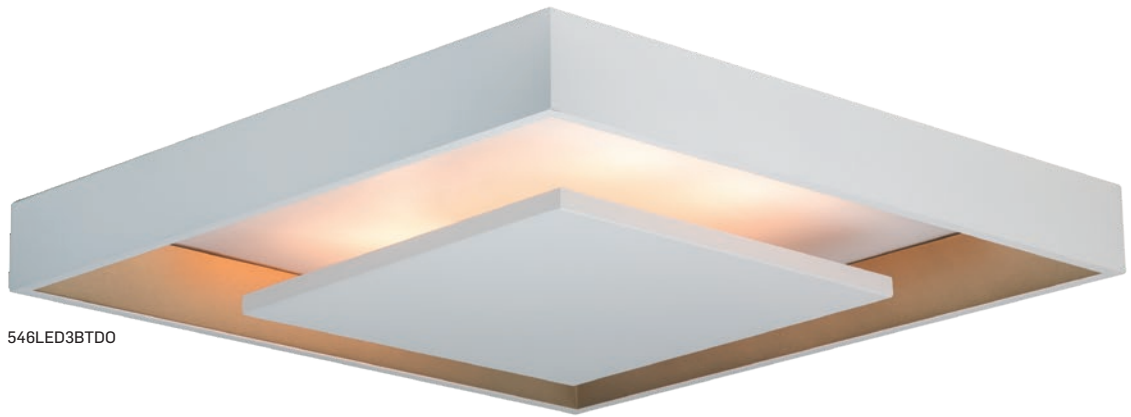

546LED3BTDO

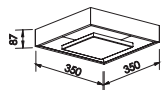
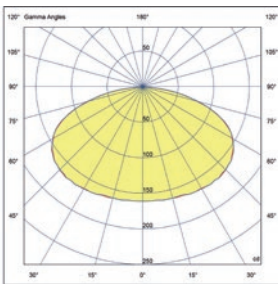

545LED

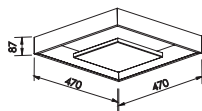
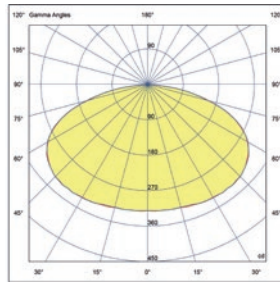

546LED

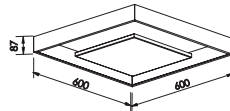
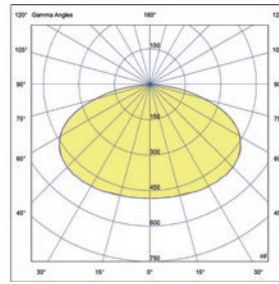

547LED

LedLINE

**3 ANOS DE GARANTIA**  
CONTRA DEFEITOS DE FABRICAÇÃO

### PLAFON

CÓDIGO	POTÊNCIA	FLUXO DA FONTE (lm)	FLUXO DA LUMINÁRIA (lm)	TEMP. COR (K)	DIM. (mm)
545LED3	8,4W	1116	775	3000 ☉	350 x 350 x 87
545LED4	8,4W	1116	816	4000 ○	350 x 350 x 87
546LED3	16,8W	2232	1551	3000 ☉	470 x 470 x 87
546LED4	16,8W	2232	1632	4000 ○	470 x 470 x 87
547LED3	25,2W	3348	2326	3000 ☉	600 x 600 x 87
547LED4	25,2W	3348	2449	4000 ○	600 x 600 x 87

### MATERIAL

Produzido em alumínio  
Consulte todos os acabamentos disponíveis

**PRODUTO BIVOLT (127V/220V)**



## NEW PICTURE | embutido

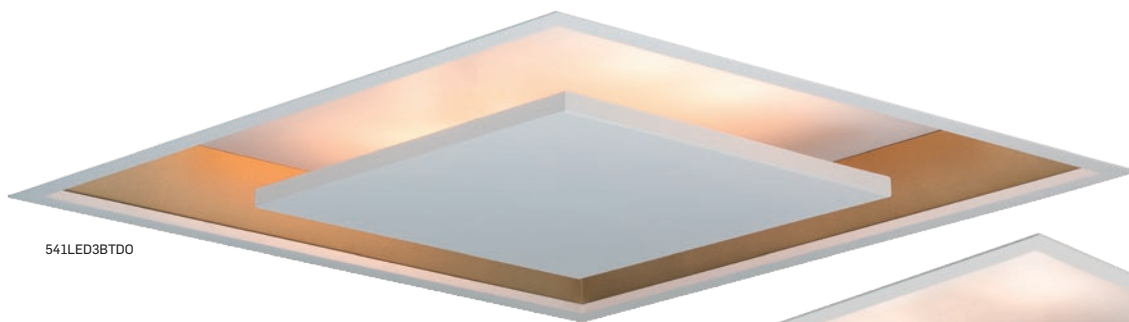

541LED3BTDO



540LED3BTBT

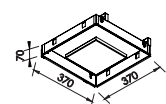
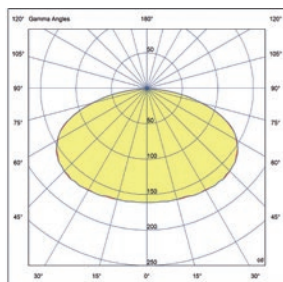

540LED

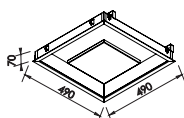
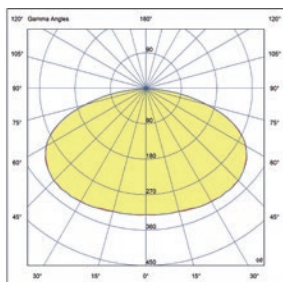

541LED

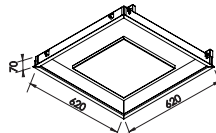
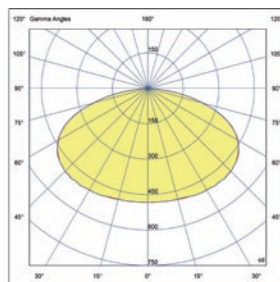

542LED

LedLINE

**3 ANOS DE GARANTIA**  
CONTRA DEFETOS DE FABRICAÇÃO

### EMBUTIDO

CÓDIGO	POTÊNCIA	FLUXO DA FONTE (lm)	FLUXO DA LUMINÁRIA (lm)	TEMP. COR (K)	DIM. (mm)	NICHO (mm)
540LED3	8,4W	1116	775	3000 ☉	370 x 370 x 70	355 x 355
540LED4	8,4W	1116	816	4000 ○	370 x 370 x 70	355 x 355
541LED3	16,8W	2232	1551	3000 ☉	490 x 490 x 70	475 x 475
541LED4	16,8W	2232	1632	4000 ○	490 x 490 x 70	475 x 475
542LED3	25,2W	3348	2326	3000 ☉	620 x 620 x 70	605 x 605
542LED4	25,2W	3348	2449	4000 ○	620 x 620 x 70	605 x 605

### MATERIAL

Produzido em alumínio  
Consulte todos os acabamentos disponíveis

**PRODUTO BIVOLT (127V/220V)**



# PLAFON FOCO | track de sobrepor



Elemento antifusante sempre na cor preta

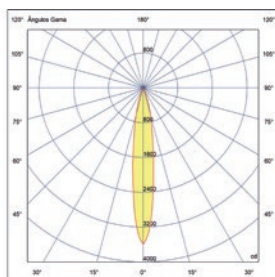
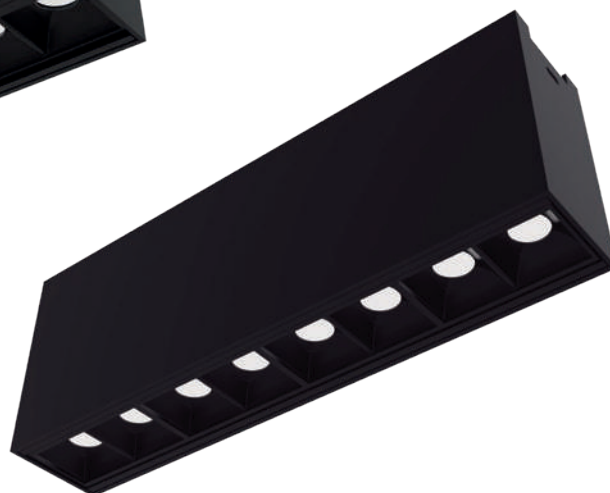

PL0381LED

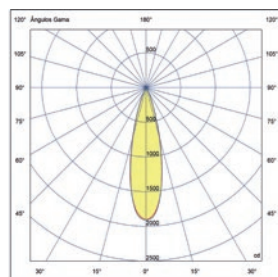

PL0383LED

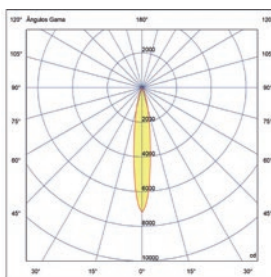

PL0450LED

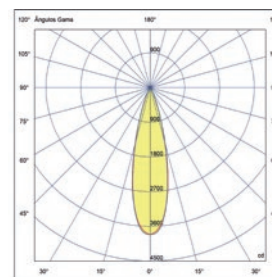
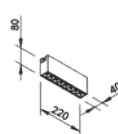

PL0455LED

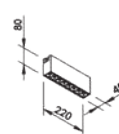

PLAFON FOCO						
CÓDIGO	POTÊNCIA	FLUXO FONTE LUMINOSA (lm)	FLUXO LUMINÁRIA (lm)	TEMP. COR (K)	FOCO	DIM. (mm)
PL0381LED3	4W	600	433	3000	10°	110 x 40 x 80
PL0381LED4	4W	600	456	4000	10°	110 x 40 x 80
PL0383LED3	4W	600	436	3000	24°	110 x 40 x 80
PL0383LED4	4W	600	460	4000	24°	110 x 40 x 80
PL0450LED3	8W	1200	866	3000	10°	220 x 40 x 80
PL0450LED4	8W	1200	912	4000	10°	220 x 40 x 80
PL0455LED3	8W	1200	872	3000	24°	220 x 40 x 80
PL0455LED4	8W	1200	920	4000	24°	220 x 40 x 80



**3 ANOS DE GARANTIA**  
CONTRA DEFEITOS DE FABRICAÇÃO

## MATERIAL

Produzido em alumínio  
Consulte todos os acabamentos disponíveis

**PRODUTO BIVOLT (127V/220V)**



# PLAFON FOCO DIRECIONÁVEL | track de sobrepor

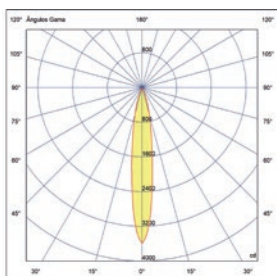

PL0391LED

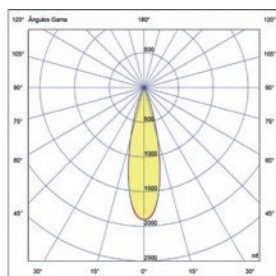
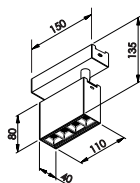

PL0393LED

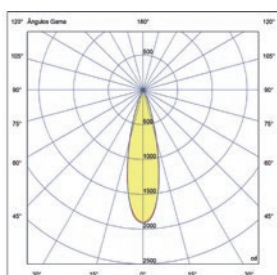
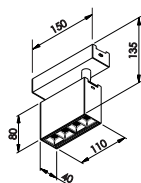

PL0460LED

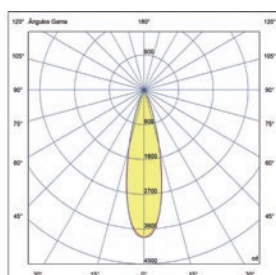
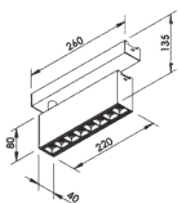

PL0465LED

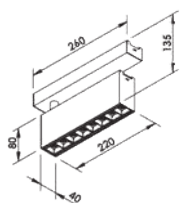

Elemento antiofusco sempre na cor preta

	<b>IRC</b> ≥ 80	<b>127V/220V</b> <b>BI</b> VOLT	TEMP. COR <b>3000k</b> LUZ QUENTE	TEMP. COR <b>4000k</b> LUZ NEUTRA		PRODUCIDO <b>AL</b> EM ALUMÍNIO	PRODUCIDO <b>ABS</b> FOCO				LENTE ANTIOFUSCA	PRETO <b>PT</b> ELETRÓSTATICA	BRANCO <b>BT</b> ELETRÓSTATICA
--	--------------------	---------------------------------------	---	---	--	---------------------------------------	---------------------------------	--	--	--	---------------------	-------------------------------------	--------------------------------------

LedLINE

**3 ANOS DE GARANTIA**  
CONTRA DEFECTOS DE FABRICAÇÃO

PLAFON FOCO DIRECIONÁVEL						
CÓDIGO	POTÊNCIA	FLUXO FONTE LUMINOSA (lm)	FLUXO LUMINÁRIA (lm)	TEMP. COR (K)	FOCO	DIM. (mm)
PL0391LED3	4W	600	433	3000	10°	150 x 40 x 135
PL0391LED4	4W	600	456	4000	10°	150 x 40 x 135
PL0393LED3	4W	600	436	3000	24°	150 x 40 x 135
PL0393LED4	4W	600	460	4000	24°	150 x 40 x 135
PL0460LED3	8W	1200	866	3000	10°	220 x 40 x 135
PL0460LED4	8W	1200	912	4000	10°	220 x 40 x 135
PL0465LED3	8W	1200	872	3000	24°	220 x 40 x 135
PL0465LED4	8W	1200	920	4000	24°	220 x 40 x 135

## MATERIAL

Produzido em alumínio  
Consulte todos os acabamentos disponíveis

**PRODUTO BIVOLT (127V/220V)**





IN41141BT



IN40132BTPT

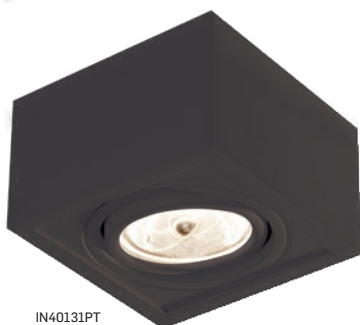

IN40131PT

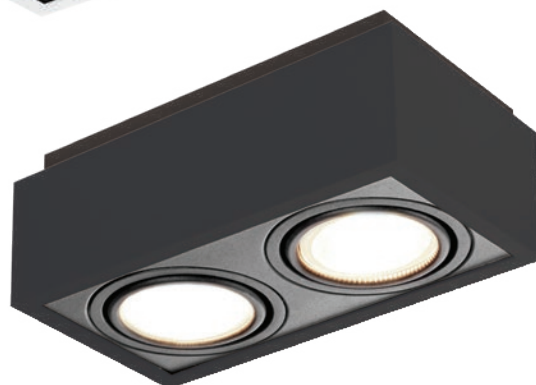

IN40132PTPT

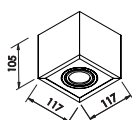

IN40121

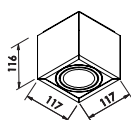

IN40131

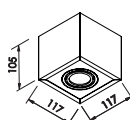

IN41141

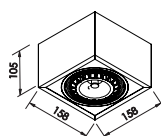

IN41151

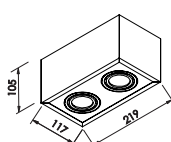

IN40122

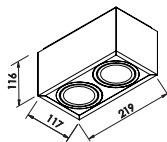

IN40132

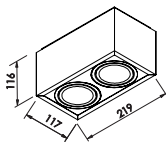

IN41142

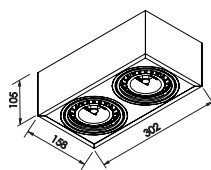

IN41152

**3 ANOS DE GARANTIA**  
CONTRA DEFETOS DE FABRICAÇÃO

PLAFON				
CÓDIGO	QUANT. LAMP.	LÂMPADA	POT. MÁX.	DIM. (mm)
IN40121	1 x GU10/GZ10	PAR16	50W	117 x 117 x 105
IN40122	2 x GU10/GZ10	PAR16	100W	117 x 219 x 105
IN40131	1 x E27	PAR20	50W	116 x 116 x 116
IN40132	2 x E27	PAR20	100W	116 x 219 x 116
IN41141	1 x GU10/GZ10	AR70 LED	50W	116 x 116 x 105
IN41142	2 x GU10/GZ10	AR70 LED	100W	116 x 219 x 105
IN41151	1 x GU10/GZ10	AR111 LED	50W	158 x 158 x 105
IN41152	2 x GU10/GZ10	AR111 LED	100W	158 x 302 x 105

### MATERIAL

Produzido em alumínio  
Consulte todos os acabamentos disponíveis

### PRODUTO BIVOLT (127V/220V)

Depende da lâmpada utilizada







PL03009BTBT



PL03010DODO



PL03011PTPT

**FOCO RECUADO**



**FOCO FACEADO**



Exclusivo sistema de regulagem de altura do foco



PL03010DOPT

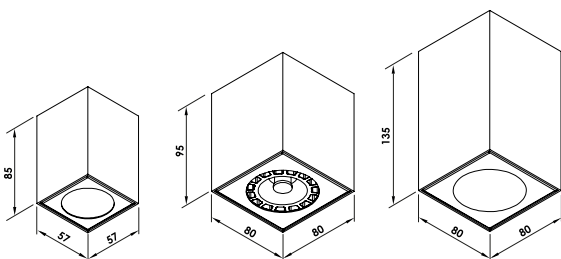

PL03009

PL03010

PL03011

**3 ANOS DE GARANTIA**  
CONTRA DEFEITOS DE FABRICAÇÃO

PLAFON CUBE				
CÓDIGO	QUANT.LÂMP	LÂMPADA	POT. MÁX.	DIM. (mm)
PL03009	1 x GU10/GZ10	PAR16	50	57 x 57 x 85
PL03010	1 x GU10/GZ10	AR70 LED	50	80 x 80 x 95
PL03011	1 x E27	PAR20	50	80 x 80 x 135

**MATERIAL**

Produzido em alumínio  
Consulte todos os acabamentos disponíveis

**PRODUTO BIVOLT (127V/220V)**





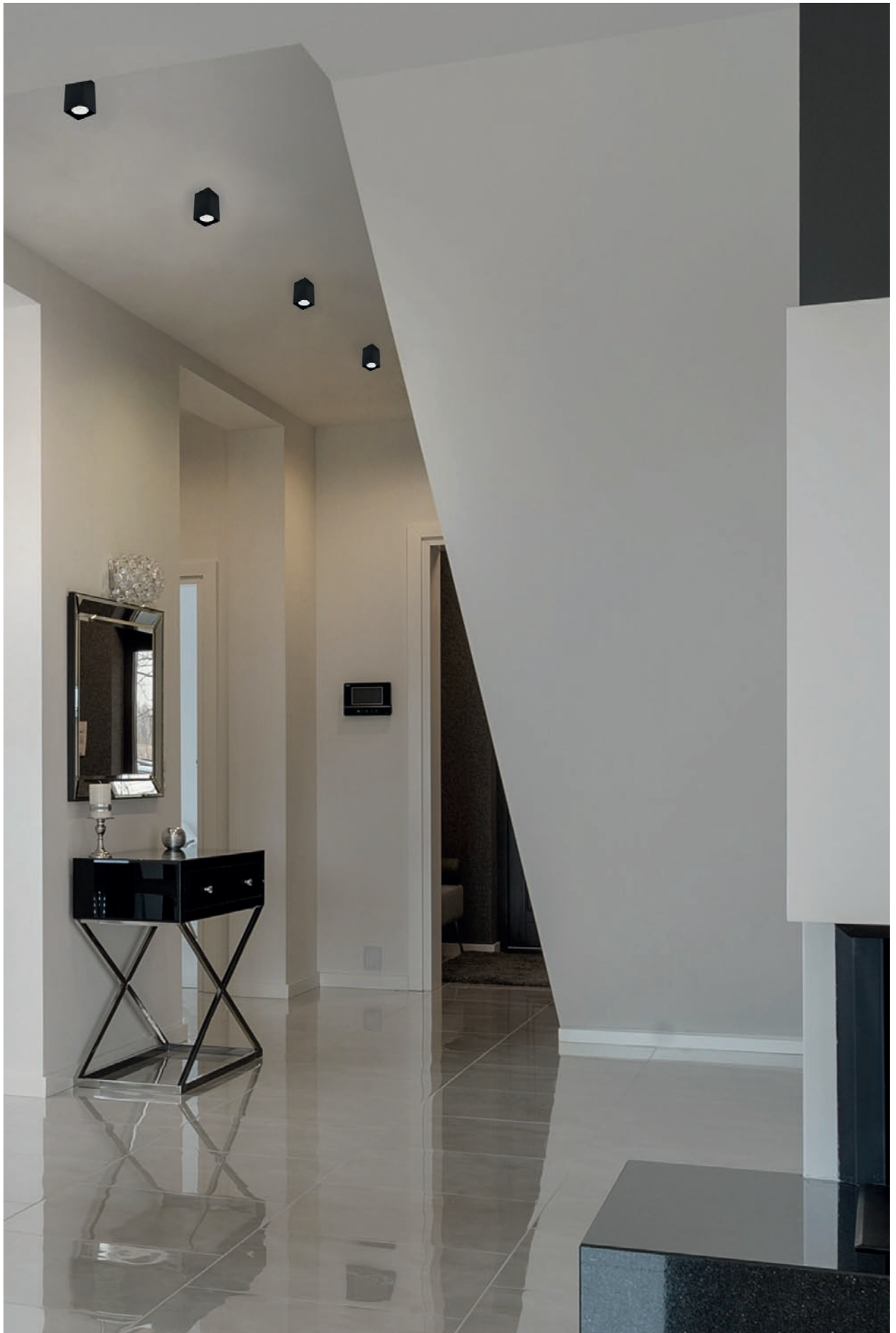

## BOX FOCO | plafon



PL0440LED3BT



PL0441LED3DO



PL0442LED3PT

- Ideal para luz de destaque e montagem de composições
- Disponível nas opções de 3000k e 4000k
- Sistema de regulagem de altura do foco (recuado ou "faceado")
- Lente antiofuscante
- Fácil instalação
- Corpo com diversas opções de acabamento



PLAFON FOCO						
CÓDIGO	POTÊNCIA	FLUXO FONTE LUMINOSA (lm)	FLUXO LUMINÁRIA (lm)	TEMP. COR (K)	FOCO	DIM. (mm)
PL0440LED3	4W	600	433	3000	10°	70 x 70 x 100
PL0440LED4	4W	600	456	4000	10°	70 x 70 x 100
PL0445LED3	4W	600	436	3000	24°	70 x 70 x 100
PL0445LED4	4W	600	460	4000	24°	70 x 70 x 100
PL0441LED3	4W	600	433	3000	10°	70 x 70 x 150
PL0441LED4	4W	600	456	4000	10°	70 x 70 x 150
PL0446LED3	4W	600	436	3000	24°	70 x 70 x 150
PL0446LED4	4W	600	460	4000	24°	70 x 70 x 150
PL0442LED3	4W	600	433	3000	10°	70 x 70 x 200
PL0442LED4	4W	600	456	4000	10°	70 x 70 x 200
PL0447LED3	4W	600	436	3000	24°	70 x 70 x 200
PL0447LED4	4W	600	460	4000	24°	70 x 70 x 200

LedLINE

**3 ANOS DE GARANTIA**  
CONTRA DEFECTOS DE FABRICAÇÃO

### MATERIAL

Produzido em alumínio  
Consulte todos os acabamentos disponíveis

**PRODUTO BIVOLT (127V/220V)**



# BOX FOCO | plafon

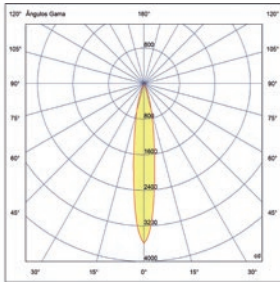

PL0440LED

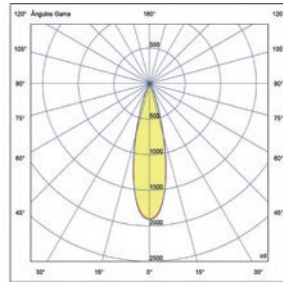
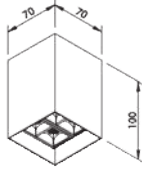

PL0445LED

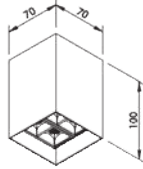

**FOCO RECUADO**



**FOCO FACEADO**



Exclusivo sistema de regulagem de altura do foco

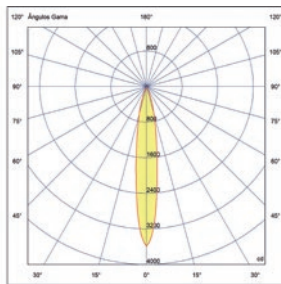

PL0441LED

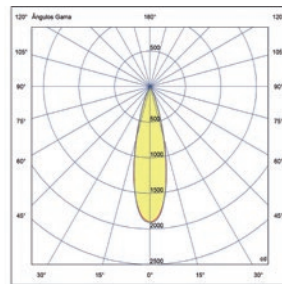
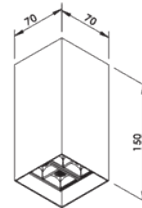

PL0446LED

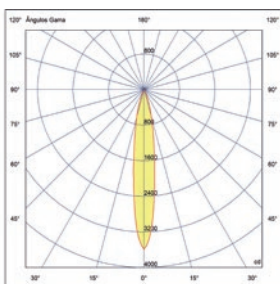
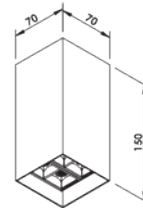

PL0442LED

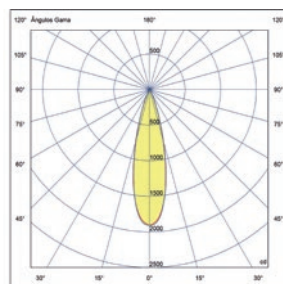
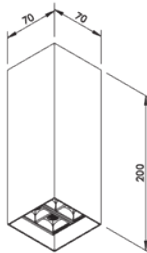

PL0447LED





PL03006DO



IN50525BT



IN50535PT

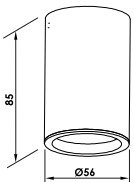

PL03006

Lançamento  
**2021**

**PLAFON**

CÓDIGO	QUANT. LAMP.	LÂMPADA	POT. MÁX.	DIM. (mm)
PL03006	1 x GU10/GZ10	PAR16	50W	Ø56 x 85

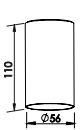

IN50525

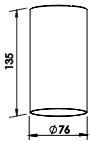

IN50535

**PLAFON**

CÓDIGO	QUANT. LAMP.	LÂMPADA	POT. MÁX.	DIM. (mm)
IN50525	1 x GU10/GZ10	PAR16	50W	Ø56 x 110
IN50535	1 x E27	PAR20	50W	Ø76 x 135



**3 ANOS DE GARANTIA**  
CONTRA DEFETOS DE FABRICAÇÃO

**MATERIAL**

Produzido em alumínio  
Consulte todos os acabamentos disponíveis

**PRODUTO BIVOLT (127V/220V)**  
Depende da lâmpada utilizada





PL03020BT



PL03022BT



PL03022BT

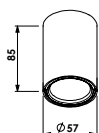

PL03020

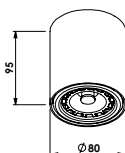

PL03021

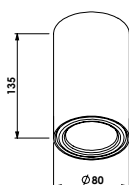

PL03022

PLAFON LISSE II				
CÓDIGO	QUANT. LAMP.	LÂMPADA	POT. MÁX.	DIM. (mm)
PL03020	1 x GU10 GZ10	PAR16	50W	Ø57 x 85
PL03021	1 x GU10 GZ10	AR70 LED	50W	Ø80 x 95
PL03022	1 x E27	PAR20	50W	Ø80 x 135

**3 ANOS DE GARANTIA**  
CONTRA DEFETOS DE FABRICAÇÃO

#### MATERIAL

Produzido em alumínio  
Consulte todos os acabamentos disponíveis

**PRODUTO BIVOLT (127V/220V)**  
Depende da lâmpada utilizada



## FIT 25 | luminária de embutir



760LED3BT

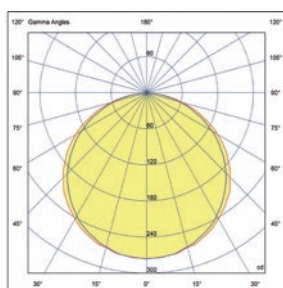

760LED

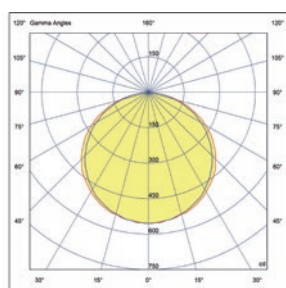
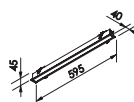

762LED

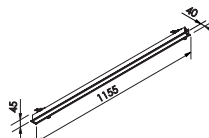

**fit25**  
LINEAR LED LIGHTING

**LedLINE**

**3 ANOS DE GARANTIA**  
CONTRA DEFETOS DE FABRICAÇÃO

### EMBUTIDO

CÓDIGO	POTÊNCIA	FLUXO DA FONTE (lm)	FLUXO DA LUMINÁRIA (lm)	TEMP. COR (K)	DIM. (mm)	NICHO (mm)
760LED3	16W	2200	833	3000 ☉	595 x 40 x 45	585 x 40
760LED4	16W	2200	877	4000 ○	595 x 40 x 45	585 x 40
762LED3	32W	4400	1672	3000 ☉	1155 x 40 x 45	1145 x 40
762LED4	32W	4400	1760	4000 ○	1155 x 40 x 45	1145 x 40

### MATERIAL

Produzido em alumínio  
Difusor acrílico  
Para utilização em forros de Drywall.

**PRODUTO BIVOLT (127V/220V)**



# PLAFON | track de sobrepor

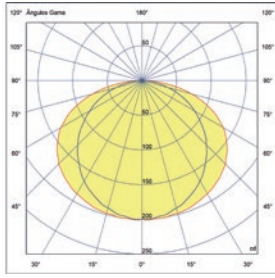

PL0370LED

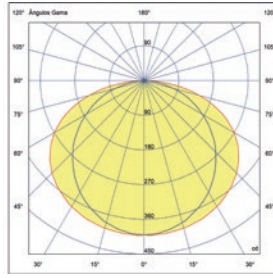
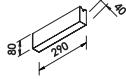

PL0371LED

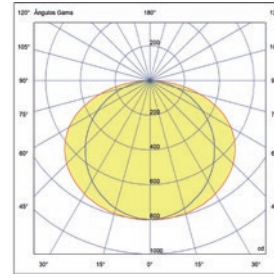
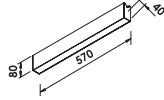

PL0372LED

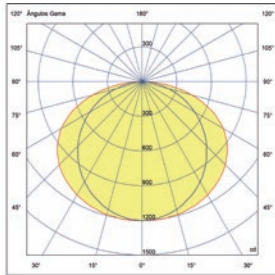
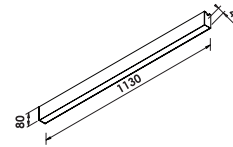

PL0373LED

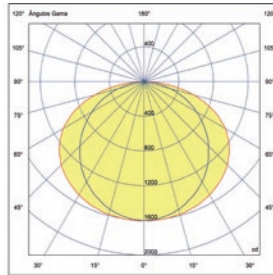
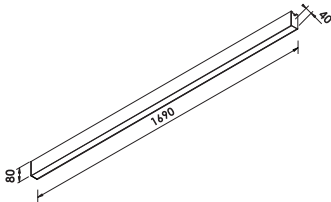

PL0374LED

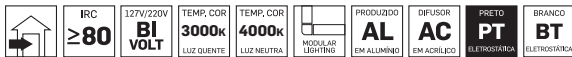
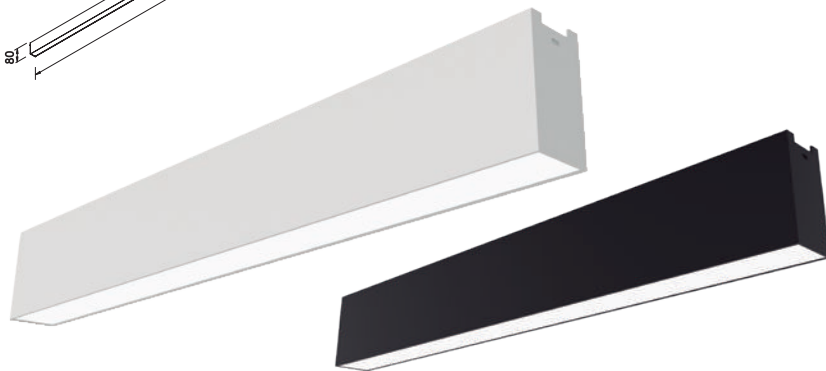
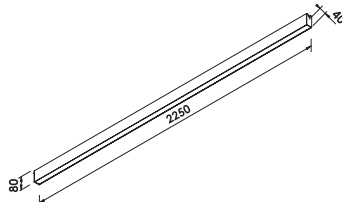

LedLINE

**3 ANOS DE GARANTIA**  
CONTRA DEFEITOS DE FABRICAÇÃO

PLAFON					
CÓDIGO	POTÊNCIA	FLUXO FONTE LUMINOSA (lm)	FLUXO LUMINÁRIA (lm)	TEMP. COR (K)	DIM. (mm)
PL0370LED3	8W	1100	650	3000	290 x 40 x 80
PL0370LED4	8W	1100	673	4000	290 x 40 x 80
PL0371LED3	16W	2200	1300	3000	570 x 40 x 80
PL0371LED4	16W	2200	1347	4000	570 x 40 x 80
PL0372LED3	32W	4400	2600	3000	1130 x 40 x 80
PL0372LED4	32W	4400	2693	4000	1130 x 40 x 80
PL0373LED3	48W	6600	3900	3000	1690 x 40 x 80
PL0373LED4	48W	6600	4040	4000	1690 x 40 x 80
PL0374LED3	64W	8800	5200	3000	2250 x 40 x 80
PL0374LED4	64W	8800	5386	4000	2250 x 40 x 80

## MATERIAL

Produzido em alumínio  
Difusor de acrílico  
Consulte todos os acabamentos disponíveis

**PRODUTO BIVOLT (127V/220V)**



# PENDENTE UP DOWN LIGHT | track aéreo

## Possibilidade de acendimento individual

- Necessário individualização da instalação elétrica.

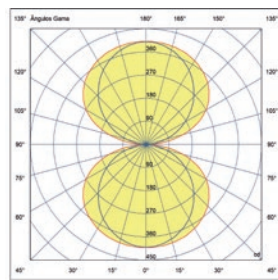

PD0376LED

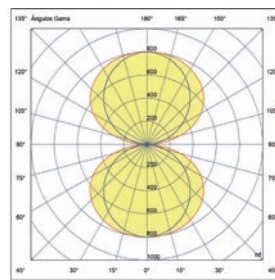
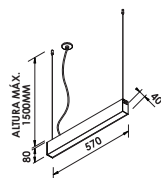

PD0377LED

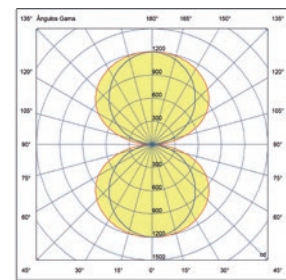
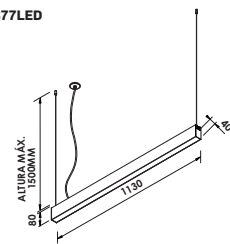

PD0378LED

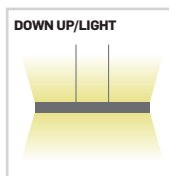
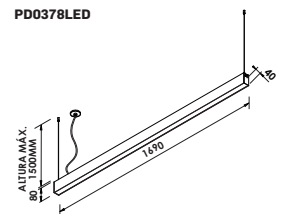

Led LINE

**3 ANOS DE GARANTIA**  
CONTRA DEFEITOS DE FABRICAÇÃO

IRC ≥80	127V/220V BIVOLT	TEMP. COR 3000k	TEMP. COR 4000k	MODULAR LIGHTING	PRODUTOS AL EM ALUMÍNIO	AC EM ACRÍLICO	PRETO PT ELETROFARBA	BRANCO BT ELETROFARBA
---------	------------------	-----------------	-----------------	------------------	-------------------------	----------------	----------------------	-----------------------

## PENDENTE UP/DOWN LIGHT

CÓDIGO	POTÊNCIA	FLUXO FONTE LUMINOSA (lm)	FLUXO LUMINÁRIA (lm)	TEMP. COR (K)	DIM. (mm)
PD0376LED3	32W	4400	2600	3000	570 x 40 x 80
PD0376LED4	32W	4400	2693	4000	570 x 40 x 80
PD0377LED3	64W	8800	5200	3000	1130 x 40 x 80
PD0377LED4	64W	8800	5386	4000	1130 x 40 x 80
PD0378LED3	96W	13200	7800	3000	1690 x 40 x 80
PD0378LED4	96W	13200	8079	4000	1690 x 40 x 80

## MATERIAL

Produzido em alumínio  
Difusor de acrílico  
Consulte todos os acabamentos disponíveis

**PRODUTO BIVOLT (127V/220V)**





# PENDENTE DOWN LIGHT | track aéreo

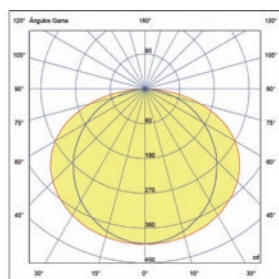
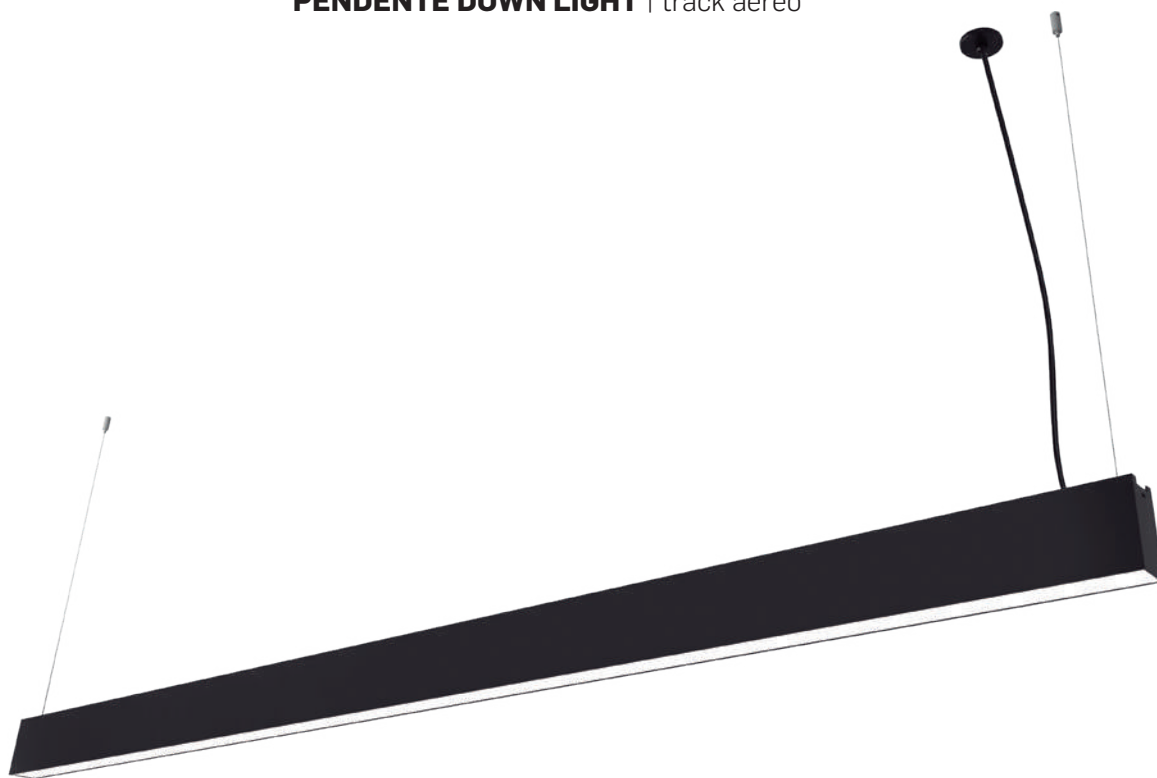

PD0371LED

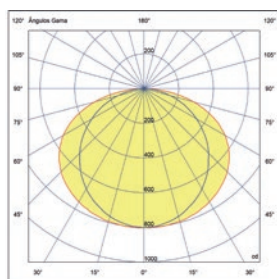
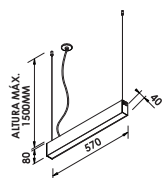

PD0372LED

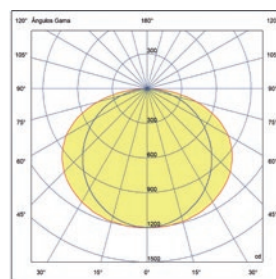
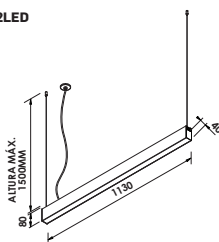

PD0373LED

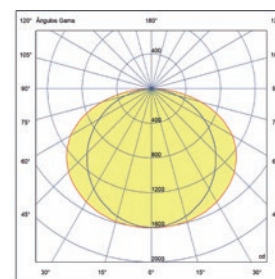
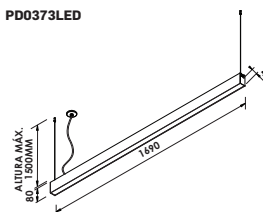

PD0374LED

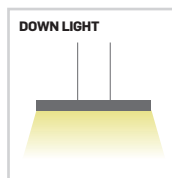
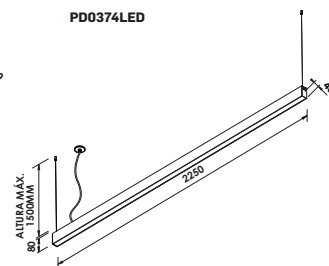

LedLINE

**3 ANOS DE GARANTIA**  
CONTRA DEFETOS DE FABRICAÇÃO

PENDENTE DOWN LIGHT					
CÓDIGO	POTÊNCIA	FLUXO FONTE LUMINOSA (lm)	FLUXO LUMINÁRIA (lm)	TEMP. COR (K)	DIM. (mm)
PD0371LED3	16W	2200	1300	3000	570 x 40 x 80
PD0371LED4	16W	2200	1347	4000	570 x 40 x 80
PD0372LED3	32W	4400	2600	3000	1130 x 40 x 80
PD0372LED4	32W	4400	2693	4000	1130 x 40 x 80
PD0373LED3	48W	6600	3900	3000	1690 x 40 x 80
PD0373LED4	48W	6600	4040	4000	1690 x 40 x 80
PD0374LED3	64W	8800	5200	3000	2250 x 40 x 80
PD0374LED4	64W	8800	5386	4000	2250 x 40 x 80

## MATERIAL

Produzido em alumínio  
Difusor de acrílico  
Consulte todos os acabamentos disponíveis

**PRODUTO BIVOLT (127V/220V)**





IN40326BT



IN40326PT

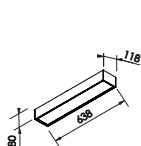

IN40321

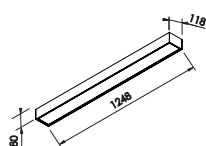

IN40326

**3 ANOS DE GARANTIA**  
CONTRA DEFETOS DE FABRICAÇÃO

**MATERIAL**

Produzido em alumínio  
Difusor opalino  
Consulte todos os acabamentos disponíveis

**PRODUTO BIVOLT (127V/220V)**  
Depende da lâmpada utilizada

PLAFON				
CÓDIGO	QUANT. LAMP.	LÂMPADA	POT. MÁX.	DIM. (mm)
IN40321	2 x G13	T8 LED 60cm	100	638 x 118 x 80
IN40326	2 x G13	T8 LED 120cm	100	1248 x 118 x 80



## SOBREPOR III | plafon



IN40301BT

IN40301PT

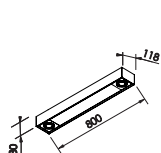

IN40301

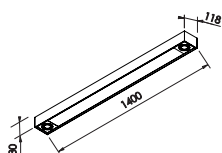

IN40306

**3 ANOS DE GARANTIA**  
CONTRA DEFETOS DE FABRICAÇÃO

PLAFON				
CÓDIGO	QUANT. LAMP.	LÂMPADA	POT. MÁX.	DIM. (mm)
IN40301	2 x G13	T8 LED 60cm	100W	800 x 118 x 80
IN40301	2 x GU10/GZ10	PAR16	100W	800 x 118 x 80
IN40306	2 x G13	T8 LED 120cm	100W	1400 x 118 x 102
IN40306	2 x GU10/GZ10	PAR16 LED	100W	1400 x 118 x 102

### MATERIAL

Produzido em alumínio  
Difusor opalino  
Consulte todos os acabamentos disponíveis

### PRODUTO BIVOLT (127V/220V)

Depende da lâmpada utilizada



## SOBREPOR III | pendente



IN40336BT

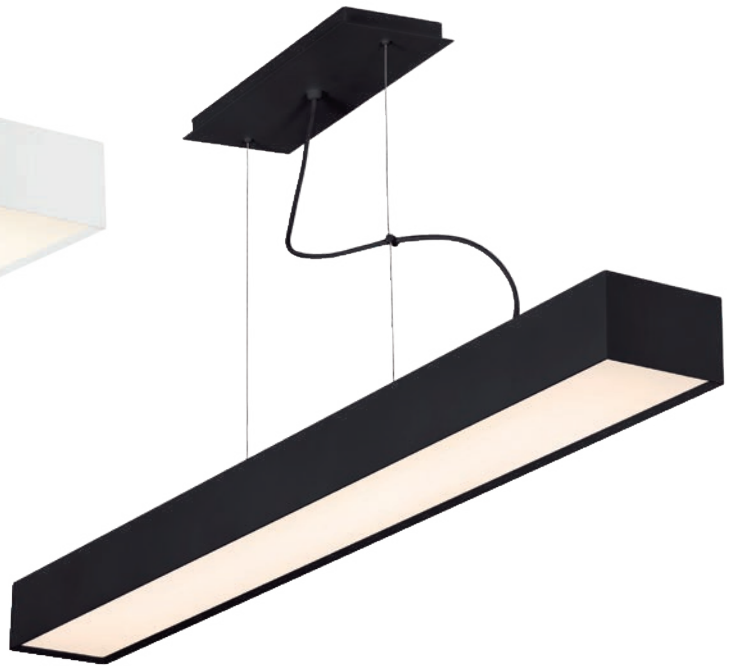

IN40336PT

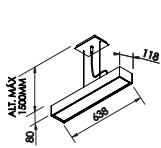

IN40331

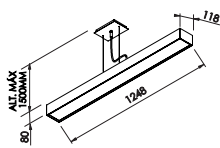

IN40336

LedLINE

**3 ANOS DE GARANTIA**  
CONTRA DEFETOS DE FABRICAÇÃO

### MATERIAL

Produzido em alumínio  
Difusor opalino  
Cabo com ajuste de 1,5m  
Consulte todos os acabamentos disponíveis

### PRODUTO BIVOLT (127V/220V)

Depende da lâmpada utilizada

PENDENTE				
CÓDIGO	QUANT. LAMP.	LÂMPADA	POT. MÁX.	DIM. (mm)
IN40331	2 x G13	T8 LED 60cm	100W	638 x 118 x 80
IN40336	2 x G13	T8 LED 120cm	100W	1248 x 118 x 80



## SOBREPOR III | pendente



IN40316BT

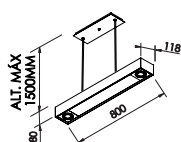

IN40311

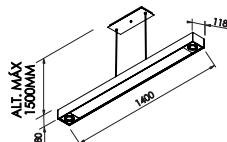

IN40316

Led LINE

**3 ANOS DE GARANTIA**  
CONTRA DEFEITOS DE FABRICAÇÃO

### PENDENTE

CÓDIGO	QUANT. LAMP.	LÂMPADA	POT. MÁX.	DIM. (mm)
IN40311	2 x G13	T8 LED 60cm	100W	800 x 118 x 80
IN40311	2 x GU10/GZ10	PAR16	100W	800 x 118 x 80
IN40316	2 x G13	T8 LED 120cm	100W	1400 x 118 x 80
IN40316	2 x GU10/GZ10	PAR16 LED	100W	1400 x 118 x 80

### MATERIAL

Produzido em alumínio  
Difusor opalino  
Cabo com ajuste de 1,5m  
Consulte todos os acabamentos disponíveis

### PRODUTO BIVOLT (127V/220V)

Depende da lâmpada utilizada



## SLIM II | embutido



593LED3BT



596LED3BT

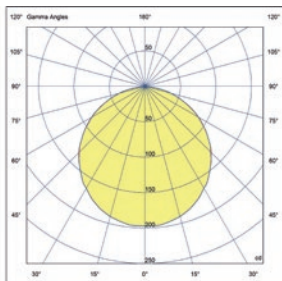

590LED

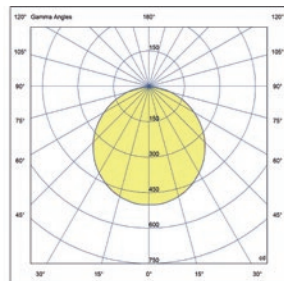

591LED

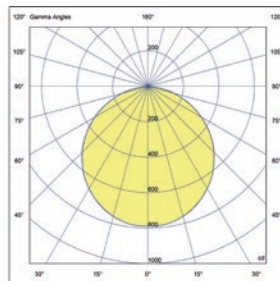
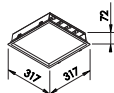

592LED

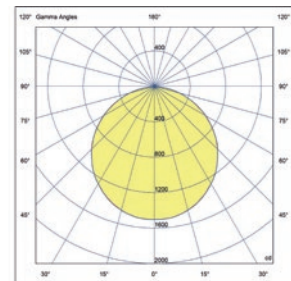
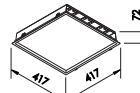

593LED

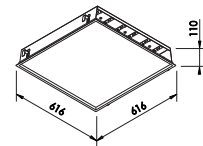

### EMBUTIDO

CÓDIGO	POTÊNCIA	FLUXO DA FONTE (lm)	FLUXO DA LUMINÁRIA (lm)	TEMP. COR (K)	DIM. (mm)	NICHO (mm)
590LED3	12,6W	1380	559	3000 ☉	227 x 227 x 72	210 x 210
590LED4	12,6W	1380	588	4000 ○	227 x 227 x 72	210 x 210
591LED3	32W	4400	1418	3000 ☉	317 x 317 x 72	300 x 300
591LED4	32W	4400	1493	4000 ○	317 x 317 x 72	300 x 300
592LED3	50,4W	5544	2234	3000 ☉	417 x 417 x 72	400 x 400
592LED4	50,4W	5544	2352	4000 ○	417 x 417 x 72	400 x 400
593LED3	96W	13200	4255	3000 ☉	616 x 616 x 110	599 x 599
593LED4	96W	13200	4479	4000 ○	616 x 616 x 110	599 x 599

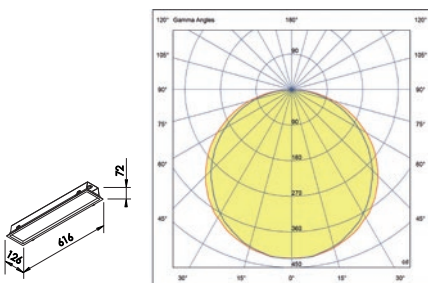

595LED

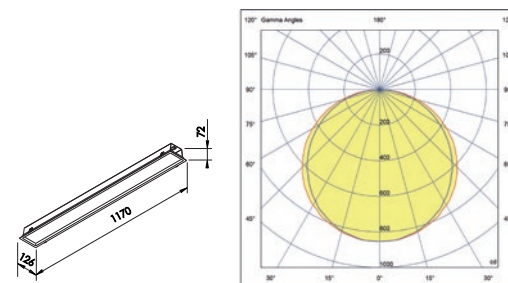
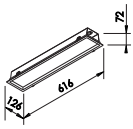

596LED

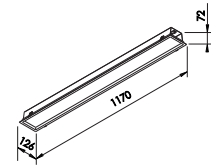

LedLINE

**3 ANOS DE GARANTIA**  
CONTRA DEFEITOS DE FABRICAÇÃO

### EMBUTIDO

CÓDIGO	POTÊNCIA	FLUXO DA FONTE (lm)	FLUXO DA LUMINÁRIA (lm)	TEMP. COR (K)	DIM. (mm)	NICHO (mm)
595LED3	16W	2200	1310	3000 ☉	616 x 126 x 72	509 x 109
595LED4	16W	2200	1379	4000 ○	616 x 126 x 72	509 x 109
596LED3	32W	4400	2620	3000 ☉	1170 x 126 x 72	1153 x 109
596LED4	32W	4400	2758	4000 ○	1170 x 126 x 72	1153 x 109

### MATERIAL

Produzido em alumínio  
Difusor opalino  
Consulte todos os acabamentos disponíveis

**PRODUTO BIVOLT (127V/220V)**



## SLIM II | embutido

IN9012ABT

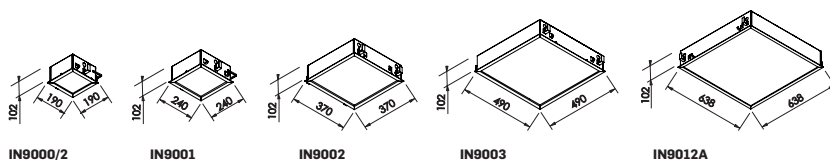

EMBUTIDO					
CÓDIGO	QUANT. LAMP.	LÂMPADA	POT. MÁX.	DIM. (mm)	NICHO
IN9000/2	2 x E27	CFL	50W	190 x 190 x 102	175 x 175
IN9001	2 x E27	CFL	50W	240 x 240 x 102	225 x 225
IN9002	4 x E27	CFL	100W	370 x 370 x 102	355 x 355
IN9003	8 x E27	CFL	200W	490 x 490 x 102	475 x 475
IN9012A	4 x G13	T8	72W	638 x 638 x 102	620 x 620

**3 ANOS DE GARANTIA**  
CONTRA DEFECTOS DE FABRICAÇÃO

### MATERIAL

Produzido em alumínio  
Difusor opalino  
Consulte todos os acabamentos disponíveis

**PRODUTO BIVOLT (127V/220V)**  
Depende da lâmpada utilizada



## SLIM II | embutido



IN9007BT

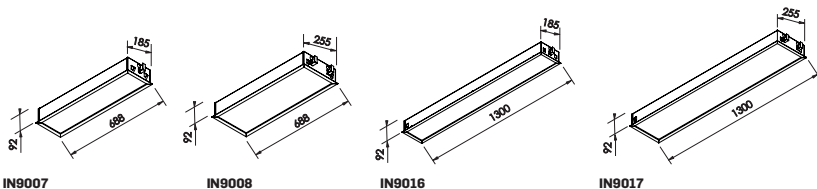

EMBUTIDO					
CÓDIGO	QUANT. LAMP.	LÂMPADA	POT. MÁX.	DIM. (mm)	NICHO
IN9007	2 x G13	T8	36W	688 x 185 x 92	675 x 170
IN9008	4 x G13	T8	72W	688 x 255 x 92	675 x 240
IN9016	2 x G13	T8	72W	1300 x 185 x 92	1285 x 170
IN9017	4 x G13	T8	144W	1300 x 255 x 92	1285 x 240

**3 ANOS DE GARANTIA**  
CONTRA DEFEITOS DE FABRICAÇÃO

### MATERIAL

Produzido em alumínio.  
Difusor opalino  
Consulte todos os acabamentos disponíveis

**PRODUTO BIVOLT (127V/220V)**  
Depende da lâmpada utilizada





## SLIM II | embutido

IN50231BT

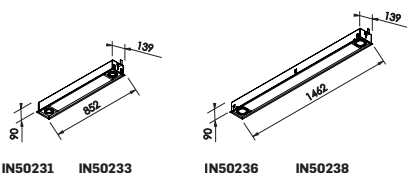

IN50231 IN50233

IN50236 IN50238

**3 ANOS DE GARANTIA**  
CONTRA DEFEITOS DE FABRICAÇÃO

EMBUTIDO					
CÓDIGO	QUANT. LAMP.	LÂMPADA	POT. MÁX.	DIM. (mm)	NICHO
IN50231	2 x G13	T8	36W	139 x 852 x 90	126 x 839
IN50231	2 x GU10/GZ10	PAR16	100W	139 x 852 x 90	126 x 839
IN50233	2 x G13	T8	36W	139 x 852 x 90	126 x 839
IN50233	2 x E27	GU10/GZ10	100W	139 x 852 x 90	126 x 839
IN50236	2 x G13	T8	64W	139 x 1462 x 90	126 x 1449
IN50236	2 x GU10/GZ10	PAR16	100W	139 x 1462 x 90	126 x 1449
IN50238	2 x G13	T8	64W	139 x 1462 x 90	126 x 1449
IN50238	2 x E27	PAR20	100W	139 x 1462 x 90	126 x 1449

### MATERIAL

Produzido em alumínio  
Difusor opalino  
Consulte todos os acabamentos disponíveis

### PRODUTO BIVOLT (127V/220V)

Depende da lâmpada utilizada





603LED3BT



605LED3BT

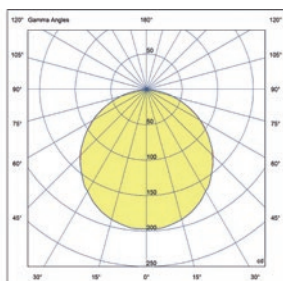

600LED

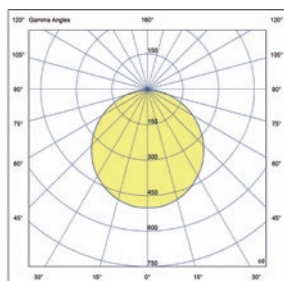

601LED

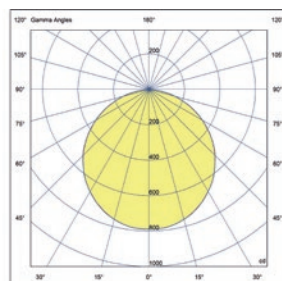
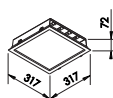

602LED

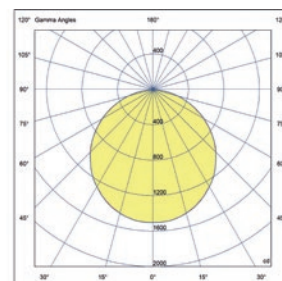
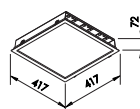

603LED

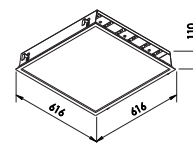

EMBUTIDO						
CÓDIGO	POTÊNCIA	FLUXO DA FONTE (lm)	FLUXO DA LUMINÁRIA (lm)	TEMP. COR (K)	DIM. (mm)	NICHO (mm)
600LED3	12,6W	1380	559	3000 ☉	227 x 227 x 72	210 x 210
600LED4	12,6W	1380	588	4000 ○	227 x 227 x 72	210 x 210
601LED3	32W	4400	1418	3000 ☉	317 x 317 x 72	300 x 300
601LED4	32W	4400	1493	4000 ○	317 x 317 x 72	300 x 300
602LED3	50,4W	5544	2234	3000 ☉	417 x 417 x 72	400 x 400
602LED4	50,4W	5544	2352	4000 ○	417 x 417 x 72	400 x 400
603LED3	96W	13200	4255	3000 ☉	616 x 616 x 110	599 x 599
603LED4	96W	13200	4479	4000 ○	616 x 616 x 110	599 x 599

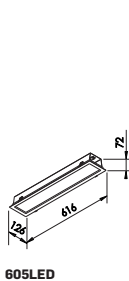

605LED

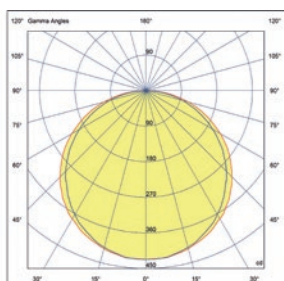

606LED

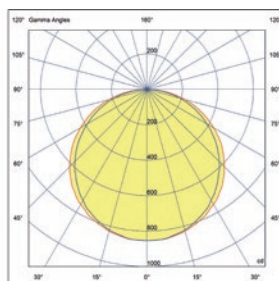
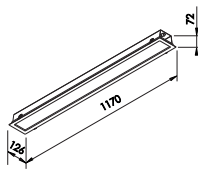

Led LINE

**3 ANOS DE GARANTIA**  
CONTRA DEFEITOS DE FABRICAÇÃO

EMBUTIDO						
CÓDIGO	POTÊNCIA	FLUXO DA FONTE (lm)	FLUXO DA LUMINÁRIA (lm)	TEMP. COR (K)	DIM. (mm)	NICHO (mm)
605LED3	16W	2200	1310	3000 ☉	616 x 126 x 72	599 x 109
605LED4	16W	2200	1379	4000 ○	616 x 126 x 72	599 x 109
606LED3	32W	4400	2620	3000 ☉	1170 x 126 x 72	1153 x 109
606LED4	32W	4400	2758	4000 ○	1170 x 126 x 72	1153 x 109

### MATERIAL

Produzido em alumínio  
Difusor opalino  
Consulte todos os acabamentos disponíveis

**PRODUTO BIVOLT (127V/220V)**





IN8012ABT

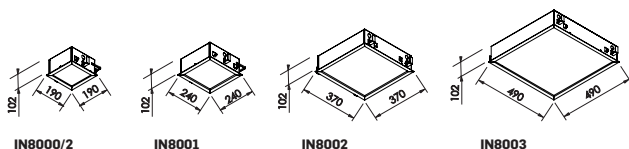
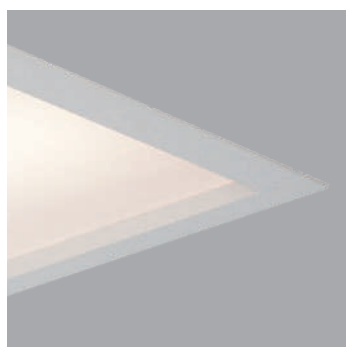

IN8000/2

IN8001

IN8002

IN8003

EMBUTIDO					
CÓDIGO	QUANT. LAMP.	LÂMPADA	POT. MÁX.	DIM. (mm)	NICHO
IN8000/2	2 x E27	CFL	40W	190 x 190 x 102	175 x 175
IN8001	2 x E27	CFL	50W	240 x 240 x 102	225 x 225
IN8002	4 x E27	CFL	100W	370 x 370 x 102	355 x 355
IN8003	8 x E27	CFL	200W	490 x 490 x 102	475 x 475

**3 ANOS DE GARANTIA**  
CONTRA DEFEITOS DE FABRICAÇÃO

### MATERIAL

Produzido em alumínio  
Difusor opalino  
Consulte todos os acabamentos disponíveis

**PRODUTO BIVOLT (127V/220V)**  
Depende da lâmpada utilizada





IN8007BT

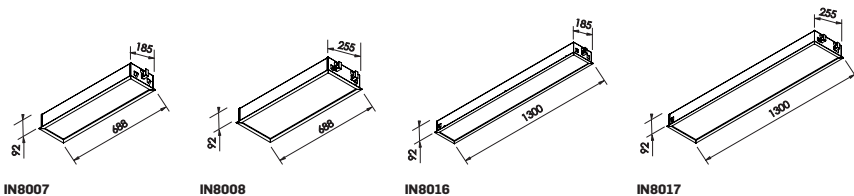

**3 ANOS DE GARANTIA**  
CONTRA DEFEITOS DE FABRICAÇÃO

EMBUTIDO					
CÓDIGO	QUANT. LAMP.	LÂMPADA	POT. MÁX.	DIM. (mm)	NICHO
IN8007	2 x G13	T8	36W	688 x 185 x 92	675 x 170
IN8008	4 x G13	T8	72W	688 x 255 x 92	675 x 240
IN8016	2 x G13	T8	72W	1300 x 185 x 92	1285 x 170
IN8017	4 x G13	T8	144W	1300 x 255 x 92	1285 x 240

### MATERIAL

Produzido em alumínio  
Difusor opalino  
Consulte todos os acabamentos disponíveis

**PRODUTO BIVOLT (127V/220V)**  
Depende da lâmpada utilizada





IN80231BT

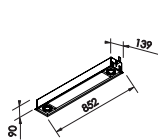

IN80231 IN80233

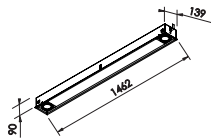

IN80236 IN80238

**3 ANOS DE GARANTIA**  
CONTRA DEFETOS DE FABRICAÇÃO

EMBUTIDO					
CÓDIGO	QUANT. LAMP.	LÂMPADA	POT. MÁX.	DIM. (mm)	NICHO
IN80231	2 xGU10/GZ10	PAR16	100W	852 x 139 x 90	126 x 839
IN80231	2 xG13	T8	36W	852 x 139 x 90	126 x 839
IN80233	2 xE27	PAR20	100W	852 x 139 x 90	126 x 839
IN80233	2 xG13	T8	36W	852 x 139 x 90	126 x 839
IN80236	2 xGU10/GZ10	PAR16	100W	1462 x 139 x 90	126 x 1449
IN80236	2 xG13	T8	72W	1462 x 139 x 90	126 x 1449
IN80238	2 xE27	PAR20	100W	1462 x 139 x 90	126 x 1449
IN80238	2 xG13	T8	72W	1462 x 139 x 90	126 x 1449

### MATERIAL

Produzido em alumínio  
Difusor opalino  
Consulte todos os acabamentos disponíveis

**PRODUTO BIVOLT (127V/220V)**  
Depende da lâmpada utilizada



## NO FRAME II | embutido

610LED3BT



615LED3BT

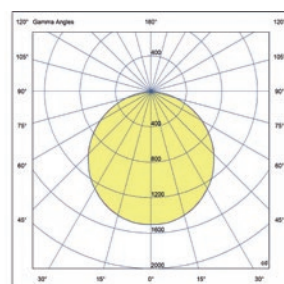
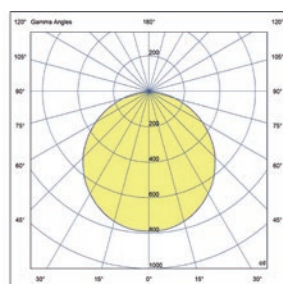
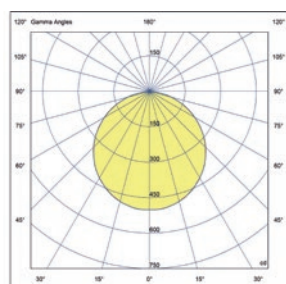
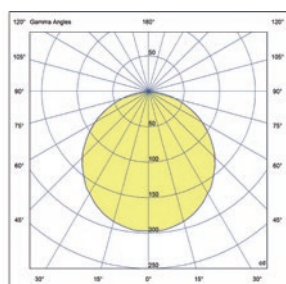

610LED

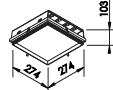

611LED

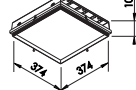

612LED

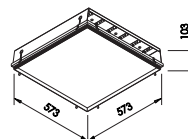

613LED

### EMBUITO

CÓDIGO	POTÊNCIA	FLUXO DA FONTE (lm)	FLUXO DA LUMINÁRIA (lm)	TEMP. COR (K)	DIM. (mm)	NICHO (mm)
610LED3	12,6W	1380	559	3000 ☉	184 x 184 x 103	214 x 214
610LED4	12,6W	1380	588	4000 ○	184 x 184 x 103	214 x 214
611LED3	32W	4400	1418	3000 ☉	274 x 274 x 103	304 x 304
611LED4	32W	4400	1493	4000 ○	274 x 274 x 103	304 x 304
612LED3	50,4W	5544	2234	3000 ☉	374 x 374 x 103	404 x 404
612LED4	50,4W	5544	2352	4000 ○	374 x 374 x 103	404 x 404
613LED3	96W	13200	4255	3000 ☉	573 x 573 x 143	603 x 603
613LED4	96W	13200	4479	4000 ○	573 x 573 x 143	603 x 603

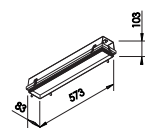

615LED

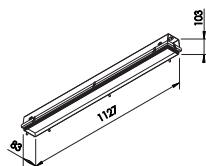
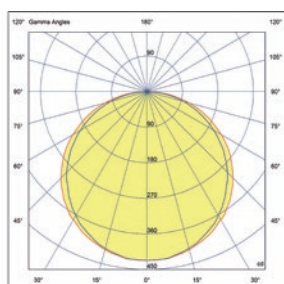

616LED

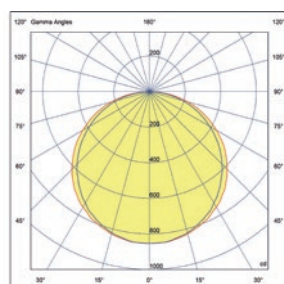

**Led LINE**  
3 ANOS DE GARANTIA  
CONTRA DEFETOS DE FABRICAÇÃO

### EMBUITO

CÓDIGO	POTÊNCIA	FLUXO DA FONTE (lm)	FLUXO DA LUMINÁRIA (lm)	TEMP. COR (K)	DIM. (mm)	NICHO (mm)
615LED3	16W	2200	1310	3000 ☉	573 x 83 x 103	603 x 103
615LED4	16W	2200	1379	4000 ○	573 x 83 x 103	603 x 103
616LED3	32W	4400	2620	3000 ☉	1127 x 83 x 103	1157 x 103
616LED4	32W	4400	2758	4000 ○	1127 x 83 x 103	1157 x 103

### MATERIAL

Produzido em alumínio  
Difusor opalino  
Consulte todos os acabamentos disponíveis

**PRODUTO BIVOLT (127V/220V)**



**NO FRAME** | embutido



IN60201BT

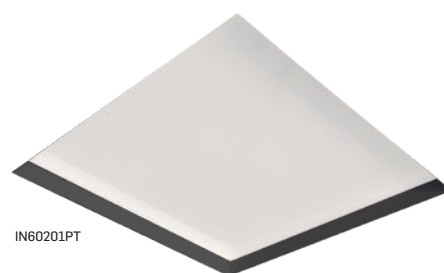

IN60201PT



IN60200



IN60201

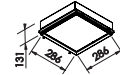

IN60202

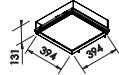

IN60203

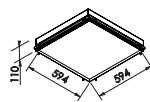

IN60216

**EMBUTIDO**

CÓDIGO	QUANT. LAMP.	LÂMPADA	POT. MÁX.	DIM. (mm)	NICHO
IN60200	2 x E27	CFL	30W	162 x 162 x 131	192 x 192
IN60201	3 x E27	CFL	75W	207 x 207 x 131	237 x 237
IN60202	4 x E27	CFL	100W	286 x 286 x 131	316 x 316
IN60203	6 x E27	CFL	150W	394 x 394 x 131	424 x 424
IN60216	4 x G13	T8	72W	596 x 596 x 131	624 x 624

**3 ANOS DE GARANTIA**  
CONTRA DEFETOS DE FABRICAÇÃO

**MATERIAL**

Produzido em alumínio  
Difusor opalino  
Consulte todos os acabamentos disponíveis

**PRODUTO BIVOLT (127V/220V)**

Depende da lâmpada utilizada



**NO FRAME** | embutido



IN60213BT

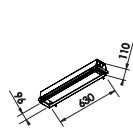

IN60211

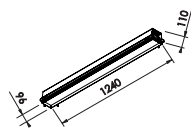

IN60213

**3 ANOS DE GARANTIA**  
CONTRA DEFETOS DE FABRICAÇÃO

#### MATERIAL

Produzido em alumínio  
Difusor opalino  
Consulte todos os acabamentos disponíveis

**PRODUTO BIVOLT (127V/220V)**  
Depende da lâmpada utilizada

EMBUTIDO					
CÓDIGO	QUANT. LAMP.	LÂMPADA	POT. MÁX.	DIM. (mm)	NICHO
IN60211	2 x G13	T8	36W	630 x 96 x 110	126 x 660
IN60213	2 x G13	T8	72W	1240 x 96 x 110	126 x 1270





**NO FRAME** | embutido



IN60231BTBT

IN60231BTPT

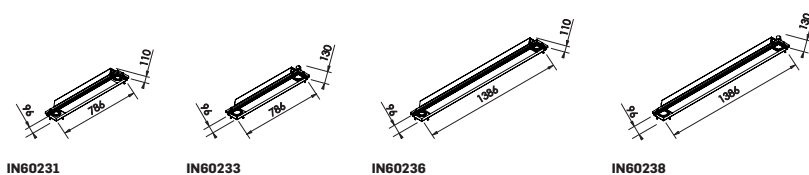
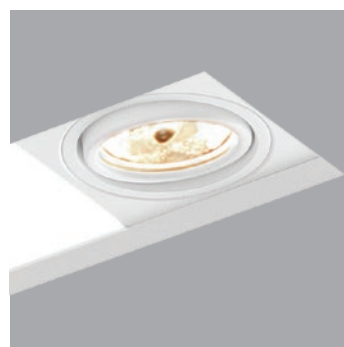

IN60231

IN60233

IN60236

IN60238

**3 ANOS DE GARANTIA**  
CONTRA DEFETOS DE FABRICAÇÃO

EMBUTIDO					
CÓDIGO	QUANT. LAMP.	LÂMPADA	POT. MÁX.	DIM. (mm)	NICHO
IN60231	2 x G13	T8	36W	786 x 96 x 110	126 x 816
IN60231	2 x GU10/GZ10	PAR16	100W	786 x 96 x 110	126 x 816
IN60233	2 x G13	T8	36W	786 x 96 x 130	126 x 816
IN60233	2 x GU10/GZ10	PAR20	100W	786 x 96 x 130	126 x 816
IN60236	2 x G13	T8	36W	1386 x 96 x 110	126 x 1416
IN60236	2 x GU10/GZ10	PAR16	100W	1386 x 96 x 110	126 x 1416
IN60238	2 x G13	T8	36W	1386 x 96 x 130	126 x 1416
IN60238	2 x GU10/GZ10	PAR20	100W	1386 x 96 x 130	126 x 1416

## MATERIAL

Produzido em alumínio  
Difusor opalino  
\*Medidas da parte visível da peça quando instalada  
Consulte todos os acabamentos disponíveis

**PRODUTO BIVOLT (127V/220V)**  
Depende da lâmpada utilizada



**NO FRAME** | embutido



IN60251BT

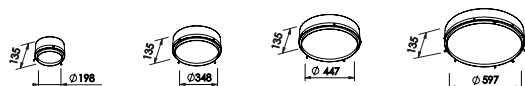

IN60250

IN60251

IN60252

IN60253

EMBUTIDO					
CÓDIGO	QUANT. LAMP.	LÂMPADA	POT. MÁX.	DIM. (mm)	NICHO
IN60250	2 x E27	CFL	50W	Ø198 x 135	Ø234
IN60251	4 x E27	CFL	100W	Ø348 x 135	Ø383
IN60252	6 x E27	CFL	150W	Ø447 x 135	Ø492
IN60253	8 x E27	CFL	200W	Ø597 x 135	Ø642

**3 ANOS DE GARANTIA**  
CONTRA DEFEITOS DE FABRICAÇÃO

### MATERIAL

Produzido em alumínio  
Difusor opalino  
Consulte todos os acabamentos disponíveis

**PRODUTO BIVOLT (127V/220V)**  
Depende da lâmpada utilizada



## INSIDE REDONDA | embutido

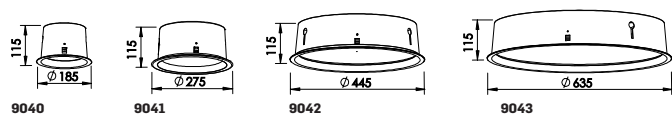

EMBUTIDO					
CÓDIGO	QUANT. LAMP.	LÂMPADA	POT. MÁX.	DIM. (mm)	NICHO
9040	1 x E27	CFL	20W	Ø185 x 115	Ø165
9041	2 x E27	CFL	40W	Ø275 x 115	Ø240
9042	4 x E27	CFL	100W	Ø445 x 115	Ø400
9043	8 x E27	CFL	200W	Ø635 x 115	Ø585



**3 ANOS DE GARANTIA**  
CONTRA DEFECTOS DE FABRICAÇÃO

### MATERIAL

Produzido em alumínio  
Difusor opalino  
Consulte todos os acabamentos disponíveis

**PRODUTO BIVOLT (127V/220V)**  
Depende da lâmpada utilizada



## FLAT | embutido



IN65002BT



IM65022BT



IN65034BT



IN65044BT

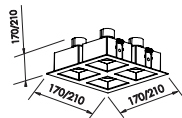
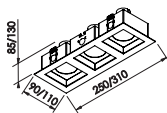
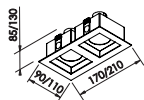
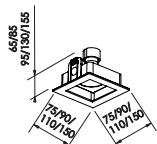

**3 ANOS DE GARANTIA**  
CONTRA DEFEITOS DE FABRICAÇÃO

### EMBUTIDO

CÓDIGO	QUANT. LAMP.	LÂMPADA	POT. MÁX.	DIM. (mm)	NICHO(mm)
IN65002	1 x GU10/GZ10	PAR16	50W	90 x 90 x 85	78 x 78
IN65003	1 x E27	PAR20	50W	110 x 110 x 85	98 x 98
IN65100	1 x GU10/GZ10	MINI DIC. LED	50W	75 x 75 x 65	63 x 63
IN65104	1 x GU10/GZ10	AR70 LED	50W	110 x 110 x 85	98 x 98
IN65106	1 x GU10/GZ10	AR111 LED	50W	150 x 150 x 95	141 x 141
IN65107	1 x E27	PAR30	75W	150 x 150 x 155	141 x 141
IN65022	2 x GU10/GZ10	PAR16	100W	90 x 170 x 85	78 x 158
IN65023	2 x E27	PAR20	100W	110 x 210 x 85	98 x 198
IN65124	2 x GU10/GZ10	AR70 LED	100W	110 x 210 x 85	98 x 198
IN65032	3 x GU10/GZ10	PAR16	150W	90 x 250 x 85	78 x 238
IN65033	3 x E27	PAR20	150W	110 x 310 x 130	98 x 298
IN65134	3 x GU10/GZ10	AR70 LED	150W	110 x 310 x 85	98 x 298
IN65042	4 GU10/GZ10	PAR16	200W	170 x 170 x 85	158 x 158
IN65043	4 E27	PAR20	200W	210 x 210 x 130	198 x 198
IN65144	4 GU10/GZ10	AR70 LED	200W	210 x 210 x 85	198 x 198

### MATERIAL

Produzido em alumínio  
Consulte todos os acabamentos disponíveis

### PRODUTO BIVOLT (127V/220V)

Depende da lâmpada utilizada



## FLAT FOCO | embutido direcionável

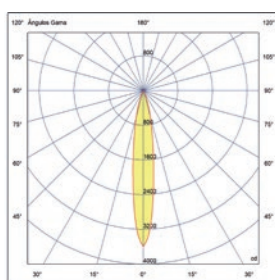

EM0440LED

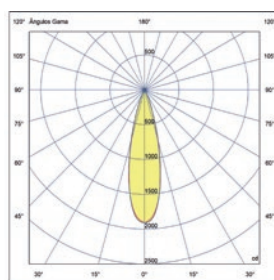
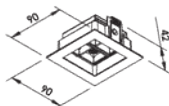

EM0441LED

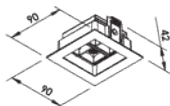

LedLINE

**3 ANOS DE GARANTIA**  
CONTRA DEFETOS DE FABRICAÇÃO

### EMBUTIDO FOCO

CÓDIGO	POTÊNCIA	FLUXO FONTE LUMINOSA (lm)	FLUXO LUMINÁRIA (lm)	TEMP. COR (K)	FOCO	DIM. (mm)	NICHO (mm)
EM0440LED3	4W	600	433	3000	10°	90 x 90 x 45	81 x 81
EM0440LED4	4W	600	456	4000	10°	90 x 90 x 45	81 x 81
EM0441LED3	4W	600	436	3000	24°	90 x 90 x 45	81 x 81
EM0441LED4	4W	600	460	4000	24°	90 x 90 x 45	81 x 81

### MATERIAL

Produzido em alumínio  
Consulte todos os acabamentos disponíveis

**PRODUTO BIVOLT (127V/220V)**



## LISSE II | embutido



IN55501BT



IN55542BT



IN55533BT



IN55544BT

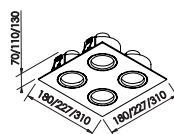
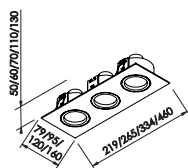
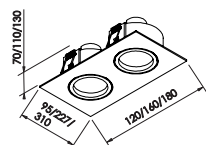
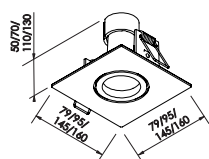

EMBUTIDO					
CÓDIGO	QUANT. LAMP.	LÂMPADA	POT. MÁX.	DIM. (mm)	NICHO(mm)
IN55501	1 x GU10/GZ10	MINI DIC. LED	40W	79 x 79 x 50	Ø66
IN55521	1 x GU10/GZ10	PAR16	50W	95 x 95 x 70	Ø80
IN55531	1 x E27	PAR20	50W	120 x 120 x 110	Ø100
IN55541	1 x GU10/GZ10	AR70 LED	50W	120 x 120 x 70	Ø100
IN55551	1 x GU10/GZ10	AR111 LED	50W	160 x 160 x 70	Ø145
IN55561	1 x E27	PAR30	75W	160 x 160 x 130	Ø145
IN55522	2 x GU10/GZ10	PAR16	100W	95 x 180 x 70	75 x 160
IN55532	2 x E27	PAR20	100W	227 x 120 x 110	100 x 205
IN55542	2 x GU10/GZ10	AR70 LED	100W	227 x 120 x 70	100 x 205
IN55552	2 x GU10/GZ10	AR111 LED	100W	310 x 160 x 70	145 x 290
IN55562	2 x E27	PAR30	150W	310 x 160 x 130	145 x 290
IN55523	3 x GU10/GZ10	PAR16	150W	95 x 265 x 70	75 x 245
IN55533	3 x E27	PAR20	150W	120 x 334 x 110	100 x 310
IN55543	3 x GU10/GZ10	AR70 LED	150W	334 x 120 x 70	100 x 310
IN55553	3 x GU10/GZ10	AR111 LED	150W	460 x 160 x 70	145 x 440
IN55563	3 x E27	PAR30	225W	460 x 160 x 130	145 x 440
IN55524	4 GU10/GZ10	PAR16	200W	180 x 180 x 70	160 x 160
IN55534	4 E27	PAR20	200W	227 x 227 x 110	205 x 205
IN55544	4 GU10/GZ10	AR70 LED	200W	227 x 227 x 70	205 x 205
IN55554	4 GU10/GZ10	AR111 LED	200W	310 x 310 x 130	295 x 295
IN55564	4 E27	PAR30	300W	310 x 310 x 130	295 x 295

**3 ANOS DE GARANTIA**  
CONTRA DEFETOS DE FABRICAÇÃO

### MATERIAL

Produzido em alumínio  
Consulte todos os acabamentos disponíveis

### PRODUTO BIVOLT (127V/220V)

Depende da lâmpada utilizada



## RECUADO II | embutido



IN51351BT



IN51352BT



IN50333BT



IN50334BT

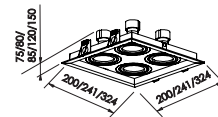
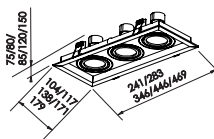
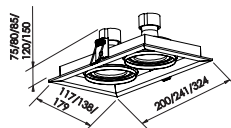
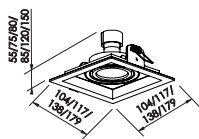

EMBUTIDO					
CÓDIGO	QUANT. LAMP.	LÂMPADA	POT. MÁX.	DIM. (mm)	NICHO(mm)
IN50321	1 x GU10/GZ10	PAR16	50W	117 x 117 x 75	103 x 103
IN50331	1 x E27	PAR20	50W	138 x 138 x 120	124 x 124
IN51301	1 x GU10/GZ10	MINI DIC. LED	50W	104 x 104 x 55	90 x 90
IN51341	1 x GU10/GZ10	AR70 LED	50W	138 x 138 x 80	124 x 124
IN51351	1 x GU10/GZ10	AR111 LED	50W	179 x 179 x 85	165 x 165
IN51361	1 x E27	PAR30	75W	179 x 179 x 150	165 x 165
IN50322	2 x GU10/GZ10	PAR16	100W	117 x 200 x 75	103 x 186
IN50332	2 x E27	PAR20	100W	138 x 241 x 120	124 x 227
IN51342	2 x GU10/GZ10	AR70 LED	100W	138 x 241 x 80	124 x 227
IN51352	2 x GU10/GZ10	AR111 LED	100W	179 x 324 x 85	165 x 310
IN51362	2 x E27	PAR30	150W	179 x 324 x 150	165 x 310
IN50323	3 x GU10/GZ10	PAR16	150W	117 x 283 x 75	103 x 269
IN50333	3 x E27	PAR20	150W	138 x 346 x 120	124 x 334
IN51343	3 x GU10/GZ10	AR70 LED	150W	138 x 346 x 80	124 x 332
IN51353	3 x GU10/GZ10	AR111 LED	150W	179 x 469 x 85	165 x 455
IN51363	3 x E27	PAR30	225W	179 x 469 x 150	165 x 455
IN50324	4 GU10/GZ10	PAR16	200W	200 x 200 x 75	186 x 186
IN50334	4 E27	PAR20	200W	241 x 241 x 120	227 x 227
IN51344	4 GU10/GZ10	AR70 LED	200W	241 x 241 x 80	227 x 227
IN51354	4 GU10/GZ10	AR111 LED	200W	324 x 324 x 85	310 x 310
IN51364	4 E27	PAR30	300W	324 x 324 x 150	310 x 310

**3 ANOS DE GARANTIA**  
CONTRA DEFETOS DE FABRICAÇÃO

### MATERIAL

Produzido em alumínio.  
Consulte todos os acabamentos disponíveis

**PRODUTO BIVOLT (127V/220V)**  
Depende da lâmpada utilizada



## NO FRAME II | embutido



IN61341BT



IN61342BT



IN61343BT



IN61344BT

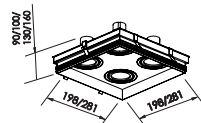
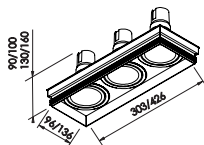
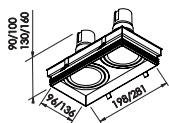
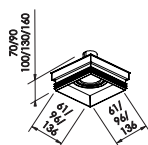

EMBUTIDO					
CÓDIGO	QUANT. LAMP.	LÂMPADA	POT. MÁX.	DIM. (mm)	NICHO(mm)
IN60321	1 x GU10/GZ10	PAR16	50W	96 x 96 x 90	115 x 115
IN60331	1 x E27	PAR20	50W	96 x 96 x 130	115 x 115
IN60361	1 x E27	PAR30	75W	136 x 136 x 160	155 x 155
IN61301	1 x GU10/GZ10	MINI DIC. LED	50W	61 x 61 x 70	80 x 80
IN61341	1 x GU10/GZ10	AR70 LED	50W	96 x 96 x 100	115 x 115
IN61351	1 x GU10/GZ10	AR111 LED	50W	136 x 136 x 100	155 x 155
IN60322	2 x GU10/GZ10	PAR16	100W	98 x 198 x 90	115 x 217
IN60332	2 x E27	PAR20	100W	98 x 198 x 130	115 x 217
IN60362	2 x E27	PAR30	150W	136 x 281 x 160	155 x 300
IN61342	2 x GU10/GZ10	AR70 LED	100W	96 x 198 x 100	115 x 217
IN61352	2 x GU10/GZ10	AR111 LED	100W	136 x 281 x 100	155 x 300
IN60323	3 x GU10/GZ10	PAR16	150W	96 x 303 x 90	115 x 322
IN60333	3 x E27	PAR20	150W	96 x 303 x 130	115 x 322
IN60363	3 x E27	PAR30	225W	136 x 426 x 160	155 x 445
IN61343	3 x GU10/GZ10	AR70 LED	150 W	96 x 303 x 100	115 x 322
IN61353	3 x GU10/GZ10	AR111 LED	150W	136 x 426 x 100	155 x 455
IN60324	4 x GU10/GZ10	PAR16	200W	198 x 198 x 90	217 x 217
IN60334	4 x E27	PAR20	200W	198 x 198 x 130	217 x 217
IN60364	4 x E27	PAR30	300W	281 x 281 x 160	300 x 300
IN61344	4 x GU10/GZ10	AR70 LED	200W	198 x 198 x 100	217 x 217
IN61354	4 x GU10/GZ10	AR111 LED	200W	281 x 281 x 100	300 x 300

**3 ANOS DE GARANTIA**  
CONTRA DEFETOS DE FABRICAÇÃO

### MATERIAL

Produzido em alumínio  
Consulte todos os acabamentos disponíveis

### PRODUTO BIVOLT (127V/220V)

Depende da lâmpada utilizada





## NO FRAME FOCO | embutido No Frame

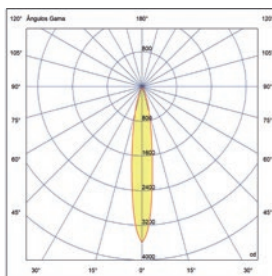
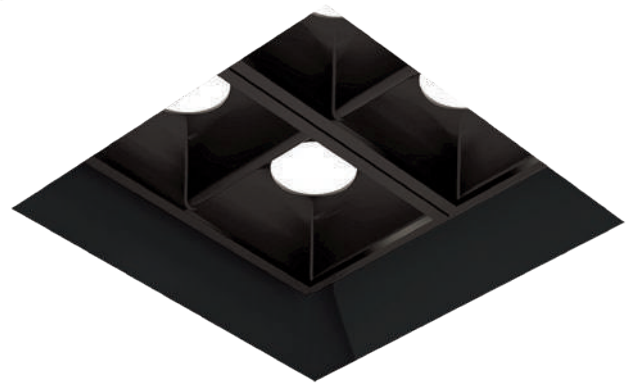

EM0445LED

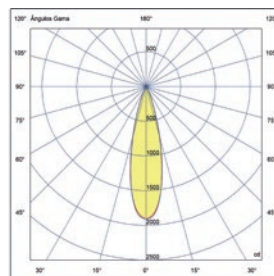
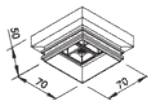

EM0446LED

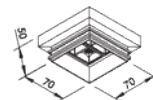

LedLINE

**3 ANOS DE GARANTIA**  
CONTRA DEFETOS DE FABRICAÇÃO

EMBUITO FOCO							
CÓDIGO	POTÊNCIA	FLUXO FONTE LUMINOSA (lm)	FLUXO LUMINÁRIA (lm)	TEMP. COR (K)	FOCO	DIM. (mm)	NICHO (mm)
EM0445LED3	4W	600	433	3000	10°	70 x 70 x 50	97 x 97
EM0445LED4	4W	600	456	4000	10°	70 x 70 x 50	97 x 97
EM0446LED3	4W	600	436	3000	24°	70 x 70 x 50	97 x 97
EM0446LED4	4W	600	460	4000	24°	70 x 70 x 50	97 x 97

### MATERIAL

Produzido em alumínio  
Consulte todos os acabamentos disponíveis

**PRODUTO BIVOLT (127V/220V)**



## NO FRAME REDONDO | embutido



IN60521BR



IN60531BR



IN60541BR



IN60551BR



IN60561BR



IN60521PT



IN60531PT



IN60541PT



IN60551PT



IN60561PT

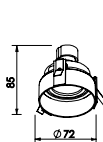

IN60521

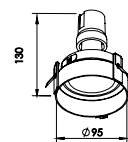

IN60531

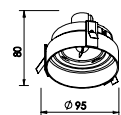

IN60541

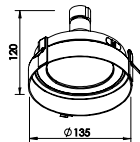

IN60551

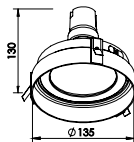

IN60561

**3 ANOS DE GARANTIA**  
CONTRA DEFETOS DE FABRICAÇÃO

EMBUTIDO					
CÓDIGO	QUANT. LAMP.	LÂMPADA	POT. MÁX.	DIM. (mm)	NICHO(mm)
IN60521	1 x GU10/GZ10	PAR16	50W	Ø72 x 85	80
IN60531	1 x E27	PAR20	50W	Ø95 x 130	100
IN60541	1 x GU10/GZ10	AR70 LED	50W	Ø95 x 80	100
IN60551	1 x GU10/GZ10	AR111 LED	50W	Ø135 x 120	142
IN60561	1 x E27	PAR30	75W	Ø135 x 130	142

### MATERIAL

Produzido em alumínio  
Consulte todos os acabamentos disponíveis

### PRODUTO BIVOLT (127V/220V)

Depende da lâmpada utilizada



## LISSE II PIN HOLE | embutido



IN50931BT



IN50931PT

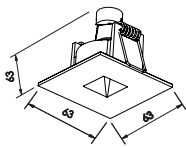

IN50931

### EMBUTIDO

CÓDIGO	QUANT. LAMP.	LÂMPADA	POT. MÁX.	DIM. (mm)	NICHO(mm)
IN50931	1 x GU10/GZ10	MINI DIC. LED	50w	63 x 63 x 70	Ø52

**3 ANOS DE GARANTIA**  
CONTRA DEFETOS DE FABRICAÇÃO

### MATERIAL

Produzido em alumínio  
Consulte todos os acabamentos disponíveis

**PRODUTO BIVOLT (127V/220V)**  
Depende da lâmpada utilizada



## ACESSÓRIOS PARA TRILHO



TRILHO ELETRIFICADO



CONECTOR RETO



CONECTOR L



CONECTOR T



CONECTOR X

### ACESSÓRIOS PARA TRILHO

CÓDIGO	DESCRIÇÃO	MODELO	COR
931000	TRILHO ELETRIFICADO	1M	BRANCO
931001	TRILHO ELETRIFICADO	1M	PRETO
931002	TRILHO ELETRIFICADO	1,5M	BRANCO
931003	TRILHO ELETRIFICADO	1,5M	PRETO
931004	TRILHO ELETRIFICADO	2M	BRANCO
931005	TRILHO ELETRIFICADO	2M	PRETO
931006	CONECTOR RETO		BRANCO
931007	CONECTOR RETO		PRETO
931008	CONECTOR L		BRANCO
931009	CONECTOR L		PRETO
931010	CONECTOR T		BRANCO
931011	CONECTOR T		PRETO
931012	CONECTOR X		BRANCO
931013	CONECTOR X		PRETO

**3 ANOS DE GARANTIA**  
CONTRA DEFEITOS DE FABRICAÇÃO

### MATERIAL

Produzido em alumínio.  
Consulte todos os acabamentos disponíveis





**Adaptador para trilho super compacto.**

- Alta durabilidade e resistência
- Sistema elétrico otimizado
- Seguro e prático
- Fácil instalação



**3 ANOS DE GARANTIA**  
CONTRA DEFETOS DE FABRICAÇÃO

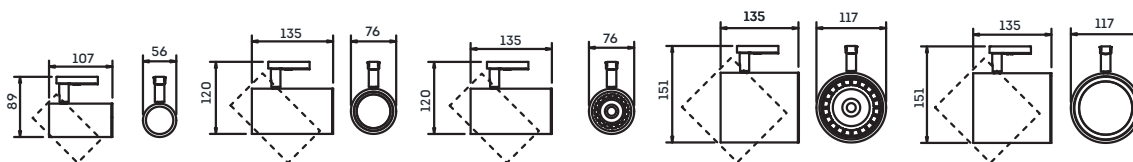

IN50925

IN50935

IN50945

IN50955

IN50965

**SPOT TRILHO**

CÓDIGO	QUANT. LAMP.	LÂMPADA	POT. MÁX.	DIM. (mm)
IN50925	1 x GU10/GZ10	PAR16	50W	107 x 56 x 89
IN50935	1 x E27	PAR20	50W	135 x 76 x 120
IN50945	1 x GU10/GZ10	AR70 LED	50W	135 x 76 x 120
IN50955	1 x GU10/GZ10	AR111 LED	50W	135 x 117 x 151
IN50965	1 x E27	PAR30	75W	135 x 117 x 151

**MATERIAL**

Produzido em alumínio  
Para uso com trilhos eletrificados  
Consulte todos os acabamentos disponíveis

**PRODUTO BIVOLT (127V/220V)**

Depende da lâmpada utilizada



## LISSE SOLUTION II | spot



**3 ANOS DE GARANTIA**  
CONTRA DEFETOS DE FABRICAÇÃO

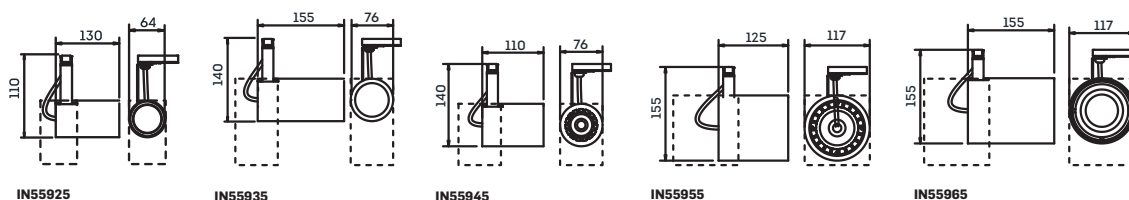

IN55925

IN55935

IN55945

IN55955

IN55965

### SPOT TRILHO

CÓDIGO	QUANT. LAMP.	LÂMPADA	POT. MÁX.	DIM. (mm)
IN55925	1 x GU10/GZ10	PAR16	50W	110 x 64 x 130
IN55935	1 x E27	PAR20	50W	155 x 76 x 140
IN55945	1 x GU10/GZ10	AR70 LED	50W	110 x 76 x 140
IN55955	1 x GU10/GZ10	AR111 LED	50W	125 x 117 x 155
IN55965	1 x E27	PAR30	75W	155 x 117 x 155

### MATERIAL

Produzido em alumínio  
Para uso com trilhos eletrificados  
Consulte todos os acabamentos disponíveis

### PRODUTO BIVOLT (127V/220V)

Depende da lâmpada utilizada





## LISSE SOLUTION II | spot



IN55625PT



IN55655BT

**3 ANOS DE GARANTIA**  
CONTRA DEFETOS DE FABRICAÇÃO

FOCO AJUSTÁVEL A 90°

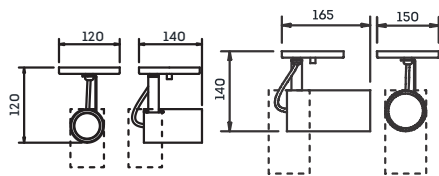

IN55625

IN55635

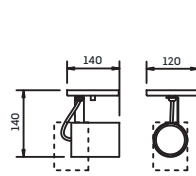

IN55645

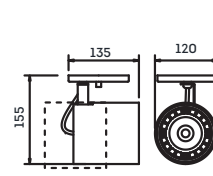

IN55655

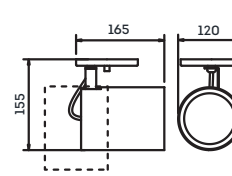

IN55665

### SPOT DE SOBREPOR

CÓDIGO	QUANT. LAMP.	LÂMPADA	POT. MÁX.	DIM. (mm)
IN55625	1 x GU10/GZ10	PAR16	50W	120 x 140 x 120
IN55635	1 x E27	PAR20	50W	165 x 150 x 140
IN55645	1 x GU10/GZ10	AR70 LED	50W	140 x 120 x 140
IN55655	1 x GU10/GZ10	AR111 LED	50W	120 x 135 x 155
IN55665	1 x E27	PAR30	75W	120 x 165 x 155

### MATERIAL

Produzido em alumínio  
Consulte todos os acabamentos disponíveis

### PRODUTO BIVOLT (127V/220V)

Depende da lâmpada utilizada





# LISSE SOLUTION II | spot



IN55626PT



IN55647BT

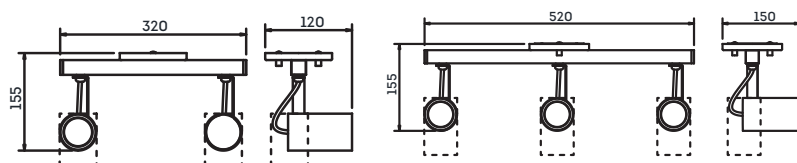

IN55626

IN55627

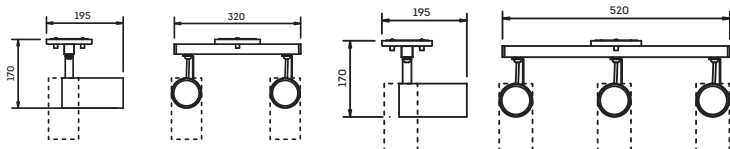

IN55636

IN55637

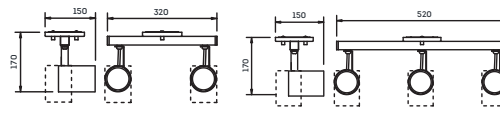

IN55646

IN55647

**3 ANOS DE GARANTIA**  
CONTRA DEFETOS DE FABRICAÇÃO

## SPOT DE SOBREPOR

CÓDIGO	QUANT. LAMP.	LÂMPADA	POT. MÁX.	DIM. (mm)
IN55626	2 x GU10/GZ10	PAR16	100W	320 x 150 x 155
IN55627	3 x GU10/GZ10	PAR16	150W	520 x 150 x 155
IN55636	2 x E27	PAR20	100W	320 x 195 x 170
IN55637	3 x E27	PAR20	150W	520 x 195 x 170
IN55646	2 x GU10/GZ10	AR70 LED	100W	320 x 150 x 170
IN55647	3 x GU10/GZ10	AR70 LED	150W	520 x 150 x 170

## MATERIAL

Produzido em alumínio  
Consulte todos os acabamentos disponíveis

## PRODUTO BIVOLT (127V/220V)

Depende da lâmpada utilizada



## PORTARA | arandela



SN10120BTBT

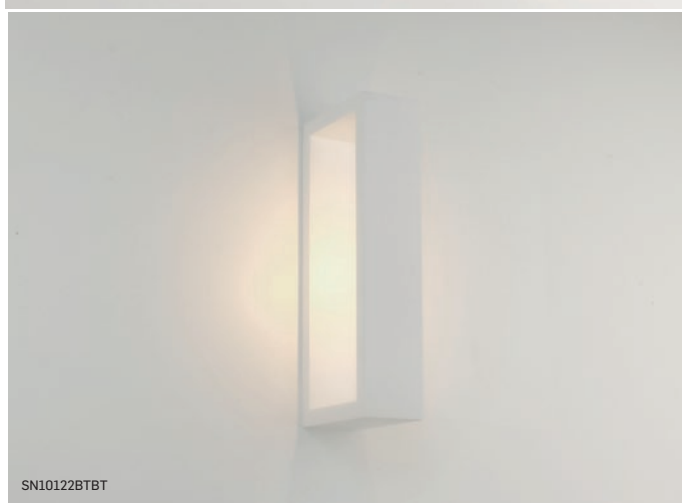

SN10122BTBT

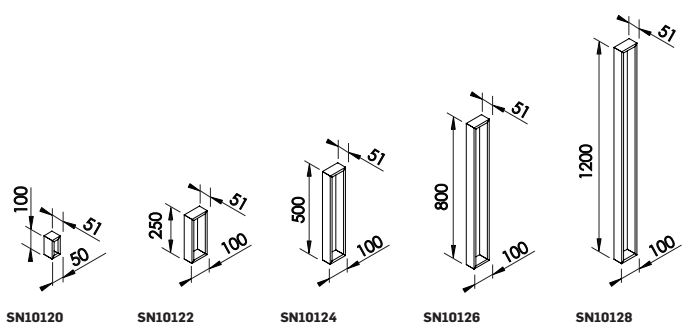

ARANDELA					
CÓDIGO	POTÊNCIA	FLUXO DA FONTE (lm)	TEMP. COR (K)	DIM. (mm)	TENSÃO DE REDE
SN10120	6W	400	2700 ☉	51 x 50 x 100	127V
SN10121	6W	400	2700 ☉	51 x 50 x 100	220V
SN10122	6W	400	2700 ☉	51 x 100 x 250	127V
SN10123	6W	400	2700 ☉	51 x 100 x 250	220V
SN10124	18W	1200	2700 ☉	51 x 100 x 500	127V
SN10125	18W	1200	2700 ☉	51 x 100 x 500	220V
SN10126	30W	2000	2700 ☉	51 x 100 x 800	127V
SN10127	30W	2000	2700 ☉	51 x 100 x 800	220V
SN10128	48W	3200	2700 ☉	51 x 100 x 1200	127V
SN10129	48W	3200	2700 ☉	51 x 100 x 1200	220V

Led LINE

**3 ANOS DE GARANTIA**  
CONTRA DEFEITOS DE FABRICAÇÃO

### MATERIAL

Produzido em alumínio  
Consulte todos os acabamentos disponíveis





SN10140BTBT

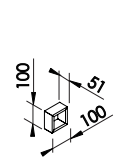

SN10140

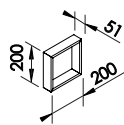

SN10142

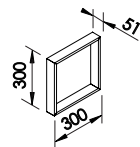

SN10144

ARANDELA					
CÓDIGO	POTÊNCIA	FLUXO DA FONTE (lm)	TEMP. COR (K)	DIM. (mm)	TENSÃO DE REDE
SN10140	6W	400	2700	51 x 100 x 100	127V
SN10141	6W	400	2700	51 x 100 x 100	220V
SN10142	6W	400	2700	51 x 200 x 200	127V
SN10143	6W	400	2700	51 x 200 x 200	220V
SN10144	12W	800	2700	51 x 300 x 300	127V
SN10145	12W	800	2700	51 x 300 x 300	220V

LedLINE

**3 ANOS DE GARANTIA**  
CONTRA DEFETOS DE FABRICAÇÃO

**MATERIAL**

Produzido em alumínio  
Consulte todos os acabamentos disponíveis





IN50817BT



IN50817PT



**Outdoor**  
PODE SER UTILIZADO EM ÁREAS EXTERNAS

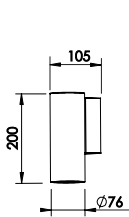

IN50817

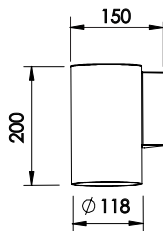

IN50818



**3 ANOS DE GARANTIA**  
CONTRA DEFECTOS DE FABRICAÇÃO

### MATERIAL

Produzido em alumínio  
Índice de Proteção: IP03  
Pode ser utilizada em áreas externas  
Consulte todos os acabamentos disponíveis

**PRODUTO BIVOLT (127V/220V)**  
Depende da lâmpada utilizada

ARANDELA				
CÓDIGO	QUANT. LAMP.	LÂMPADA	POT. MÁX.	DIM. (mm)
IN50817	1 x E27	A60	50W	Ø76 x 105 x 200
IN50818	1 x E27	PAR30	75W	Ø118 x 150 x 200





SNT022LED1BT

Outdoor   
PODE SER UTILIZADO EM ÁREAS EXTERNAS

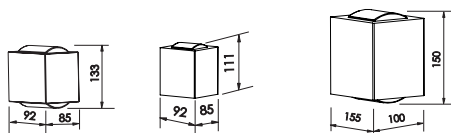







SNT022LED

SNT024LED

SNT026LED

Led LINE 

**3 ANOS DE GARANTIA**  
CONTRA DEFEITOS DE FABRICAÇÃO

ARANDELA						
CÓDIGO	POTÊNCIA	FLUXO DA FONTE (lm)	TEMP. COR (K)	DIM. (mm)	TENSÃO DE REDE	DIFUSOR
SNT022LED1	12W	800	2700 	85 x 133 x 92	127V	LENTE/LENTE
SNT022LED2	12W	800	2700 	85 x 133 x 92	220V	LENTE/LENTE
SNT024LED1	6W	400	2700 	85 x 111 x 92	127V	LENTE
SNT024LED2	6W	400	2700 	85 x 111 x 92	220V	LENTE
SNT026LED1	12W	800	2700 	100 x 150 x 155	127V	LENTE/LENTE
SNT026LED2	12W	800	2700 	100 x 150 x 155	220V	LENTE/LENTE

#### MATERIAL

Produzido em alumínio e vidro  
Índice de Proteção: IP43  
Consulte todos os acabamentos disponíveis





9584LED

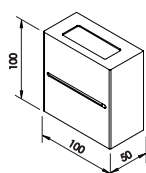

**3 ANOS DE GARANTIA**  
CONTRA DEFECTOS DE FABRICAÇÃO

**MATERIAL**

Produzido em alumínio e vidro  
Índice de Proteção: IP43  
Consulte todos os acabamentos disponíveis



ARANDELA						
CÓDIGO	POTÊNCIA	FLUXO DA FONTE (lm)	TEMP. COR (K)	DIM. (mm)	TENSÃO DE REDE	LUZ
9584LED1	12W	800	2700 ☉	100 x 50 x 100	127V	2 fachos de luz
9584LED2	12W	800	2700 ☉	100 x 50 x 100	220V	2 fachos de luz



9585LED

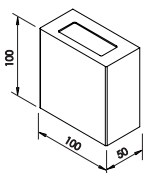

**3 ANOS DE GARANTIA**  
CONTRA DEFECTOS DE FABRICAÇÃO

**MATERIAL**

Produzido em alumínio e vidro  
Índice de Proteção: IP43  
Consulte todos os acabamentos disponíveis



ARANDELA						
CÓDIGO	POTÊNCIA	FLUXO DA FONTE (lm)	TEMP. COR (K)	DIM. (mm)	TENSÃO DE REDE	LUZ
9585LED1	12W	800	2700 ☉	100 x 50 x 100	127V	2 fachos de luz
9585LED2	12W	800	2700 ☉	100 x 50 x 100	220V	2 fachos de luz



9587LED

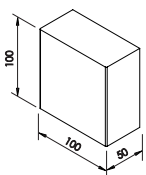

**3 ANOS DE GARANTIA**  
CONTRA DEFECTOS DE FABRICAÇÃO

**MATERIAL**

Produzido em alumínio e vidro  
Índice de Proteção: IP43  
Consulte todos os acabamentos disponíveis



ARANDELA						
CÓDIGO	POTÊNCIA	FLUXO DA FONTE (lm)	TEMP. COR (K)	DIM. (mm)	TENSÃO DE REDE	LUZ
9587LED1	6W	400	2700 ☉	100 x 50 x 100	127V	1 fecho de luz
9587LED2	6W	400	2700 ☉	100 x 50 x 100	220V	1 fecho de luz



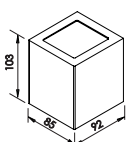

LedLINE

**3 ANOS DE GARANTIA**  
CONTRA DEFETOS DE FABRICAÇÃO

**MATERIAL**

Produzido em alumínio e vidro  
Índice de Proteção: IP43  
Consulte todos os acabamentos disponíveis

Outdoor  
PODE SER UTILIZADO EM ÁREAS EXTERNAS

ARANDELA						
CÓDIGO	POTÊNCIA	FLUXO DA FONTE (lm)	TEMP. COR (K)	DIM. (mm)	TENSÃO DE REDE	LUZ
9586LED1	12W	800	2700 ☉	85 x 92 x 103	127V	2 fachos de luz
9586LED2	12W	800	2700 ☉	85 x 92 x 103	220V	2 fachos de luz

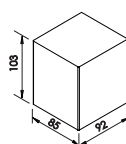

LedLINE

**3 ANOS DE GARANTIA**  
CONTRA DEFETOS DE FABRICAÇÃO

**MATERIAL**

Produzido em alumínio e vidro  
Índice de Proteção: IP43  
Consulte todos os acabamentos disponíveis

Outdoor  
PODE SER UTILIZADO EM ÁREAS EXTERNAS

ARANDELA						
CÓDIGO	POTÊNCIA	FLUXO DA FONTE (lm)	TEMP. COR (K)	DIM. (mm)	TENSÃO DE REDE	LUZ
9588LED1	6W	400	2700 ☉	85 x 92 x 103	127V	1 fecho de luz
9588LED2	6W	400	2700 ☉	85 x 92 x 103	220V	1 fecho de luz





IN10470LEDBTDO

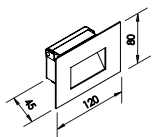

Formato ideal para aplicação em caixa de luz 4"x2"



IN10470LED / IN10471LED

LedLINE

**3 ANOS DE GARANTIA**  
CONTRA DEFETOS DE FABRICAÇÃO

ARANDELA					
CÓDIGO	POTÊNCIA	FLUXO DA FONTE (lm)	TEMP. COR (K)	DIM. (mm)	TENSÃO DE REDE
IN10470LED	6W	400	2700 ☉	120 x 45 x 80	127V
IN10471LED	6W	400	2700 ☉	120 x 45 x 80	220V

### MATERIAL

Produzido em alumínio  
Consulte todos os acabamentos disponíveis





## ÍNDICE POR CÓDIGO

CÓDIGO	PG	CÓDIGO	PG	CÓDIGO	PG	CÓDIGO	PG	CÓDIGO	PG
109	66	441LED1	81	547LED4	82	644LED3	22	762LED4	94
111	66	441LED2	81	580LED3	40	644LED4	22	9584LED1	134
112	66	442LED1	81	580LED4	40	645LED3	25	9584LED2	134
113	66	442LED2	81	581LED3	40	645LED4	25	9585LED1	134
150	68	450LED1	80	581LED4	40	646LED3	25	9585LED2	134
151	68	450LED2	80	582LED3	40	646LED4	25	9586LED1	135
152	68	451LED1	80	582LED4	40	647LED3	25	9586LED2	135
153	68	451LED2	80	585LED3	42	647LED4	25	9587LED1	134
160	54	452LED1	80	585LED4	42	655LED3	24	9587LED2	134
161	54	452LED2	80	586LED3	42	655LED4	24	9588LED1	135
162	54	470LED3	50	586LED4	42	656LED3	24	9588LED2	135
165	55	470LED4	50	587LED3	42	656LED4	24	EMO121LED3	14
166	55	471LED3	50	587LED4	42	657LED3	24	EMO121LED4	14
167	55	471LED4	50	590LED3	102	657LED4	24	EMO122LED3	14
170	62	472LED3	50	590LED4	102	661LED3	27	EMO122LED4	14
171	62	472LED4	50	591LED3	102	661LED4	27	EMO123LED3	14
172	62	480LED3	51	591LED4	102	662LED3	27	EMO123LED4	14
175	62	480LED4	51	592LED3	102	662LED4	27	EMO124LED3	14
180	63	481LED3	51	592LED4	102	680LED3	28	EMO124LED4	14
181	63	481LED4	51	593LED3	102	680LED4	28	EMO125LED3	14
185	63	482LED3	51	593LED4	102	681LED3	28	EMO125LED4	14
420	76	482LED4	51	595LED3	102	681LED4	28	EMO127LED3	10
421	74	486LED3	52	595LED4	102	685LED3	29	EMO127LED4	10
425	76	486LED4	52	596LED3	102	685LED4	29	EMO128LED3	10
426	74	490LED3	48	596LED4	102	686LED3	29	EMO128LED4	10
430	76	490LED4	48	600LED3	106	686LED4	29	EMO440LED3	117
435	76	491LED3	48	600LED4	106	690LED3	19	EMO440LED4	117
551	73	491LED4	48	601LED3	106	690LED4	19	EMO441LED3	117
552	73	492LED3	48	601LED4	106	691LED3	19	EMO441LED4	117
9040	115	492LED4	48	602LED3	106	691LED4	19	EMO445LED3	121
9041	115	493LED3	48	602LED4	106	700LED3	16	EMO445LED4	121
9042	115	493LED4	48	603LED3	106	700LED4	16	EMO446LED3	121
9043	115	496LED3	49	603LED4	106	701LED3	16	EMO446LED4	121
9045	60	496LED4	49	605LED3	106	701LED4	16	IN10470LED	136
9046	60	500LED3	44	605LED4	106	702LED3	16	IN10471LED	136
9047	60	500LED4	44	606LED3	106	702LED4	16	IN40020	78
9085	61	501LED3	44	606LED4	106	705LED3	18	IN40021	78
9086	61	501LED4	44	610LED3	110	705LED4	18	IN40080	47
11789	64	502LED3	44	610LED4	110	706LED3	18	IN40081	47
11790	64	502LED4	44	611LED3	110	706LED4	18	IN40082	47
11791	64	510LED3	45	611LED4	110	710LED3	30	IN40121	86
931000	124	510LED4	45	612LED3	110	710LED4	30	IN40122	86
931001	124	511LED3	45	612LED4	110	711LED3	30	IN40131	86
931002	124	511LED4	45	613LED3	110	711LED4	30	IN40132	86
931003	124	512LED3	45	613LED4	110	715LED3	31	IN40301	99
931004	124	512LED4	45	615LED3	110	715LED4	31	IN40306	99
931005	124	516LED3	46	615LED4	110	716LED3	31	IN40311	101
931006	124	516LED4	46	616LED3	110	716LED4	31	IN40316	101
931007	124	530LED3	53	616LED4	110	750LED3	20	IN40321	98
931008	124	530LED4	53	630LED3	21	750LED4	20	IN40326	98
931009	124	531LED3	53	630LED4	21	751LED3	20	IN40331	100
931010	124	531LED4	53	631LED3	21	751LED4	20	IN40336	100
931011	124	540LED3	83	631LED4	21	752LED3	20	IN41141	86
931012	124	540LED4	83	632LED3	21	752LED4	20	IN41142	86
931013	124	541LED3	83	632LED4	21	755LED3	20	IN41151	86
340LED1	78	541LED4	83	636LED3	26	755LED4	20	IN41152	86
340LED2	78	542LED3	83	636LED4	26	756LED3	20	IN50231	105
341LED1	78	542LED4	83	637LED3	26	756LED4	20	IN50233	105
341LED2	78	545LED3	82	637LED4	26	757LED3	20	IN50236	105
342LED1	78	545LED4	82	641LED3	23	757LED4	20	IN50238	105
342LED2	78	546LED3	82	641LED4	23	760LED3	94	IN50321	119
440LED1	81	546LED4	82	643LED3	22	760LED4	94	IN50322	119
440LED2	81	547LED3	82	643LED4	22	762LED3	94	IN50323	119



## ÍNDICE POR CÓDIGO

CÓDIGO	PG	CÓDIGO	PG	CÓDIGO	PG	CÓDIGO	PG	CÓDIGO	PG
IN50324	119	IN55955	126	IN8016	108	PLO370LED3	95	SNT022LED2	133
IN50331	119	IN55965	126	IN8017	108	PLO370LED4	95	SNT024LED1	133
IN50332	119	IN60200	111	IN80231	109	PLO371LED3	95	SNT024LED2	133
IN50333	119	IN60201	111	IN80233	109	PLO371LED4	95	SNT026LED1	133
IN50334	119	IN60202	111	IN80236	109	PLO372LED3	95	SNT026LED2	133
IN50525	92	IN60203	111	IN80238	109	PLO372LED4	95	SNT345	72
IN50535	92	IN60211	112	IN9000/2	103	PLO373LED3	95	SNT346	72
IN50800	77	IN60213	112	IN9001	103	PLO373LED4	95	SNT366	70
IN50817	132	IN60216	111	IN9002	103	PLO374LED3	95	SNT367	70
IN50818	132	IN60231	113	IN9003	103	PLO374LED4	95	ST20200	58
IN50925	125	IN60233	113	IN9007	104	PLO381LED3	84	ST20201	58
IN50931	123	IN60236	113	IN9008	104	PLO381LED4	84	ST20202	58
IN50935	125	IN60238	113	IN9012A	103	PLO383LED3	84	ST20204	59
IN50945	125	IN60250	114	IN9016	104	PLO383LED4	84	ST20205	59
IN50955	125	IN60251	114	IN9017	104	PLO391LED3	85	ST20206	59
IN50965	125	IN60252	114	PD02004LED3	36	PLO391LED4	85		
IN51301	119	IN60253	114	PD02004LED4	36	PLO393LED3	85		
IN51341	119	IN60321	120	PD02005LED3	36	PLO393LED4	85		
IN51342	119	IN60322	120	PD02005LED4	36	PLO440LED3	90		
IN51343	119	IN60323	120	PD0371LED3	97	PLO440LED4	90		
IN51344	119	IN60324	120	PD0371LED4	97	PLO441LED3	90		
IN51351	119	IN60331	120	PD0372LED3	97	PLO441LED4	90		
IN51352	119	IN60332	120	PD0372LED4	97	PLO442LED3	90		
IN51353	119	IN60333	120	PD0373LED3	97	PLO442LED4	90		
IN51354	119	IN60334	120	PD0373LED4	97	PLO445LED3	90		
IN51361	119	IN60361	120	PD0374LED3	97	PLO445LED4	90		
IN51362	119	IN60362	120	PD0374LED4	97	PLO446LED3	90		
IN51363	119	IN60363	120	PD0376LED3	96	PLO446LED4	90		
IN51364	119	IN60364	120	PD0376LED4	96	PLO447LED3	90		
IN55501	118	IN60521	122	PD0377LED3	96	PLO447LED4	90		
IN55521	118	IN60531	122	PD0377LED4	96	PLO450LED3	84		
IN55522	118	IN60541	122	PD0378LED3	96	PLO450LED4	84		
IN55523	118	IN60551	122	PD0378LED4	96	PLO455LED3	84		
IN55524	118	IN60561	122	PL0121LED3	12	PLO455LED4	84		
IN55531	118	IN61301	120	PL0121LED4	12	PLO460LED3	85		
IN55532	118	IN61341	120	PL0122LED3	12	PLO460LED4	85		
IN55533	118	IN61342	120	PL0122LED4	12	PLO465LED3	85		
IN55534	118	IN61343	120	PL0123LED3	12	PLO465LED4	85		
IN55541	118	IN61344	120	PL0123LED4	12	SN10120	130		
IN55542	118	IN61351	120	PL0124LED3	12	SN10121	130		
IN55543	118	IN61352	120	PL0124LED4	12	SN10122	130		
IN55544	118	IN61353	120	PL0126LED3	11	SN10123	130		
IN55551	118	IN61354	120	PL0126LED4	11	SN10124	130		
IN55552	118	IN65002	116	PL0127LED3	11	SN10125	130		
IN55553	118	IN65003	116	PL0127LED4	11	SN10126	130		
IN55554	118	IN65022	116	PL0128LED3	11	SN10127	130		
IN55561	118	IN65023	116	PL0128LED4	11	SN10128	130		
IN55562	118	IN65032	116	PL0129LED3	11	SN10129	130		
IN55563	118	IN65033	116	PL0129LED4	11	SN10140	131		
IN55564	118	IN65042	116	PL02002LED3	38	SN10141	131		
IN55625	128	IN65043	116	PL02002LED4	38	SN10142	131		
IN55626	129	IN65100	116	PL02003LED3	38	SN10143	131		
IN55627	129	IN65104	116	PL02003LED4	38	SN10144	131		
IN55635	128	IN65106	116	PL02004LED3	34	SN10145	131		
IN55636	129	IN65107	116	PL02004LED4	34	SN10150	56		
IN55637	129	IN65124	116	PL02005LED3	34	SN10151	56		
IN55645	128	IN65134	116	PL02005LED4	34	SN10152	56		
IN55646	129	IN65144	116	PL03006	92	SN10153	56		
IN55647	129	IN8000/2	107	PL03009	88	SN10154	57		
IN55655	128	IN8001	107	PL03010	88	SN10155	57		
IN55665	128	IN8002	107	PL03011	88	SN10156	57		
IN55925	126	IN8003	107	PL03020	93	SN10180	65		
IN55935	126	IN8007	108	PL03021	93	SN10181	65		
IN55945	126	IN8008	108	PL03022	93	SNT022LED1	133		





**Catálogo de produtos Newline.**

Imagens meramente ilustrativas.

A NewLine Iluminação reserva-se ao direito de alterar toda e qualquer informação deste catálogo sem prévio aviso.

*Be Light!*

