

NEW

COLLECTIONS
2022



Be Light!

Ícone no mercado brasileiro de iluminação, referência de design e qualidade, a marca Studiolute sempre foi sinônimo de excelência, desenvolvendo produtos equiparados aos das melhores indústrias internacionais.

Hoje, acreditamos ser possível se inspirar nessa história de sucesso para oferecer aos apaixonados por iluminação um renovado e inovador mix de produtos. Prazer, nós somos a Studiolute!

Coleções



Valley
pág. 12



Tarta
pág. 14



Land
pág. 15



Dock
pág. 16



Toak
pág. 18



Hort
pág. 19



Shell
pág. 20



Tazza
pág. 21



Ricci
pág. 22



Balka
pág. 24



Haken
pág. 25



Netz
pág. 26



Lance
pág. 27



Lorum
pág. 28



Antik
pág. 30



Versa
pág. 32



Zenit
pág. 34



Atenas
pág. 36



Aura
pág. 38



Crown
pág. 39



Twist
pág. 40



Blade
pág. 42



Blade
pág. 44



Cissy
pág. 46



Cissy
pág. 48



Cissy
pág. 50



Sophi
pág. 52



Zione
pág. 54



Zione
pág. 56



Zione
pág. 58



Zione
pág. 60



Zione
pág. 62



Zavo
pág. 64



Lune
pág. 66



Orec
pág. 70



Cloud
pág. 71



Cloud II
pág. 72



Moon
pág. 74



Moon
pág. 76



Moon
pág. 78



Full Moon
pág. 80



Plyn
pág. 82



Colli
pág. 86



Lolly
pág. 90



Lolly
pág. 92



Laticius
pág. 94



Lactite
pág. 98



Lactite
pág. 100



Lynus
pág. 102



Maya
pág. 104



Maya
pág. 106



Blur
pág. 108



Diamond
pág. 110



Diamond
pág. 112



Petram
pág. 114



Castillo
pág. 116



Suez
pág. 118



Suez
pág. 120



Suez
pág. 122



Suez
pág. 124

Coleções



Suez
pág. 126



Suez
pág. 128



Suez
pág. 130



Anello
pág. 132



Anello
pág. 134



Anello Oval
pág. 136



Pectus
pág. 138



Horizon
pág. 140



Eclipse
pág. 142



Drain
pág. 144



Drain
pág. 146



Drain Office
pág. 150



Bases Abajur
pág. 154



Bases Abajur
pág. 156



Bases Abajur
pág. 158



Bases Abajur
pág. 160



Cúpulas Abajur
pág. 162



Canopla Slim para Gesso
pág. 164



Volpi
pág. 166



Jadore
pág. 167



Wala
pág. 168



Allure
pág. 170



Fusion
pág. 172



Ritz
pág. 173



Avis
pág. 174



Kira
pág. 176



Asha
pág. 177



Calla
pág. 178



Somut
pág. 180



Dover
pág. 182



Sonik
pág. 183



Spy
pág. 184



Hazel
pág. 186



Horus
pág. 187



Berla
pág. 188



Space
pág. 190



Lamu
pág. 192



Ludo
pág. 193



Pinot
pág. 194



Bert
pág. 198



Mob
pág. 199



Dupe
pág. 200



Luft
pág. 201



Kane
pág. 202



Vermont
pág. 204



Eden
pág. 205



Tera
pág. 206



Ohana
pág. 207



Luxor
pág. 208



Blasen
pág. 209



Linse
pág. 210



Augen
pág. 211



Gali
pág. 212



Orbit Mondri
pág. 214



Orbit Mondri
pág. 216



Orbit Mondri
pág. 218



Orbit Mondri
pág. 220



Orbit Mondri
pág. 222



Orbit Mondri
pág. 223



Orbit Mondri
pág. 224



Orbit Mondri
pág. 226



Orbit
pág. 228



Orbit
pág. 229



Orbit
pág. 230



Orbit
pág. 232



Orbit
pág. 234

Coleções



Orbit
pág. 236



Orbit
pág. 237



Orbit
pág. 238



Orbit
pág. 239



Orbit II
pág. 240



Orbit II
pág. 242



Orbit II
pág. 243



Orbit II
pág. 244



Orbit II
pág. 246



Orbit II
pág. 248



Orbit II
pág. 250



Orbit II
pág. 251



Orbit II
pág. 252



Sierra
pág. 254



Zaz
pág. 256



Zaz
pág. 258



Hook
pág. 260



Hook
pág. 261



Hook
pág. 262



Hook
pág. 264



Hook
pág. 265



Hook
pág. 266



Hook
pág. 267



Hook
pág. 268



Cadre
pág. 270



Cadre
pág. 272



Cadre
pág. 273



Cadre
pág. 274



Mini Moon
pág. 276



Sears
pág. 278



Sears
pág. 280



Trento
pág. 282



Trento
pág. 284



Deuce
pág. 286



Neolus
pág. 288



Hunt
pág. 290

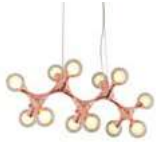

DNA
pág. 291



Atomy
pág. 292



Biene
pág. 294



Link
pág. 296



Cosmos
pág. 298



Belle
pág. 300

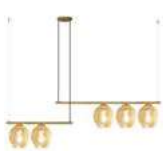

Ravelo
pág. 301



Torchia
pág. 302



Cutie
pág. 304



Jetty
pág. 306



Cálico
pág. 307



Sion
pág. 308



Hilton
pág. 309



Triplet
pág. 310



Bead
pág. 312



Flint
pág. 314



Spire
pág. 315



Pellet
pág. 316



Classic
pág. 317



Drip
pág. 318



Clam
pág. 319



Tear
pág. 320



Spring
pág. 321



Dublin
pág. 322



Rafik
pág. 324



Rafik
pág. 325



Rafik
pág. 327



Tagne
pág. 330

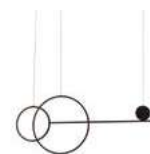

Mallen
pág. 331



Orgon
pág. 332

Coleções



Lace
pág. 334



Worm
pág. 335

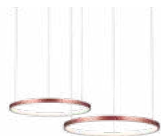

Quebec
pág. 336



Quebec
pág. 338



Montreal
pág. 340



Montreal
pág. 342



Hoop
pág. 344



Twine
pág. 345



Roof
pág. 346



Haus
pág. 347



Cozy
pág. 348



Vision
pág. 349



Pipe
pág. 350



Aniko
pág. 351



Post
pág. 352



Dome
pág. 353



Spine
pág. 354



Arrow
pág. 356



Cannon
pág. 357



Cluster
pág. 358



Torch
pág. 360



Trace
pág. 361



Kiev
pág. 362



Globe
pág. 364



Manner
pág. 365



Tine
pág. 366



Ivory
pág. 368



Mystic
pág. 369



Nice
pág. 370



Lockup
pág. 371



Jubile
pág. 372



Sling
pág. 373



Cover
pág. 374



Halter
pág. 375



Askin
pág. 376



Beaver
pág. 378



Bergen
pág. 380



Bergen
pág. 381



Vega
pág. 382



Hamar
pág. 383



Helmet
pág. 384



Brande
pág. 385



Horn
pág. 386



Horn
pág. 387



Horn
pág. 388



Horn
pág. 390



Nexus
pág. 391



Kono
pág. 392



Orla
pág. 393



Mizo
pág. 394



Krio
pág. 395



Potter
pág. 396



Milão
pág. 398



Verona
pág. 399



Sicília
pág. 400



Turret
pág. 401



Tack
pág. 402



Tint
pág. 403



Magnetic System
pág. 404

Valley

LANÇAMENTO 2022

Estrutura: Alumínio
Acabamento: Preto ou Branco



- PD1692BR
 - PD1692PT
- Pendente

LED 40W
Lúmens: 1800lm
Temperatura: 3000K
Dimensões: Ø800 x A43 mm
Tensão: Bivolt (127V/220V)
Potência máxima: 40W
Cabo ajustável até 1500mm



- PD1691BR
 - PD1691PT
- Pendente

LED 34W
Lúmens: 1530lm
Temperatura: 3000K
Dimensões: Ø600 x A43 mm
Tensão: Bivolt (127V/220V)
Potência máxima: 34W
Cabo ajustável até 1500mm

COM EFEITO
DE LUZ
**DIRETA E
INDIRETA**

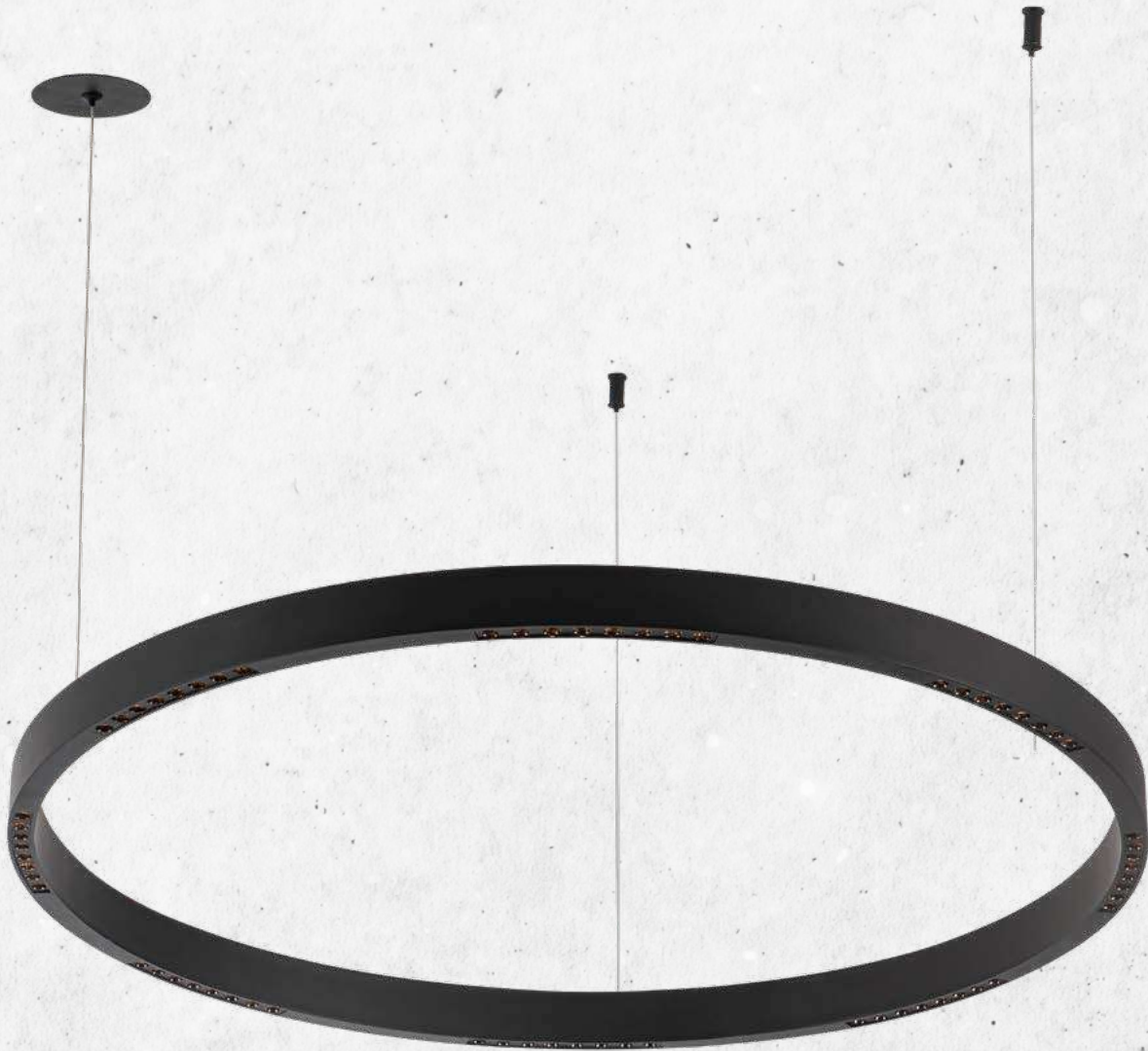

PD1692PT

Tarta

LANÇAMENTO 2022

Estrutura: Metal / Vidro
Acabamento: Dourado fosco



● **PD1728**

Pendente

1xG9 Halopin LED 5W
Dimensões: Ø800 x A460 mm
Tensão: Bivolt (127V/220V)
Potência máxima: 5W
Cabo ajustável até 2000mm

Land

LANÇAMENTO 2022

Estrutura: Metal / Vidro
Acabamento: Preto cromado



● **PD1729**

Pendente

LED 44W

Lúmens: 2640lm

Temperatura: 3000K

Dimensões: Ø700 x A150 mm

Tensão: Bivolt (127V/220V)

Potência máxima: 44W

Cabo ajustável até 2000mm

Dock

LANÇAMENTO 2022

Estrutura: Metal/Sílica gel
Difusor: Tubo em sílica gel opalino
Acabamento: Dourado



Difusor
em material
flexível
- Sílica gel -

● PD1746

Pendente

LED 10W
Lúmens: 700lm
Temperatura: 3000K
Dimensões: C840 x L22 x A620 mm
Tensão: Bivolt (127V/220V)
Potência máxima: 10W



● PD1747

Pendente

LED 15W
Lúmens: 1050lm
Temperatura: 3000K
Dimensões: C1100 x L22 x A800 mm
Tensão: Bivolt (127V/220V)
Potência máxima: 15W



PD1646 / PD1647

Toak

LANÇAMENTO 2022

Estrutura: Metal/Vidro

Difusor:

Acabamento: Dourado



Detalhe do vidro



● **PD1731**

Pendente

10xG9 LED 5W

Dimensões: C1000 x L380 x P230 mm

Tensão: Bivolt (127V/220V)

Potência máxima: 50W



Hort

Estrutura: Metal / Vidro

Acabamento: Dourado escovado

LANÇAMENTO 2022



PD1733



● **PD1732**
Pendente

LED 38W
Lúmens: 2280lm
Temperatura: 3000K
Dimensões: Ø600 x A245 mm
Tensão: Bivolt (127V/220V)
Potência máxima: 37W
Cabo ajustável até 2000mm



● **PD1733**
Pendente

LED 60W
Lúmens: 3600lm
Temperatura: 3000K
Dimensões: Ø1000 x A245 mm
Tensão: Bivolt (127V/220V)
Potência máxima: 60W
Cabo ajustável até 2000mm

Shell

LANÇAMENTO 2022

Estrutura: Metal / Vidro
Acabamento: Dourado



Detalhe do vidro



AR1696

Arandela

3x G9 HALLOPIN LED 5W
Dimensões: C1200 x L150 x A150 mm
Tensão: Bivolt (127V/220V)
Potência máxima: 15W



PD1697

Pendente

21x G9 HALLOPIN LED 5W
Dimensões: Ø750 x A330 mm
Tensão: Bivolt (127V/220V)
Potência máxima: 105W
Cabo ajustável até 2000mm



PD1698

Pendente

10x G9 HALLOPIN LED 5W
Dimensões: C1200 x L150 x A150 mm
Tensão: Bivolt (127V/220V)
Potência máxima: 50W
Cabo ajustável até 2000mm

Tazza

LANÇAMENTO 2022

Estrutura: Metal / Vidro
Difusor: Vidro branco
Acabamento: Dourado



● **PD1707**
Pendente

14x G9 Hallopin LED 5w
Dimensões: C1500 x L415 x A540 mm
Tensão: Bivolt (127V/220V)
Potência máxima: 70W
Cabo 2000mm



Ricci

LANÇAMENTO 2022

Estrutura: Metal / Vidro

Difusor: Vidro champagne e transparente

Acabamento: Dourado



Detalhe do vidro



● **PD1616**

Pendente

15x G9 Hallopin LED 5w
Dimensões: Ø820 x A1660 mm
Tensão: Bivolt (127V/220V)
Potência máxima: 75W
Cabo 1500mm





Balka

LANÇAMENTO 2022

Estrutura: Metal / Vidro
Difusor: Vidro fosco
Acabamento: Branco ou Dourado



- PD1712BR
 - PD1712DO
- Pendente

40x G9 Hallopin LED 5w
Dimensões: Ø1000 x A480 mm
Tensão: Bivolt (127V/220V)
Potência máxima: 200W
Cabo 1500mm

Haken

LANÇAMENTO 2022

Estrutura: Metal

Difusor: Cristal de rocha / Acrílico

Acabamento: Dourado ou Preto (onix)



Cristais de rocha



Difusor em acrílico



PD17130X

● PD1713D0

● PD17130X

Pendente

LED 30W

Lúmens: 1800lm

Temperatura: 3000K

Dimensões: C1500 x L80 x A345 mm

Tensão: Bivolt (127V/220V)

Potência máxima: 30W

Cabo ajustável até 2000mm



Netz

LANÇAMENTO 2022

Estrutura: Metal/ Vidro / Couro sintético

Difusor: Vidro transparente/fosco

Acabamento: Preto



● PD1737

Pendente

LED 21W

Lúmens: 2800lm

Potência: 3000k

Dimensões: C2500 x A900 mm

Tensão: Bivolt (127V/220V)

Potência máxima: 21W



Lance

LANÇAMENTO 2022

Estrutura: Metal/ Silicone

Difusor: Silica gel

Acabamento: Preto



● PD1739

Pendente

LED 40W

Lúmens: 2800lm

Potência: 3000k

Dimensões: C2000 x A600 mm

Tensão: Bivolt (127V/220V)

Potência máxima: 40W

Difusor
em material
flexível
- Silica gel -

Lorum

LANÇAMENTO 2022

Estrutura: Metal/ Vidro / Couro sintético

Difusor: Acrílico

Acabamento: Preto



● **PD1738**

Pendente

LED 13W + 15w

Lúmens: 1960lm

Potência: 3000k

Dimensões: C470+450 x A1300 + 1500 mm

Tensão: Bivolt (127V/220V)

Potência máxima: 28W



Antik

LANÇAMENTO 2022

Estrutura: Metal/ Vidro
Difusor: Vidro fosco
Acabamento: Dourado



● AR1717DO

Arandela

1x G9 5W

Dimensões: L100 x P230 x A280 mm

Tensão: Bivolt (127V/220V)

Potência máxima: 5W



● AR1718DO

Arandela

2x G9 5W

Dimensões: L230 x P260 x A280 mm

Tensão: Bivolt (127V/220V)

Potência máxima: 10W



PD1733



● **PD1716DO**

Pendente

8x G9 5W

Dimensões: 790 x L340 x A340 mm

Tensão: Bivolt (127V/220V)

Potência máxima: 40W

Cabo ajustável até 2000mm

Versa

LANÇAMENTO 2022

Estrutura: Aço inox

Difusor: Sílica gel branco

Acabamento: Dourado ou Preto (onix)



● PD1708DO

● PD1708OX

Pendente

LED 91W

Lúmens: 63701lm

Temperatura: 2900K

Dimensões: C1550 x L330 x A360 mm

Tensão: Bivolt (127V/220V)

Potência máxima: 91W

Cabo 1500mm



Zenet

LANÇAMENTO 2022

Estrutura: Metal/ Cristal
Difusor: Cristal
Acabamento: Dourado ou Preto

● PD1650DO Pendente

LED 23W
Lúmens: 1840lm
Temperatura: 3000K
Dimensões: C1200 x L36 x A76 mm
Tensão: Bivolt (127V/220V)
Potência máxima: 23W
Cabo ajustável até 1500mm

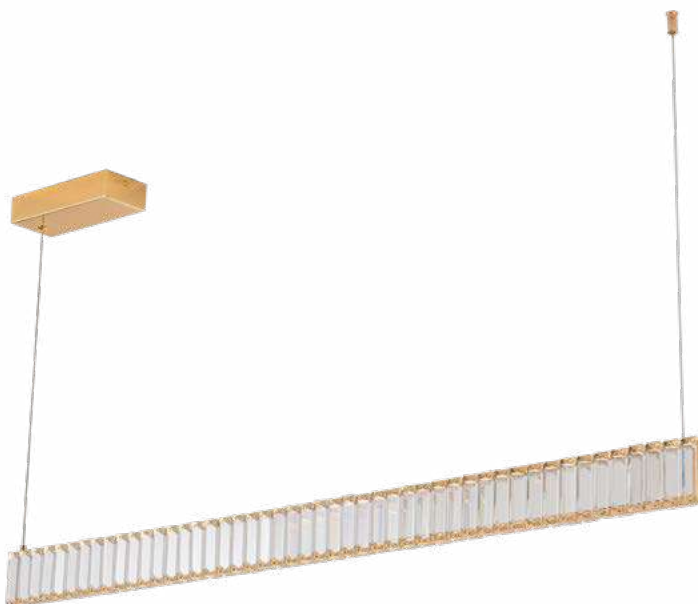

● PD1651DO Pendente

LED 60W
Lúmens: 4800lm
Temperatura: 3000K
Dimensões: C1200 x L250 x A76 mm
Tensão: Bivolt (127V/220V)
Potência máxima: 23W
Cabo ajustável até 1500mm





PD1651DO

Atenas

LANÇAMENTO 2022

Estrutura: Metal/ Acrílico
Difusor: Acrílico
Acabamento: Dourado



● PD1764 Pendente

LED 28W
Lúmens: 1468lm
Temperatura: 3000K
Dimensões: C1000 x L295 x A150 mm
Tensão: Bivolt (127V/220V)
Potência máxima: 28W
Cabo ajustável até 3000mm



● PD1765 Pendente

LED 37W
Lúmens: 1762lm
Temperatura: 3000K
Dimensões: C1500 x L435 x A150 mm
Tensão: Bivolt (127V/220V)
Potência máxima: 37W
Cabo ajustável até 3000mm



PD1765

Aura

LANÇAMENTO 2022

Estrutura: Metal / Vidro
Difusor: Champagne
Acabamento: Dourado



● **PD1615**
Pendente

24xG9 Hallopin LED 5W
Dimensões: Ø1250 x A250 mm
Tensão: Bivolt (127V/220V)
Potência máxima: 75W
Cabo 1500mm



● **PD1614**
Pendente

15xG9 Hallopin LED 5W
Dimensões: Ø900 x A250 mm
Tensão: Bivolt (127V/220V)
Potência máxima: 75W
Cabo 1500mm

Crown

LANÇAMENTO 2022

Estrutura: Metal / Alumínio

Difusor: Acrílico

Acabamento: Dourado

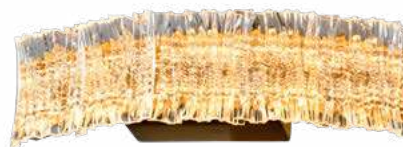

● AR1709

Arandela

LED 9W
Lúmens: 6301lm
Temperatura: 3000K
Dimensões: C260 x A70 mm
Tensão: Bivolt (127V/220V)
Potência máxima: 9W



● PL1710

Plafon

LED 62W
Lúmens: 4340lm
Temperatura: 3000K
Dimensões: Ø630 x A70 mm
Tensão: Bivolt (127V/220V)
Potência máxima: 62W

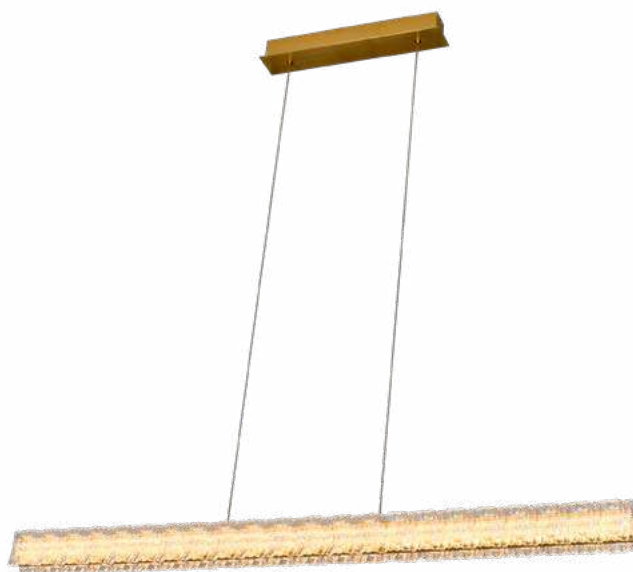

● PD1711

Pendente

LED 85W
Lúmens: 59501lm
Temperatura: 3000K
Dimensões: C1200 x L60 x A70 mm
Tensão: Bivolt (127V/220V)
Potência máxima: 85W
Cabo 1500mm

Twist

LANÇAMENTO 2022

Estrutura: Metal / Acrílico
Acabamento: Dourado



● **PD1734**
Pendente

LED 75W
Lúmens: 5250lm
Temperatura: 3000K
Dimensões: Ø650 x A113 mm
Tensão: Bivolt (127V/220V)
Potência máxima: 75W



Blade

NOVO
ACABAMENTO
DOURADO

Estrutura: Metal

Difusor: Acrílico com efeito degradê
(fosco/cristal)

Acabamento: Dourado ou preto



● PD1501ADO

● PD1501A

Pendente

10L / 40W / 2400lm / 3000k

Dim.: Ø700 x A370 mm

Tensão: Bivolt (127V/220V)

Cabo ajustável até 2 m

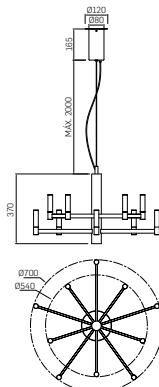

Novo
difusor de
**ACRÍLICO
DEGRADÊ**



PD1502ADO



● PD1502ADO

● PD1502A

Pendente

16L / 57W / 3420lm / 3000k
 Dimensões: Ø840 x A485 mm
 Tensão: Bivolt (127V/220V)
 Cabo ajustável até 2 m

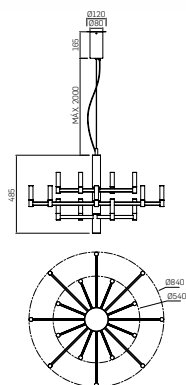

Novo
 difusor de
**ACRÍLICO
 DEGRADÊ**

Blade

Estrutura: Metal

Difusor: Acrílico com efeito degradê
(fosco/cristal)

Acabamento: Dourado ou preto



NOVO
ACABAMENTO
DOURADO



● **AR1500ADO**

● **AR1500A**

Pendente

3W / 180lm / 3000K

Dimensões: C50 x L90 x A155 mm

Tensão: Bivolt (127V/220V)

Potência máxima: 3W

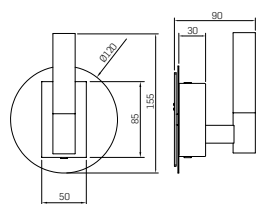

Novo
difusor de
**ACRÍLICO
DEGRADÊ**

NOVO
ACABAMENTO
DOURADO



Novo
difusor de
**ACRÍLICO
DEGRADÊ**



- **PD1503ADO**
 - **PD1503A**
- Pendente

10L / 57W / 3420lm / 3000K
Dimensões: C1100 x A140 mm
Tensão: Bivolt (127V/220V)
Cabo ajustável até 2 m

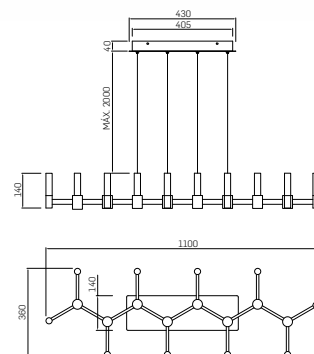

Cissy

Estrutura: Metal

Difusor: Acrílico com efeito degradê
(fosco/cristal)

Acabamento: Dourado ou preto



● **PD1509**
Pendente

8L / 30W / 1800 lm / 3000k
Dimensões: Ø750 x A500 mm
Tensão: Bivolt (127V/220V)
Cabo ajustável até 2 m

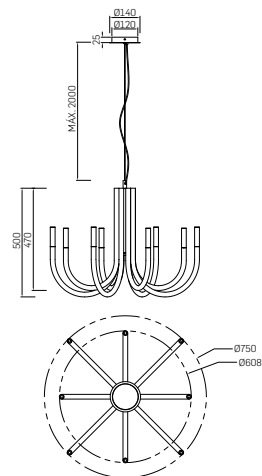

● **PD1510**
Pendente

15L / 59W / 3540lm / 3000k
Dimensões: Ø850 x A595 mm
Tensão: Bivolt (127V/220V)
Cabo ajustável até 2 m

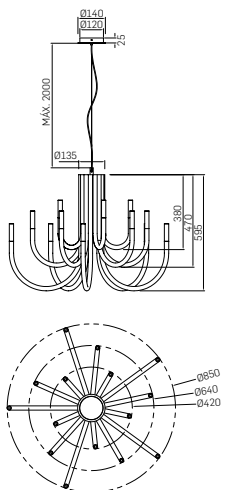

PD1510



PD1642DO



● PD1642DO

● PD1642PT

Pendente

5L / 15W / 900lm / 3000k

Dimensões: L1200 x A400 x P490 mm

Tensão: Bivolt (127V/220V)

Cabo ajustável até 2 m

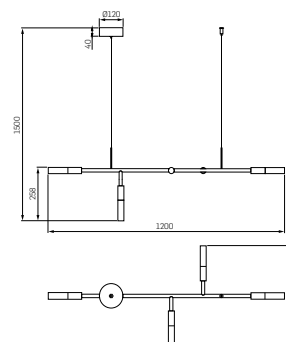

LANÇAMENTO 2022

Cissy

Estrutura: Metal

Difusor: Acrílico com efeito degradê
(fosco/cristal)

Acabamento: Dourado ou preto



● PD1508DO

● PD1508PT

Pendente

3W / 180lm / 3000k

Dimensões: Ø30 x A360 mm

Tensão: Bivolt (127V/220V)

Cabo ajustável até 2 m



PD1508DO



PD1508DO / PD1508PT
Compatíveis com
canopla para gesso
(vendida separadamente)



● **AR1722**
Arandela

LED 3W
Lúmens: 180lm
Temperatura: 3000K
Dimensões: L120x P190 x A3200 mm
Tensão: Bivolt (127V/220V)
Potência máxima: 3W

LANÇAMENTO 2022

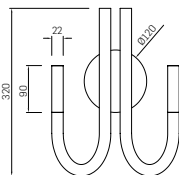

● **AR1507**
Arandela

10W / 600 lm / 3000k
Dimensões: C245 x L170 x A320 mm
Tensão: Bivolt (127V/220V)

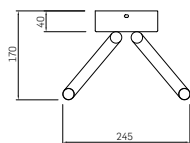

Cissy

Estrutura: Metal

Difusor: Acrílico com efeito degradê
(fosco/cristal)

Acabamento: Dourado ou preto

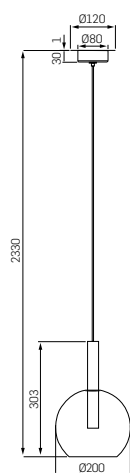

● PD1484DO

● PD1484PT

Pendente

3W / 180lm / 3000k
Dimensões: Ø200 x A300 mm
Tensão: Bivolt (127V/220V)
Cabo ajustável até 2 m





PD1484D0

Sophi

Estrutura: Metal e vidro
Bobechas: Vidro
Acabamento: Bronze e preto

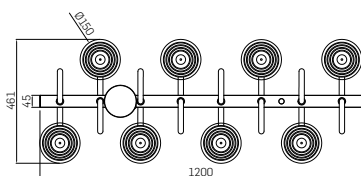
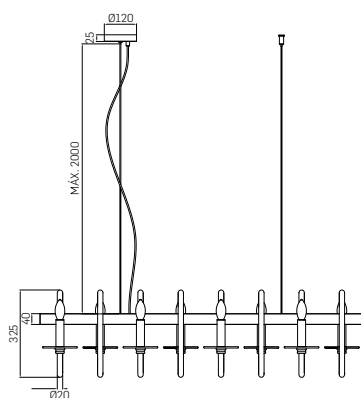
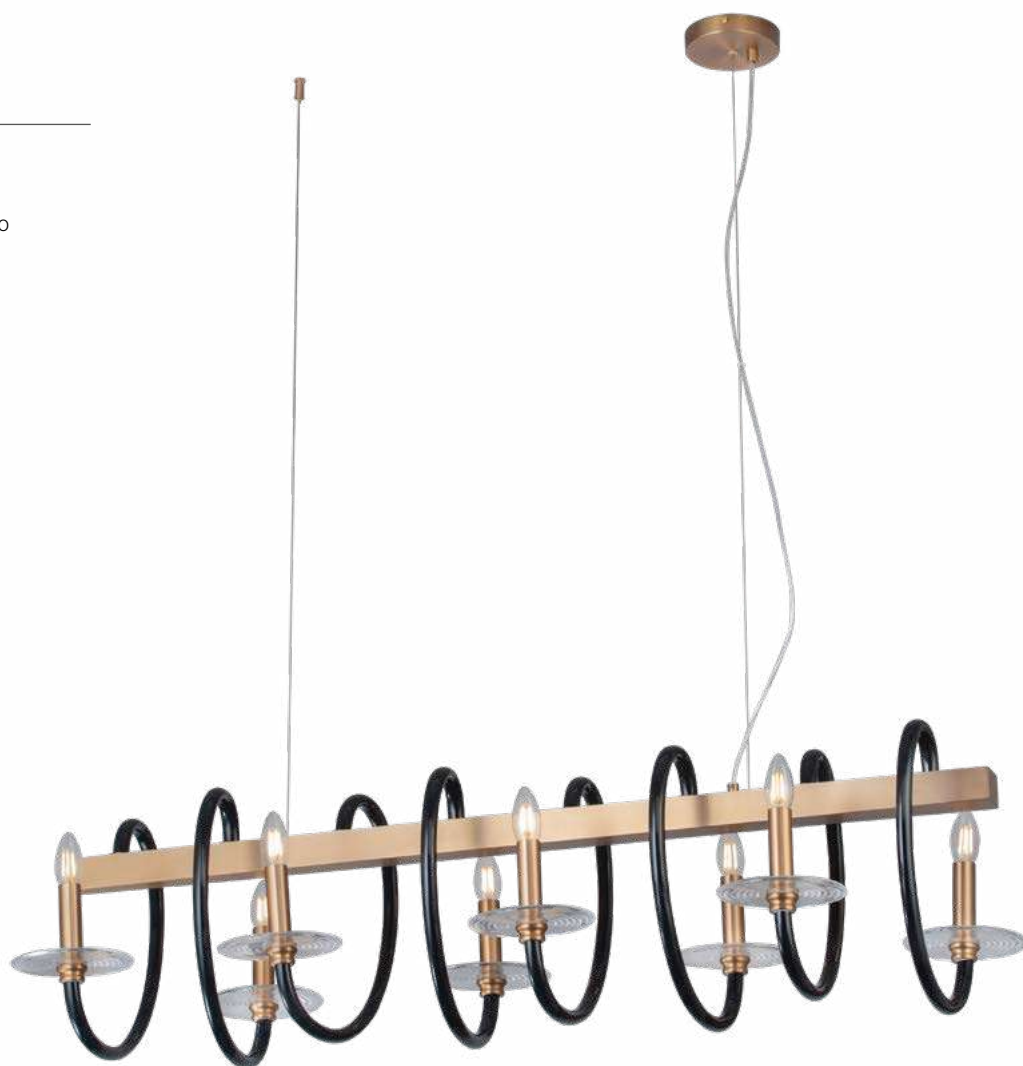

● PD1512

Pendente

8xE14 / 40W
Dim.: C1200 x L461 x A325 mm
Tensão: Bivolt (127V/220V)
Cabo ajustável até 2 m



● **AR1511**
Arandela

1xE14 / 40W
Dim.: C357 x L120 x A321 mm
Tensão: Bivolt (127V/220V)

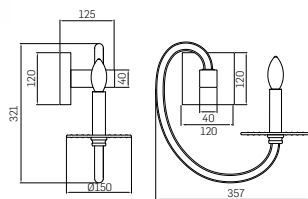

Zione

LANÇAMENTO 2022

Estrutura: Metal

Difusor: Acrílico

Acabamento: Dourado ou preto



● **AR1647DO**

● **AR1647PT**

Arandela

LED 3W

Lúmens: 240lm

Temperatura: 3000K

Dimensões: L30 x P48 x A145 mm

Tensão: Bivolt (127V/220V)

Potência máxima: 3W



● **AR1646DO**

● **AR1646PT**

Arandela

LED 2x3W

Lúmens: 480lm

Temperatura: 3000K

Dimensões: L30 x P48 x A250 mm

Tensão: Bivolt (127V/220V)

Potência máxima: 6W



AR1646PT

Zione

Estrutura: Metal

Difusor: Acrílico

Acabamento: Dourado ou preto



Pendente articulável



● PD1488DO

● PD1488PT

Pendente

LED 1x3W / 240 lm / 3000k

Dim.: Ø35 x A380 mm

Tensão: Bivolt (127V/220V)

Cabo ajustável até 1,50 m

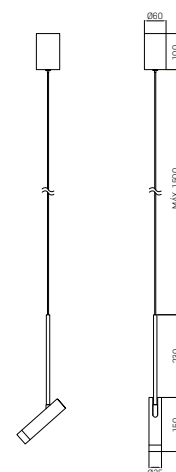

● PD1491DO

● PD1491

Pendente

LED 6x3W / 1440 lm / 3000k

Dim.: C1100 x A145 mm

Tensão: Bivolt (127V/220V)

Cabo ajustável até 1,50 m

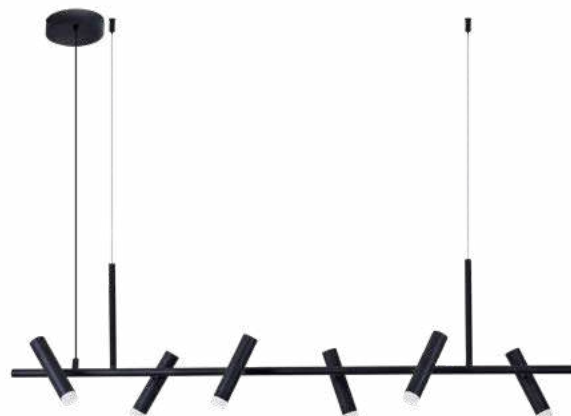
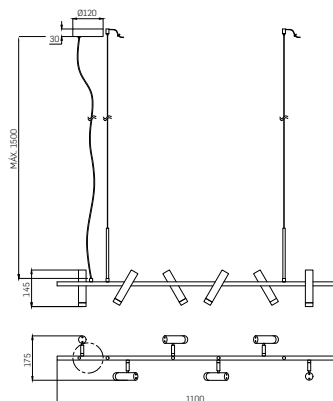



PD1488PT



PD1488DO / PD1488PT
Compatíveis com
canopla para gesso
(vendida separadamente)

Zione

Estrutura: Metal

Difusor: Acrílico

Acabamento: Dourado ou preto

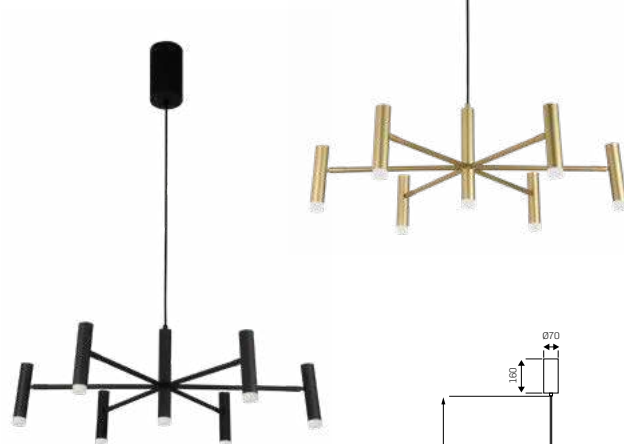

● PD1498DO

● PD1498

Pendente

21W (7x3W) / 1680 lm / 3000k

Dim.: Ø700 x A240 mm

Tensão: Bivolt (127V/220V)

Cabo ajustável até 1,50 m

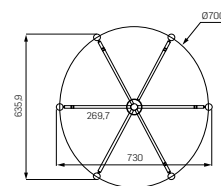
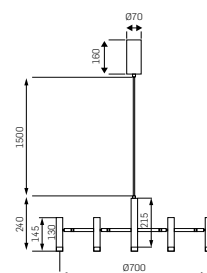

● PD1499DO

● PD1499

Pendente

39W (13x3W) / 3120 lm / 3000k

Dim.: Ø800 x A400 mm

Tensão: Bivolt (127V/220V)

Cabo ajustável até 1,50 m

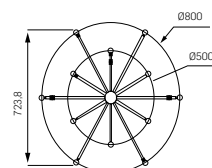
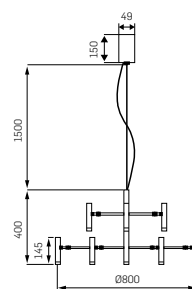



PD1499DO

Zione

Estrutura: Metal

Difusor: Acrílico

Acabamento: Dourado ou preto



Arandela articulável



Com interruptor na base



● **AR1600DO**

● **AR1600**

Arandela

LED 1x3W / 240 lm / 3000k
Dim.: C210 x L120 x A355 mm
Tensão: Bivolt (127V/220V)

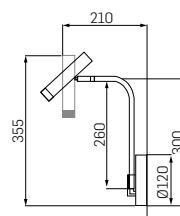

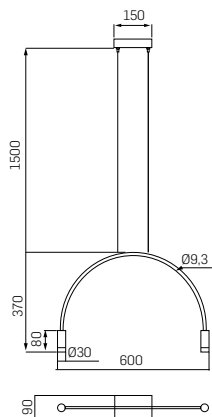
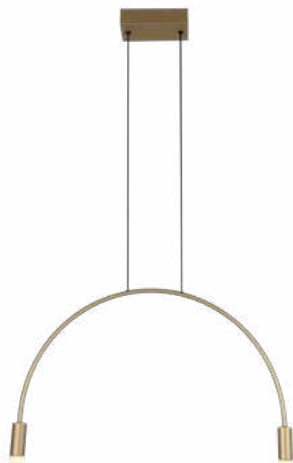
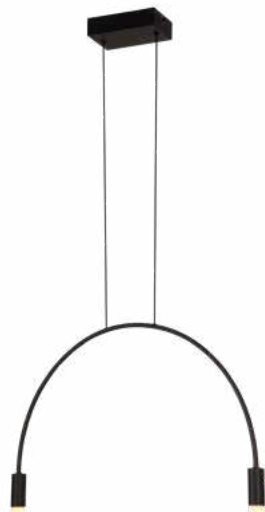

● PD1610DO

● PD1610

Pendente

6W (2x3W) / 480 lm / 3000k
 Dim.: C600 x L30 x A370 mm
 Tensão: Bivolt (127V/220V)
 Cabo ajustável até 1,50 m

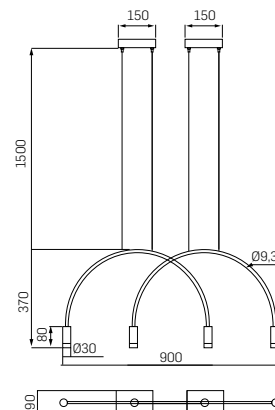
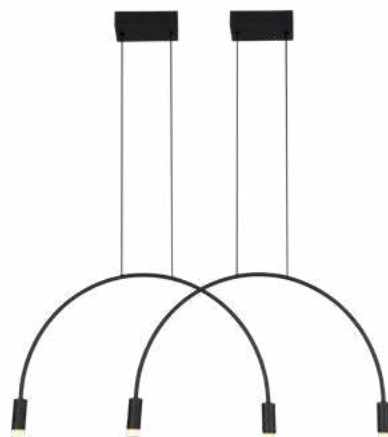

● PD16102DO

● PD16102

Pendente

12W (4x3W) / 960 lm / 3000k
 Dim.: C900 x L30 x A370 mm
 Tensão: Bivolt (127V/220V)
 Cabo ajustável até 1,50 m

Zione

Estrutura: Metal

Difusor: Acrílico

Acabamento: Dourado ou preto



Luminária de mesa e coluna articuláveis



● **LM1601DO**

● **LM1601**

Luminária de mesa

LED 1x3W / 240 lm / 3000k

Dim.: Ø160 x A480 mm

Tensão: Bivolt (127V/220V)

Cabo de 1,50 m

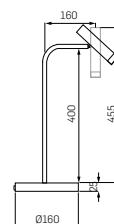

● **LM1489DO**

● **LM1489**

Luminária de mesa

LED 2x3W / 480 lm / 3000k

Dim.: Ø200 x A550 mm

Tensão: Bivolt (127V/220V)

Cabo de 1,50 m

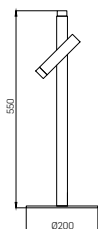

LM1601DO

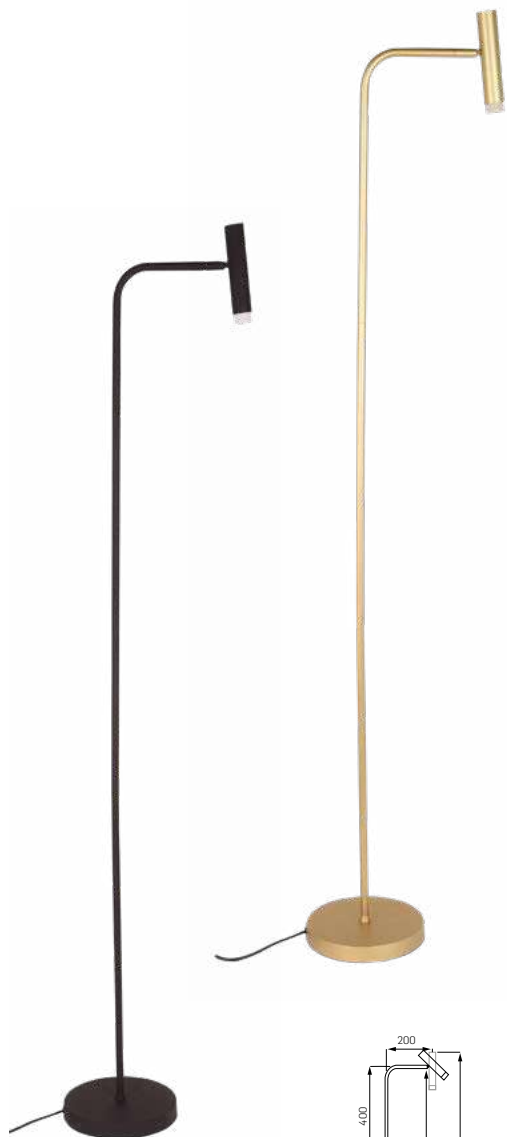

● **CL1602DO**

● **CL1602**

Coluna

LED 1x3W / 240 lm / 3000k

Dim.: Ø200 x A148 mm

Tensão: Bivolt (127V/220V)

Cabo de 1,80 m

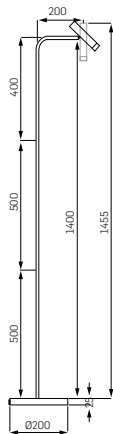

Luminária de mesa e coluna
com dois pontos de luz e
acendimento individual



● **CL1490DO**

● **CL1490**

Coluna

LED 2x3W / 480 lm / 3000k

Dim.: Ø250 x A1655 mm

Tensão: Bivolt (127V/220V)

Cabo de 1,80 m

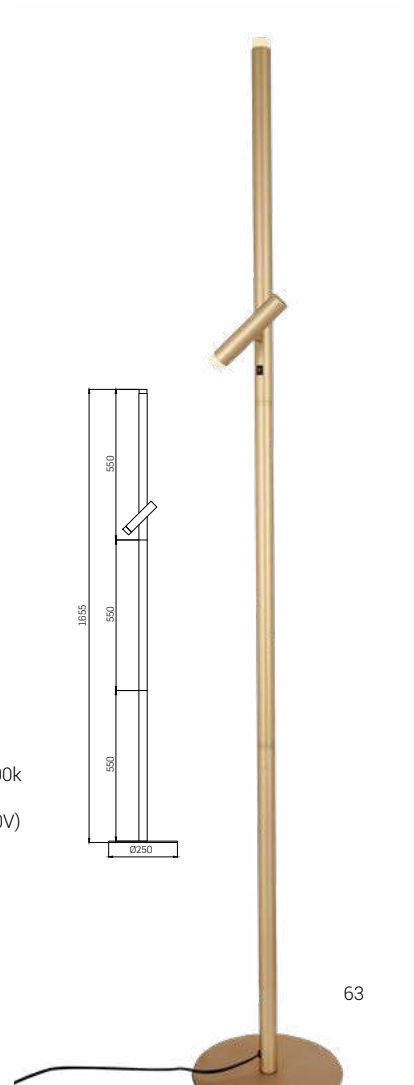
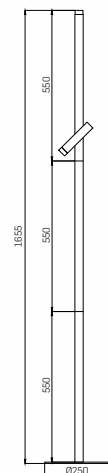

Zavo

Estrutura: Metal

Difusor **PD1492**: Sílica gel (flexível)

Difusor **PD1608/PD1608DO**: Acrílico (rígido)

Difusor **CL1493**: Acrílico (rígido)

Acabamento: Preto ou dourado



Difusor em material flexível
- Sílica gel -

● **PD1492**
Pendente

LED 13W / 760lm / 3000k
Dimensões: C1200 x A56 mm
Tensão: Bivolt (127V/220V)
Cabo ajustável até 1,50 m

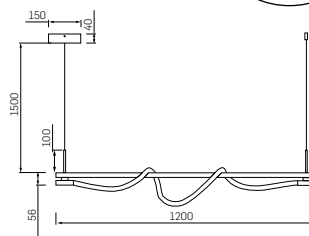

● **PD1608DO**

● **PD1608**
Pendente

LED 30W / 1500lm / 3000k
Dimensões: Ø700 x A20 mm
Tensão: Bivolt (127V/220V)
Cabo ajustável até 1,50 m

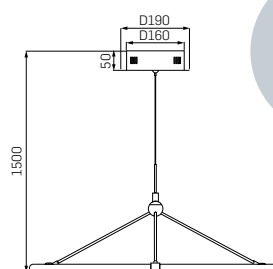

Difusor em material rígido
- Acrílico -



Difusor
em material
rígido
- Acrílico -

● **CL1493**

Coluna

LED 15W / 720lm / 3000k
Dim.: Ø305 x A1500 mm
Tensão: Bivolt (127V/220V)
Cabo de 3,20 m

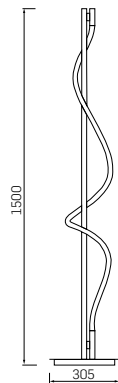

Lune

Estrutura: Metal

Difusor: Vidro canelado transparente e parte interna em vidro opalino

Acabamento: Dourado



● PD1519 Pendente

12V / 2x11W / 1320lm / 3000k
Dimensões: Ø200 x C350 x A2098 mm
Tensão: Bivolt (127V/220V)
Cabo ajustável até 2,10 m

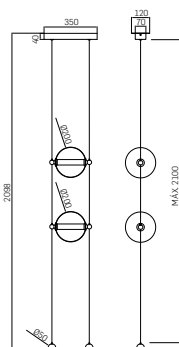

● PD1518 Pendente

12V / 11W / 660 lm / 3000k
Dimensões: Ø200 x C350 x A2098 mm
Tensão: Bivolt (127V/220V)
Cabo ajustável até 2,10 m

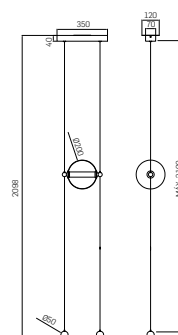

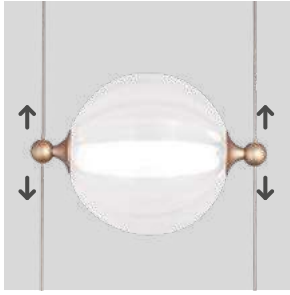

Difusor com posição ajustável através de trava-cabo de fácil manuseio



● **PD1520**
Pendente

12V / 4x10W / 2400lm / 3000k
 Dimensões: Ø200 x C1100 x A2098 mm
 Tensão: Bivolt (127V/220V)
 Cabo ajustável até 2,10 m

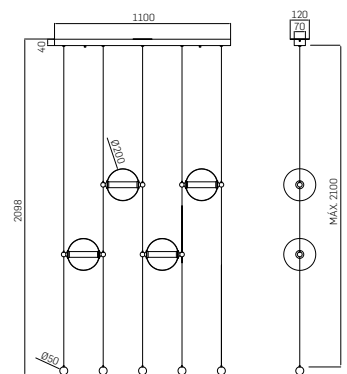



PD1520



PD1518 / PD1519

Orec

Estrutura: Alumínio

Cúpula: Vidro / vidro opalino interno

Acabamento: Cobre ou dourado



● PD1406CO

Pendente

1xE27 40W

Dimensões: Ø400 x A670 mm

Tensão: Bivolt (127V/220V)

Potência máx.: 40W

Cabo ajustável até 1,50 m

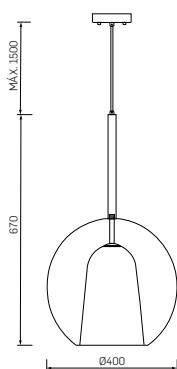

Cloud

Estrutura: Metal e vidro

Difusor: Vidro opalino

Acabamento: Dourado ou preto

Cabo ajustável até 1,50 m

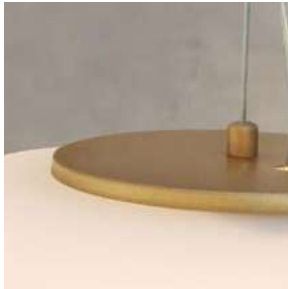

● PD1496DO

● PD1496PT

Pendente

1xE27 / 40W

Dimensões: Ø300 x A260 mm

Tensão: Bivolt (127V/220V)

Potência máx.: 40W

Cabo ajustável até 1,50 m

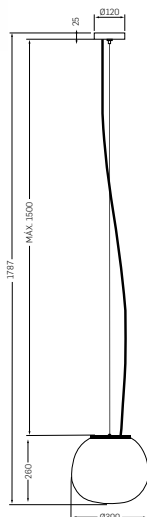

● PD1497DO

● PD1497PT

Pendente

1xE27 / 40W

Dim.: Ø450 x A380 mm

Tensão: Bivolt (127V/220V)

Potência máx.: 40W

Cabo ajustável até 1,50 m

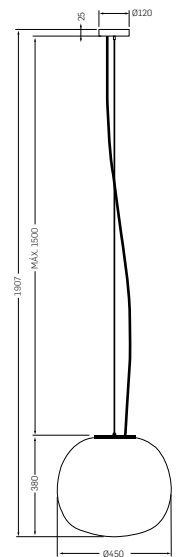

Cloud II

LANÇAMENTO 2022

Estrutura: Metal / Vidro

Difusor: Difusor ambar / difusor interno
branco opalino

Acabamento: Dourado



● **PD1682DO**

Pendente

1xG9 40w
Dimensões: 300 x A315 mm
Tensão: Bivolt (127V/220V)
Potência máxima: 6W
Cabo ajustável 1500mm



● **PD1683DO**

Pendente

1xG9 40w
Dimensões: 450 x A435 mm
Tensão: Bivolt (127V/220V)
Potência máxima: 6W
Cabo ajustável 1500mm





PD1682DO / PD1683DO

Moon

Estrutura: Metal

Difusor: Acrílico

Acabamento: Dourado ou preto



- PD1521DO
 - PD1521PT
 - PD1521BR
- Pendente D

7W / 420lm / 3000k
Dimensões: Ø150 x A2240 mm
Tensão: Bivolt (127V/220V)
Cabo ajustável até 2 m

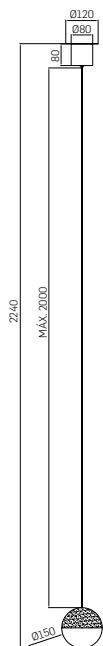

- PD1522DO
 - PD1522PT
 - PD1521BR
- Pendente U

7W / 420lm / 3000k
Dimensões: Ø150 x A2240 mm
Tensão: Bivolt (127V/220V)
Cabo ajustável até 2 m

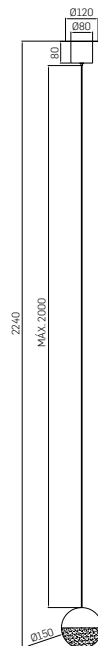



PD1521PT / PD1522PT

Moon

Estrutura: Metal

Difusor: Acrílico

Acabamento: Dourado ou preto



● **PD1641DO**

● **PD1641PT**

Pendente

14W (2x7W) / 840lm / 3000k
Dim.: C1120 x L150 x A375 mm
Tensão: Bivolt (127V/220V)
Cabo ajustável até 2m

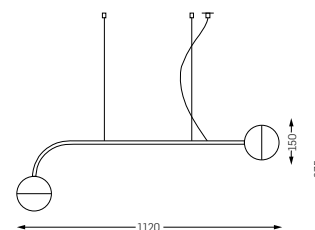

● **AR1640DO**

● **AR1640PT**

Arandela

7W / 420lm / 3000k
Dim.: C175 x L150 x A300 mm
Tensão: Bivolt (127V/220V)

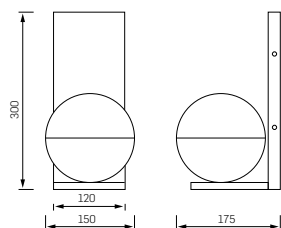



PD1641PT

Moon

LANÇAMENTO 2022

Estrutura: Metal

Difusor: Acrílico

Acabamento: Dourado ou preto



● **AB1720DO**

● **AB1720PT**
Abajur

LED 7W

Lúmens: 420lm

Temperatura: 3000K

Dimensões: 150 x A240 mm

Tensão: Bivolt (127V/220V)

Potência máxima: 7W

Cabo de 1,50 m



AB1720DO

Full Moon

Estrutura: Metal / vidro / acrílico

Difusor: Acrílico

Acabamento: Dourado ou preto

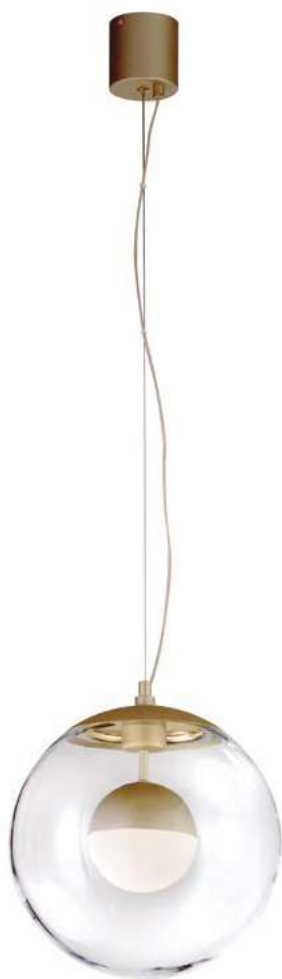

● PD1639DO

● PD1639PT

Pendente

7W / 420lm / 3000k

Dim.: Ø350 x A350 mm

Tensão: Bivolt (127V/220V)

Cabo ajustável até 2m

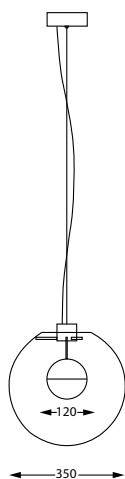



PD1639PT

Plyn

Estrutura: Alumínio
Difusor: Acrílico branco
Acabamento: Dourado



● **AB1422**
Abajur

1xE27 / 40W
Potência máx.: 40W
Dimensões: Ø200 x A250 mm
Tensão: Bivolt (127V/220V)
Cabo de 1,50 m

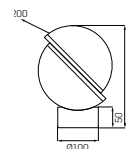

● **AR1421**
Arandela

Cabo dourado
1xG9 (LED) / 5W
Potência máx.: 5W
Dim.: Ø150 x C180 x A310 mm
Tensão: Bivolt (127V/220V)

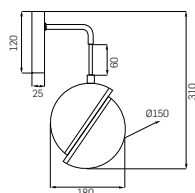



● **PD1420**
Pendente

Cabo dourado
1xE27 / 40W
Potência máx.: 40W
Dimensões: Ø200 x A240 mm
Tensão: Bivolt (127V/220V)
Cabo ajustável até 1,50 m

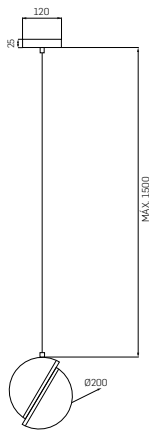



AB1422



Colli

Estrutura: Metal

Difusor: Vidro branco opalino

Acabamento: Dourado ou preto

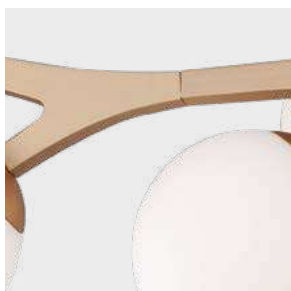

Pendente e plafon com hastes ajustáveis



● **AR1513DO**

● **AR1513PT**

Arandela

2xG9 5W

Potência máxima: 10W

Dimensões: C120 x A673 mm

Difusor: 2xØ150mm

Tensão: Bivolt (127V/220V)

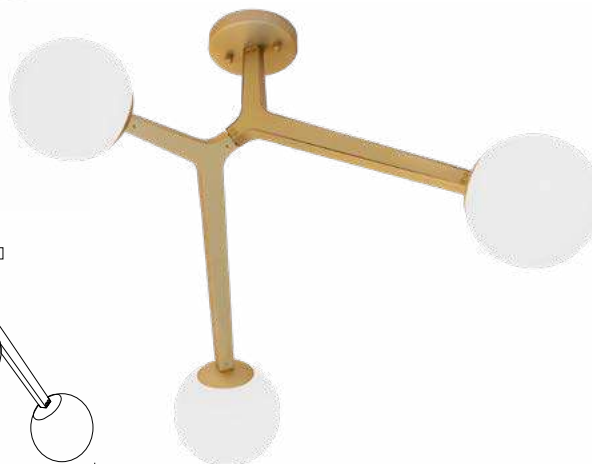
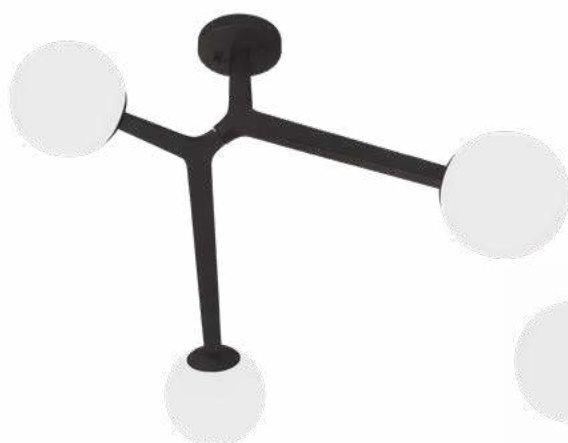
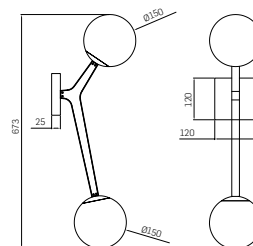

● **PL1609DO**

● **PL1609PT**

Pendente

3xG9 5W

Potência máxima: 15W

Dimensões: L680 x A470 x P560 mm

Tensão: Bivolt (127V/220V)

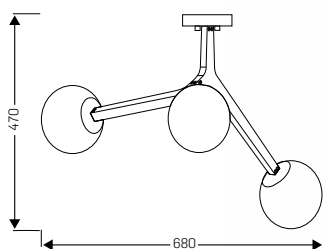



● PD1514DO

● PD1514PT

Pendente

10xG9 5W

Potência máxima: 50W

Dimensões: C1751 x A383 mm

Difusor: 5xØ138 / 5xØ150 mm

Tensão: Bivolt (127V/220V)

Cabo ajustável até 2 m

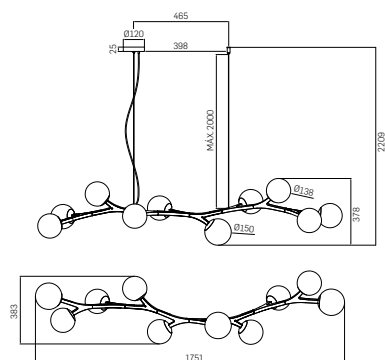



PD1514PT



AR1513DO

Lolly

Estrutura: Metal/alumínio

Cúpula: Vidro branco

Acabamento: Bronze



PD1449

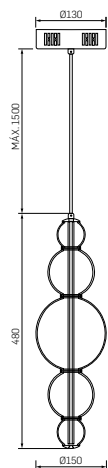

● **PD1448**
Pendente

LED 15W / 1800lm / 3000k
Potência máx.: 15W
Dimensões: Ø150 x A480 mm
Tensão: Bivolt (127V / 220V)
Cabo ajustável até 1,50 m

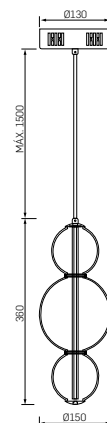

● **PD1449**
Pendente

LED 11W / 1300lm / 3000k
Potência máx.: 11W
Dimensões: Ø150 x A360 mm
Tensão: Bivolt (127V / 220V)
Cabo ajustável até 1,50 m



● **AR1450**
Arandela

LED 11W / 1300lm / 3000k
Potência máx.: 11W
Dim.: Ø150 x L210 x A430 mm
Tensão: Bivolt (127V / 220V)

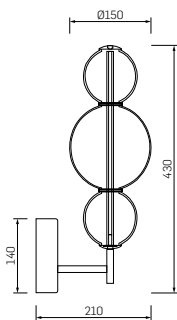

● **PD1451**
Pendente

LED 11W / 1300lm / 3000k
Potência máx.: 11W
Dimensões: Ø100 x A400 mm
Tensão: Bivolt (127V / 220V)
Cabo ajustável até 1,50 m

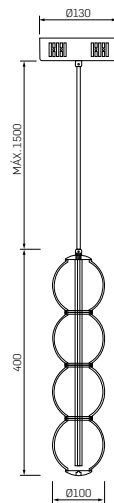

Lolly

Estrutura: Metal/alumínio

Cúpula: Vidro branco

Acabamento: Bronze



● **PD1452**
Pendente

LED 19W / 2100lm / 3000k

Potência máx.: 19W

Dimensões: Ø100 x C600 x A1500 mm

Tensão: Bivolt (127V / 220V)

Cabo ajustável até 1,50 m

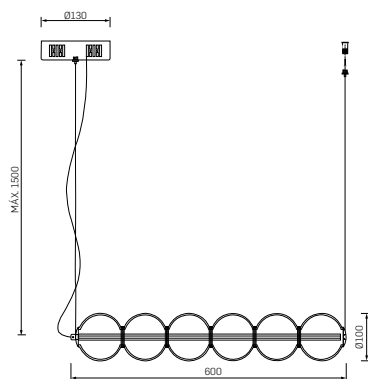



PD1452

Laticius

Estrutura: Metal

Cúpula: Vidro Craquelê ou Vidro branco

Acabamento: Dourado

Disponíveis em duas opções de difusor



Detalhe do vidro



- **PD1407**
Pendente



- **PD1407BR**
Pendente

3xG9 LED 5W
Dim.: C800 x L110 x A230 mm
Tensão: Bivolt (127V / 220V)
Cabo ajustável até 1,50 m

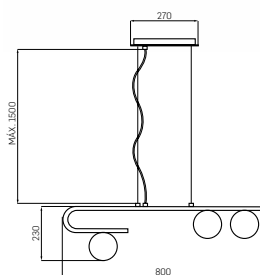



● **AR1409**
Arandela



● **AR1409BR**
Arandela

2xG9 LED 5W
Dim.: C320 x L120 x A595 mm
Tensão: Bivolt (127V / 220V)

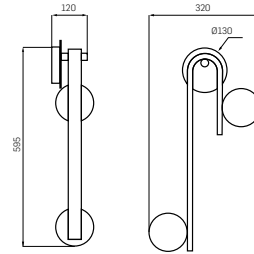

● **PD1408**
Pendente



● **PD1408BR**
Pendente

5xG9 LED 5W
Dim.: C1130 x L110 x A230 mm
Tensão: Bivolt (127V / 220V)
Cabo ajustável até 1,50 m

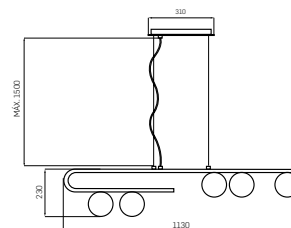



PD1408





PD1407BR

Lactite

Estrutura: Metal

Difusor: Vidro Transparente

Acabamento: Dourado

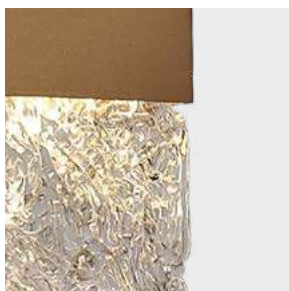

Detalhe do vidro



● **AR1411**
Arandela

LED 4W / 400lm / 3000k
Dim.: C220 x L80 x A220 mm
Tensão: Bivolt (127V / 220V)

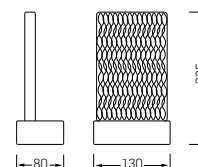

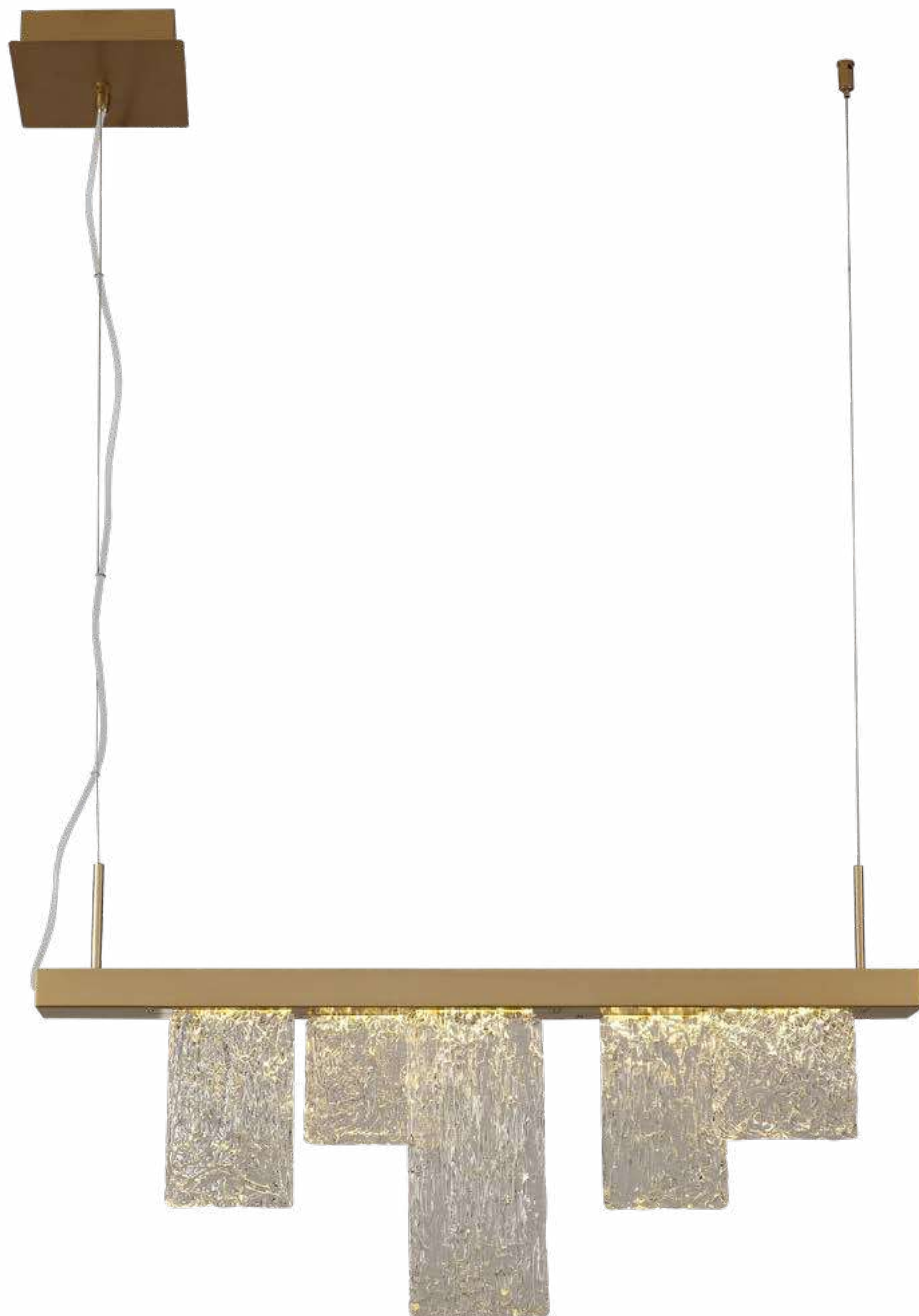

● **PD1410**
Pendente

LED 40W / 3740lm / 3000k
Dim.: C900 x L80 x A311 mm
Tensão: Bivolt (127V / 220V)
Cabo ajustável até 1,50 m

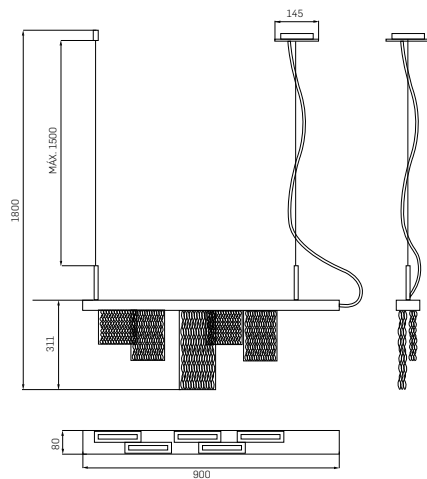

Lactite

Estrutura: Metal

Difusor: Vidro Transparente

Acabamento: Dourado



● PD1412 Pendente

LED 4,5W / 400lm / 3000k
Dimensões: C135 x A160 mm
Tensão: Bivolt (127V / 220V)
Cabo ajustável até 1,50 m

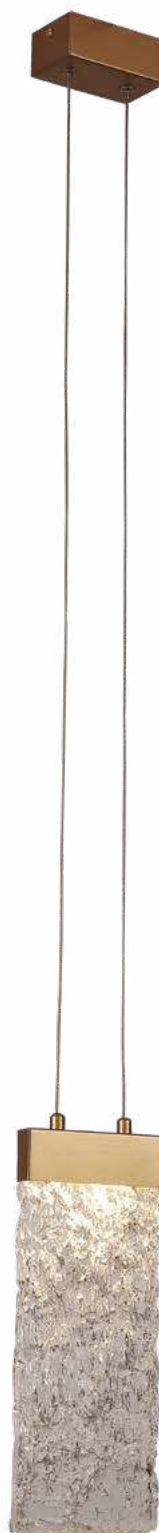
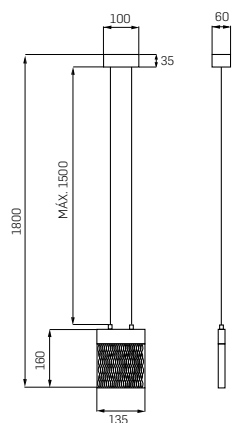

● PD1413 Pendente

LED 4,5W / 400lm / 3000k
Dimensões: C125 x A320 mm
Tensão: Bivolt (127V / 220V)
Cabo ajustável até 1,50 m

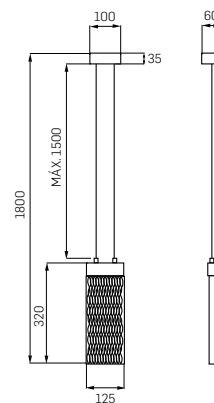



PD1412 + PD1413

Lynus

Estrutura: Metal

Difusor: Cristal transparente

Acabamento: Bronze

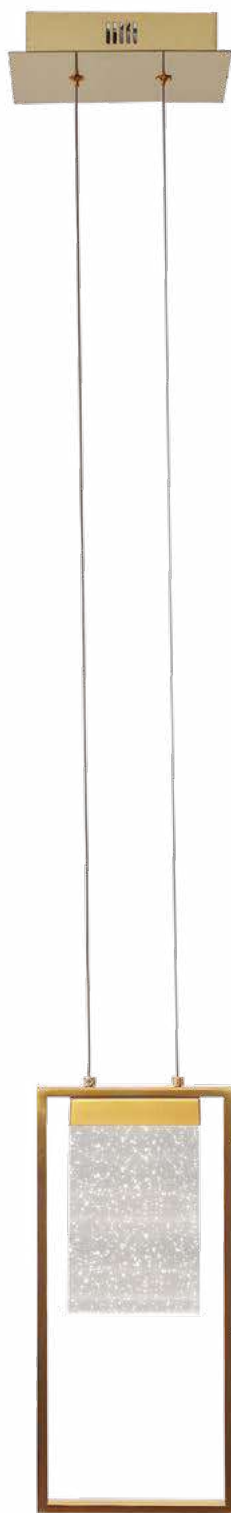

● **PD1471**
Pendente

LED 3W / 240 lm / 3000k
Dim.: C180 x A400 mm
Tensão: Bivolt (127V / 220V)
Cabo ajustável até 1,50 m

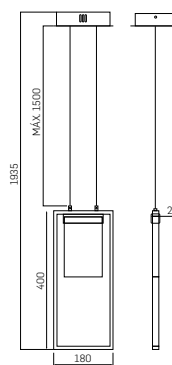

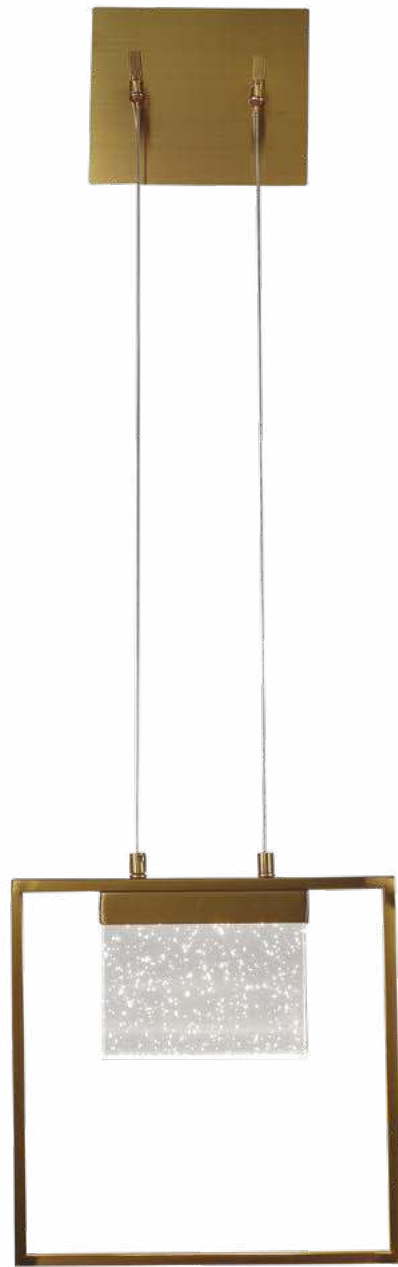
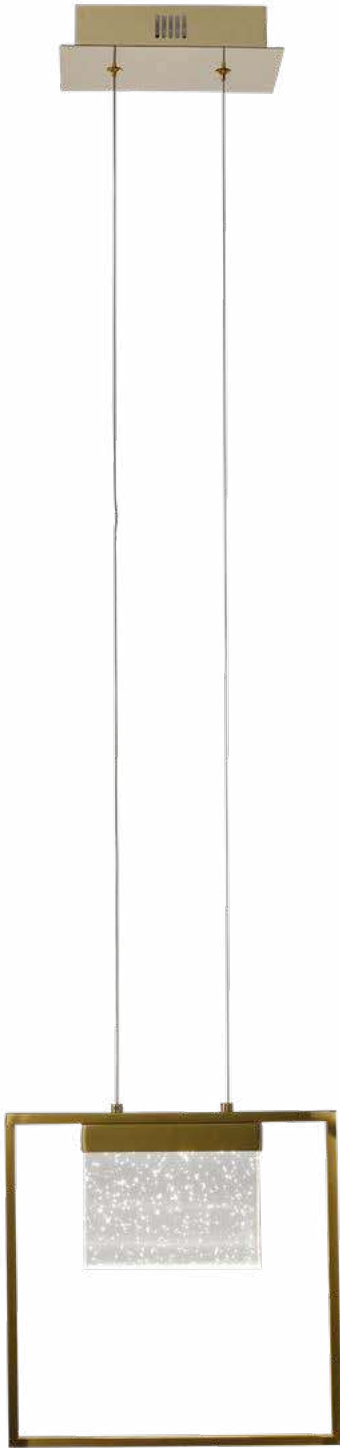

● **PD1472**
Pendente

LED 4W / 320 lm / 3000k
Dimensões: C300 xA300 mm
Tensão: Bivolt (127V / 220V)
Cabo ajustável até 1,50 m

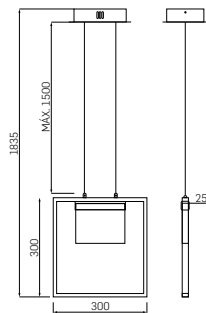

● **AR1468**
Arandela

LED 4W / 320 lm / 3000k
Dim.: C300 x L25 x A300 mm
Tensão: Bivolt (127V / 220V)
Cabo ajustável até 1,50 m

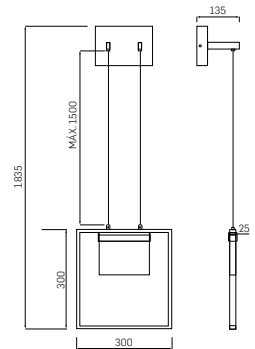

Maya

Estrutura: Metal

Difusor: Cristal transparente

Acabamento: Bronze

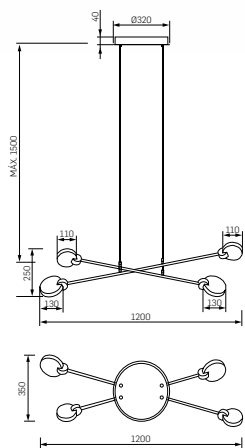

● **PD1473**
Pendente

LED 12W / 960 lm / 3000k
Dim.: C120 x L350 x A250 mm
Difusor: Ø110 / Ø130 mm
Tensão: Bivolt (127V / 220V)
Cabo ajustável até 1,50 m

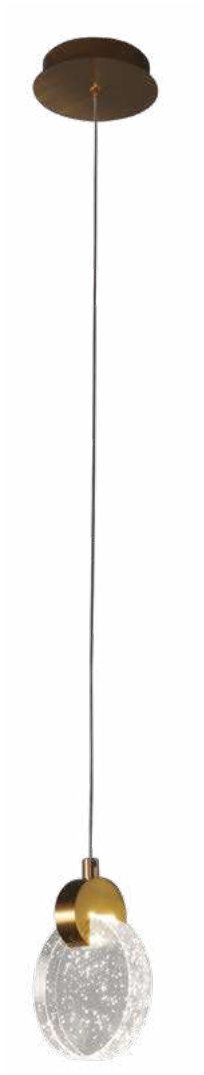

● **PD1474**
Pendente

LED 3W / 240 lm / 3000k
Dimensões: Ø110 x A150 mm
Difusor: Ø110 mm
Tensão: Bivolt (127V / 220V)
Cabo ajustável até 1,50 m

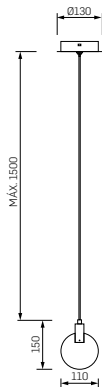

● **PD1475**
Pendente

LED 3W / 240 lm / 3000k
Dimensões: Ø130 x A170 mm
Difusor: Ø130 mm
Tensão: Bivolt (127V / 220V)
Cabo ajustável até 1,50 m

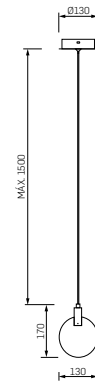

PD1474 / PD1475
Compatíveis com
canopla para gesso
(vendida separadamente)



PD1474 + PD1475

Maya

Estrutura: Metal

Difusor: Cristal transparente

Acabamento: Bronze



● AR1476

Arandela

LED 3W / 240 lm / 3000k

Dimensões: C130 x L83 x A160 mm

Difusor: Ø130 mm

Tensão: Bivolt (127V / 220V)

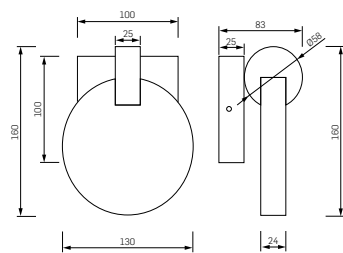



Blur

Estrutura: Metal

Difusor: Cristal de rocha

Acabamento: Preto

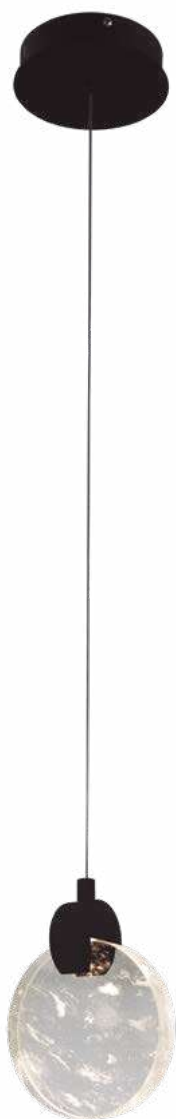

● **PD1494**
Pendente

LED 3W / 240lm / 3000k
Dim.: Ø130 x A170 mm
Tensão: Bivolt (127V/220V)
Cabo ajustável até 1,50 m

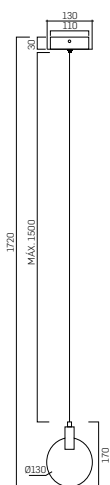

● **PD1495**
Pendente

LED 3W / 240lm / 3000k
Dim.: C128 x A160 mm
Tensão: Bivolt (127V/220V)
Cabo ajustável até 1,50 m

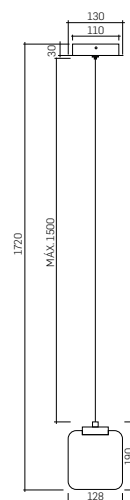



PD1494



PD1494
Compatível com
canopla para gesso
(vendida separadamente)

Diamond

Estrutura: Metal

Difusor: Vidro branco misto transparente

Acabamento: Dourado



● **AR1515**
Arandela

1xG9 / Máx. 5W
Dimensões: C116 x L162 x A355,5 mm
Tensão: Bivolt (127V/220V)

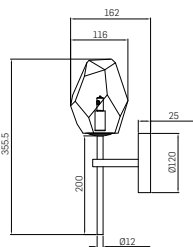

● **PD1516**
Pendente

1xG9 / Máx. 5W
Dimensões: C116 x A257,5 mm
Tensão: Bivolt (127V/220V)
Cabo ajustável até 2 m





Diamond

LANÇAMENTO 2022

Estrutura: Metal

Difusor: Vidro branco misto transparente

Acabamento: Dourado



● PD1715

Pendente

1xG9 5W

Dimensões: C1500 x L110 x A350 mm

Tensão: Bivolt (127V/220V)

Potência máxima: 5W

Cabo ajustável até 2000mm



Petram

Estrutura: Metal

Difusor: Vidro transparente

Acabamento: Dourada ou preta



PD1416DO / PD1416PT

Compatíveis com
canopla para gesso
(vendida separadamente)



● PD1416DO

● PD1416PT

Pendente

LED 2W / 260lm / 3000k
Dimensões: Ø100 x A600 mm
Tensão: Bivolt (127V/220V)
Cabo ajustável até 1,50 m

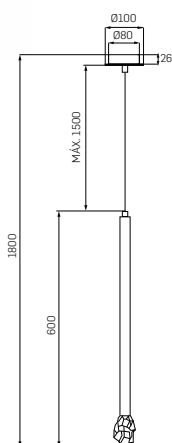

● AR1485DO

● AR1485PT

Arandela

LED 2W / 260lm / 3000k
Dim.: C55 x L90 x A600 mm
Tensão: Bivolt (127V/220V)

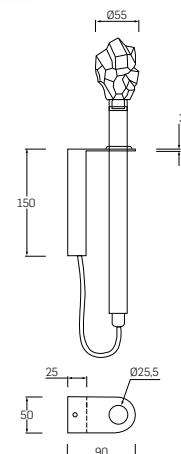



PD1416PT

Castillo

NOVOS
ACABAMENTOS
DOURADO E PRETO

Estrutura: Metal

Cristais decorativos com ajuste de posição

Acabamento: Marrom

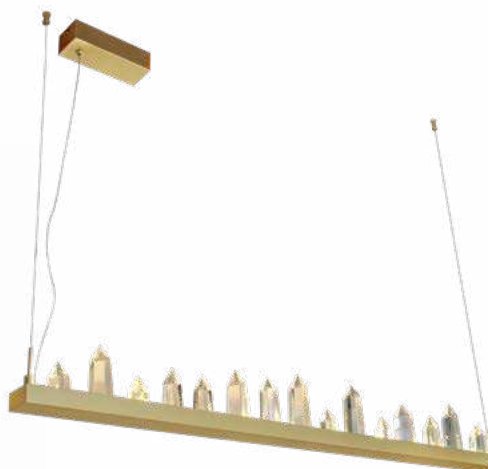
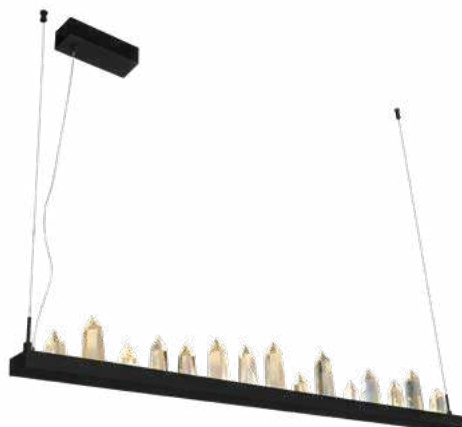

- PD1455
 - PD1455DO
 - PD1455PT
- Pendente

LED 36W / 3060lm / 3000k
Dimensões: C1200 x A140 mm
Cristais: 4xA80 + 4xA100 + 4xA120 + 3xA140 mm
Tensão: Bivolt (127V/220V)
Cabo ajustável até 1,50 m

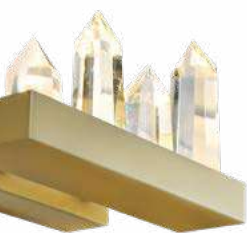
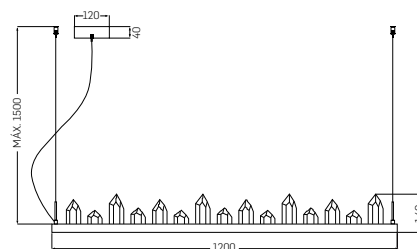

- AR1456
 - AR1456DO
 - AR1456PT
- Arandela

LED 8W / 680 lm / 3000k
Dimensões: C250 x A140 mm
Cristais: A80 + A100 + A120 + A140 mm
Tensão: Bivolt (127V/220V)

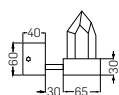

Sistema magnético para fixação/ajuste dos cristais



PD1455

Suez

Estrutura: Alumínio

Difusor: Material tipo alabastro

Acabamento: Dourado ou preto



● **ARSH1568DO**

● **ARSH1568PT**

Arandela

LED 8,4W / 167,4lm / 3000k
Potência Máx.: 8,4W
Dimensões: C145 x L80 x A300 mm
Tensão: Bivolt (127V/220V)

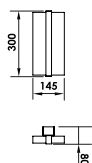

● **ARSH1569DO**

● **ARSH1569PT**

Arandela

LED 21W / 418,5lm / 3000k
Potência máx.: 21W
Dimensões: C145 x L80 x A550 mm
Tensão: Bivolt (127V/220V)

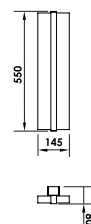



- ARSH1570DO
- ARSH1570PT

Arandela

LED 33,6W / 669,6lm / 3000k
Potência máx.: 33,6W
Dimensões: C145 x L80 x A800 mm
Tensão: Bivolt (127V/220V)

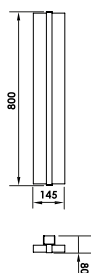

Suez

Estrutura: Alumínio

Difusor: Material tipo alabastro

Acabamento: Dourado ou preto



● LMSH1574DO

● LMSH1574PT

Luminária de mesa

LED 21W / 418,5lm / 3000k

Potência máx.: 21W

Dimensões: C160 x L110 x A640 mm

Tensão: Bivolt (127V/220V)

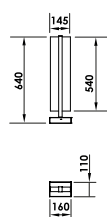

● CLSH1575DO

● CLSH1575PT

Coluna

LED 21W / 418,5lm / 3000k

Potência máx.: 21W

Dimensões: C160 x L160 x A1390 mm

Tensão: Bivolt (127V/220V)

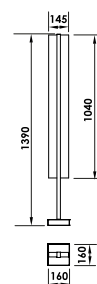

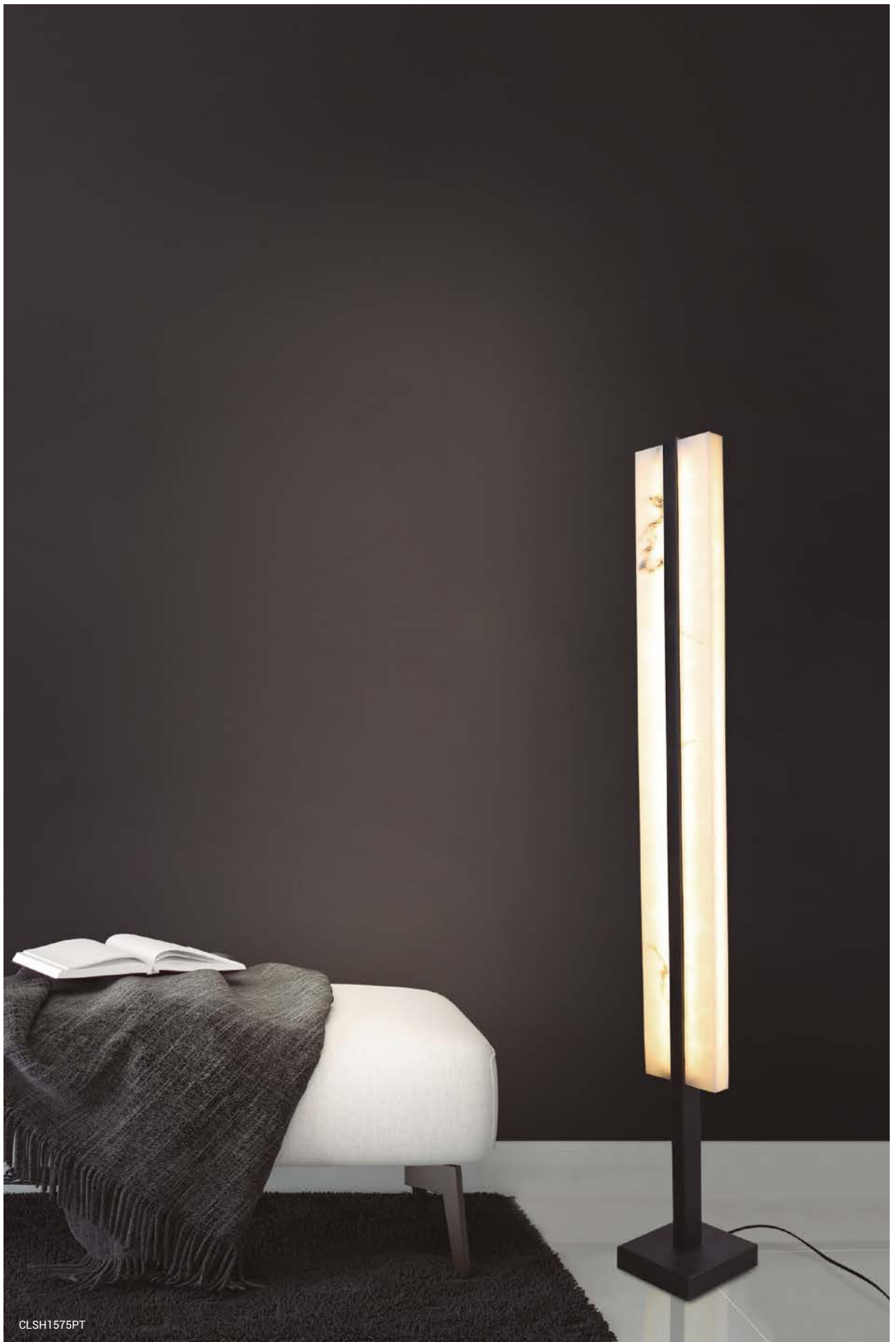

CLSH1575PT

Suez

Estrutura: Alumínio

Difusor: Material tipo alabastro

Acabamento: Dourado ou preto

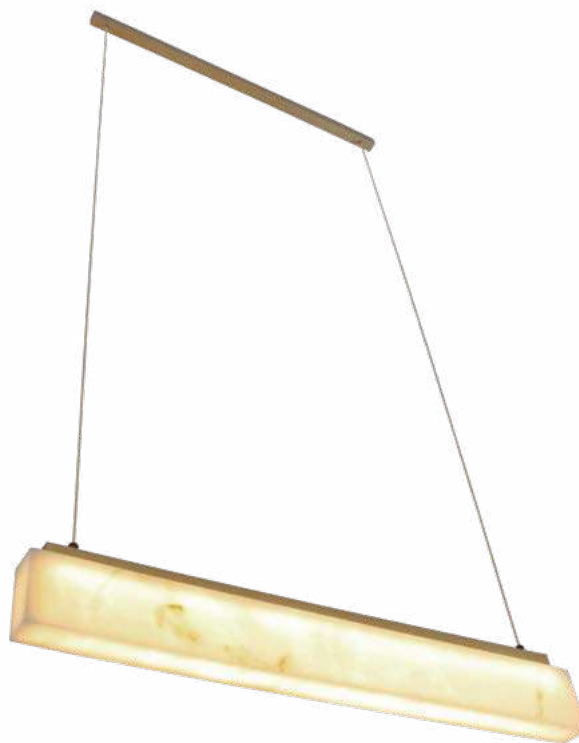

- PDSH1566LED1DO (127V)
- PDSH1566LED2DO (220V)
- PDSH1566LED1PT (127V)
- PDSH1566LED2PT (220V)

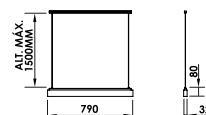

Pendente

LED 13,2W / 270lm / 3000k
Potência máx.: 13,2W
Dimensões: C790 x L80 x A32 mm
Tensão: 127V ou 220V



- PDSH1567LED1DO (127V)
- PDSH1567LED2DO (220V)
- PDSH1567LED1PT (127V)
- PDSH1567LED2PT (220V)

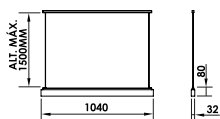

Pendente

LED 17,6W / 360lm / 3000k
Potência máx.: 17,6W
Dimensões: C1040 x L80 x A32 mm
Tensão: 127V ou 220V



PDSH1567LED1PT

Suez

Estrutura: Alumínio

Difusor: Material tipo alabastro

Acabamento: Dourado ou preto



- PLSH1561LED1DO (127V)
- PLSH1561LED2DO (220V)
- PLSH1561LED1PT (127V)
- PLSH1561LED2PT (220V)

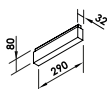

Plafon

LED 4,4W / 90lm / 3000k
Potência máx.: 4,4W
Dimensões: C290 x L80 x A32 mm
Tensão: 127V ou 220V

- PLSH1562LED1DO (127V)
- PLSH1562LED2DO (220V)
- PLSH1562LED1PT (127V)
- PLSH1562LED2PT (220V)

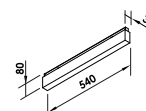

Plafon

LED 8,8W / 180lm / 3000k
Potência máx.: 8,8W
Dimensões: C540 x L80 x A32 mm
Tensão: 127V ou 220V



PLSH1563LED1PT



- PLSH1563LED1DO (127V)
- PLSH1563LED2DO (220V)
- PLSH1563LED1PT (127V)
- PLSH1563LED2PT (220V)

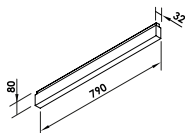

Plafon

LED 13,2W / 270lm / 3000k

Potência máx.: 13,2W

Dimensões: C790 x L80 x A32 mm

Tensão: 127V ou 220V



- PLSH1564LED1DO (127V)
- PLSH1564LED2DO (220V)
- PLSH1564LED1PT (127V)
- PLSH1564LED2PT (220V)

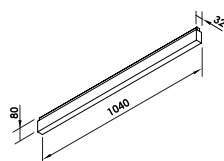

Plafon

LED 17,6W / 360lm / 3000k

Potência máx.: 17,6W

Dimensões: C1040 x L80 x A32 mm

Tensão: 127V ou 220V

Suez

Estrutura: Alumínio

Difusor: Material tipo alabastro

Acabamento: Dourado ou preto



● **PLSH1589DO**

● **PLSH1589PT**

Plafon

LED 26,6W / 630lm / 3000k

Potência máx.: 26,6W

Dimensões: C540 x L540 x A40 mm

Tensão: 127V / 220V

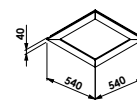

● **PLSH1588DO**

● **PLSH1588PT**

Plafon

LED 19W / 450lm / 3000k

Potência máx.: 19W

Dimensões: C400 x L400 x A40 mm

Tensão: 127V / 220V

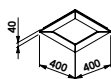



PLSH1589DO

Suez

Estrutura: Alumínio

Difusor: Material tipo alabastro

Acabamento: Dourado ou preto



- PDSH1572DO
- PDSH1572PT

Pendente

LED 8,4W / 167,4lm / 3000k
Potência máx.: 8,4W
Dimensões: C145 x L40 x A300 mm
Tensão: Bivolt (127V/220V)

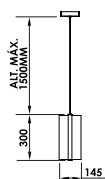

- PDSH1573DO
- PDSH1573PT

Pendente

LED 21W / 418,5lm / 3000k
Potência máx.: 21W
Dimensões: C145 x L40 x A550 mm
Tensão: Bivolt (127V/220V)

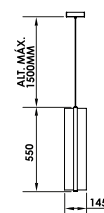

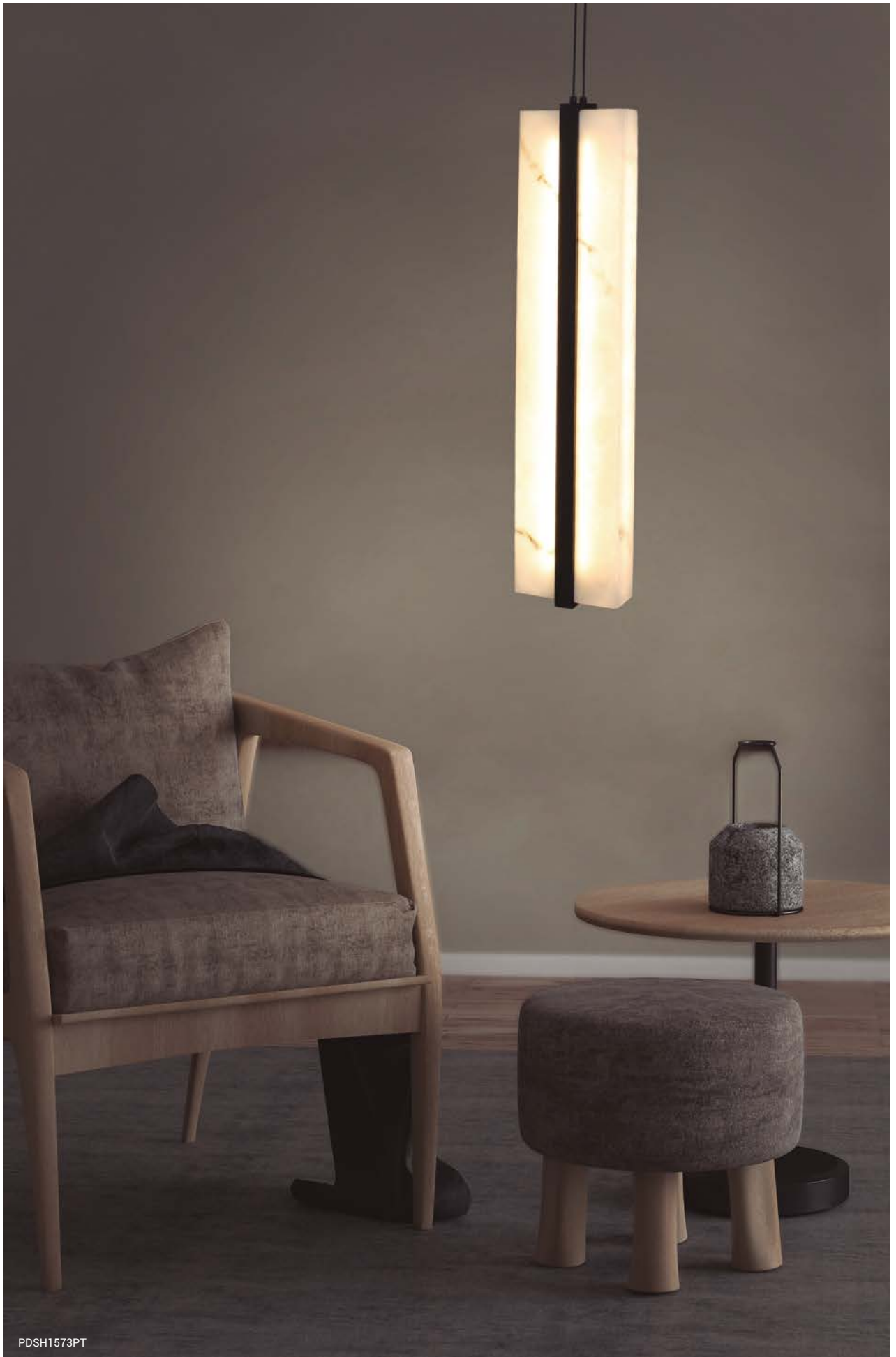

PDSH1573PT

Suez

Estrutura: Alumínio

Difusor: Material tipo alabastro

Acabamento: Dourado ou preto



- PDSH1575DO
- PDSH1575PT

Pendente

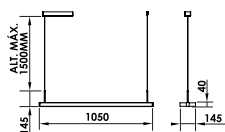

LED 42W / 837lm / 3000k
Potência máx.: 42W
Dimensões: C1050 x L145 x A40 mm
Tensão: Bivolt (127V/220V)



PDSH1575D0

Anello

Estrutura: Metal/alumínio/acrílico

Acrílico: Transparente

Acabamento: Dourado

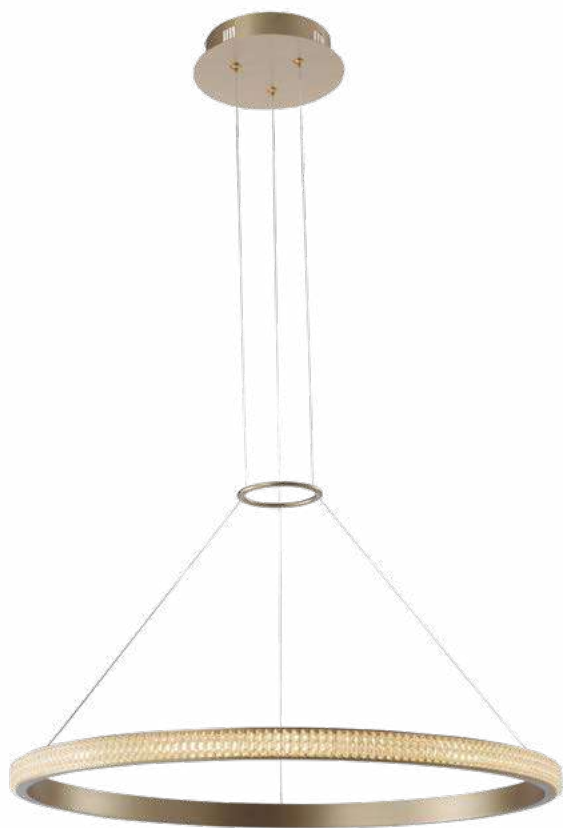

● PD1440 Pendente

LED 28W / 1400lm / 3000k
Dimensões: Ø605 x A1200 mm
Tensão: Bivolt (127V/220V)
Cabo ajustável até 1,50 m

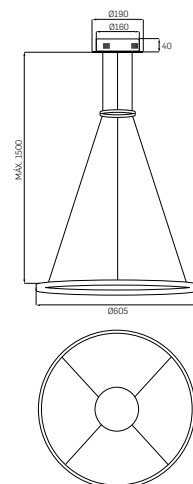

● PD1441 Pendente

LED 40W / 2000lm / 3000k
Dim.: Ø670 + Ø480 x A1500 mm
Tensão: Bivolt (127V/220V)
Cabo ajustável até 1,50 m

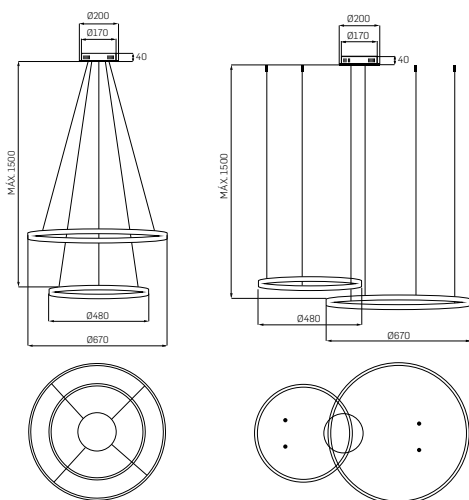



PD1440



● **AR1487**
Arandela

LED 7W / 350lm / 3000k
Dimensões: C350 x A30 mm
Tensão: Bivolt (127V/220V)

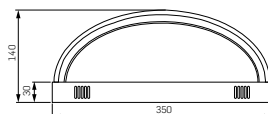

Anello

Estrutura: Metal/alumínio/acrílico

Acrílico: Transparente

Acabamento: Dourado

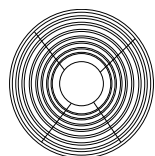
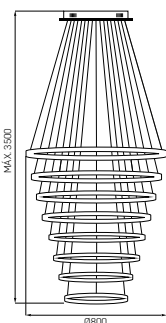

● **PD1442**
Pendente

LED 180W / 9000lm / 3000k
Dimensões:
Ø800 + Ø730 + Ø670 + Ø605 +
Ø540 + Ø480 + Ø415 + Ø350 x
A3500 mm
Tensão: Bivolt (127V/220V)
Cabo ajustável até 3,50 m

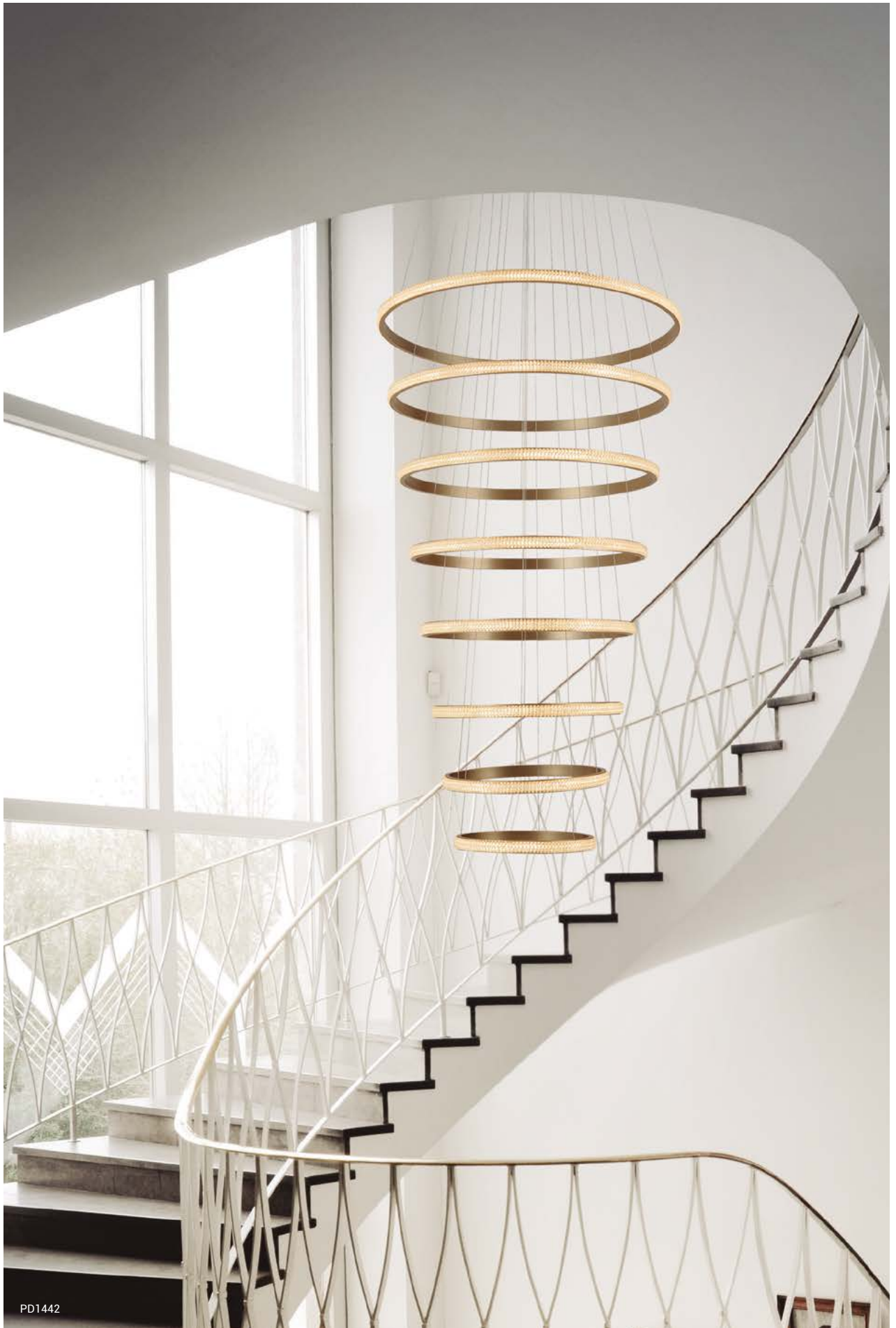

PD1442

Anello Oval

Estrutura: Metal/alumínio/acrílico

Acrílico: Transparente

Acabamento: Dourado



● PD1444 Pendente

LED 38W / 1900lm / 3000k
Dim.: Ø800+Ø570 x A30+30 mm
Tensão: Bivolt (127V/220V)
Cabo ajustável até 1,50 m

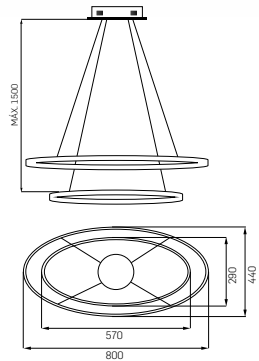

● PD1443 Pendente

LED 28W / 1400lm / 3000k
Dimensões: Ø800 x A30 mm
Tensão: Bivolt (127V/220V)
Cabo ajustável até 1,50 m

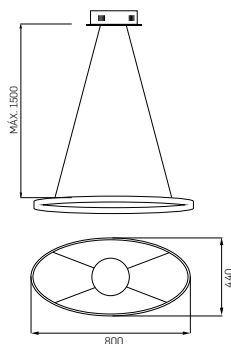



Pectus

Estrutura: Alumínio
 Difusor: Sílica gel branco
 Acabamento: Dourado



● **PD1400**
 Pendente

LED 43W / 3440lm / 3000k
 Dimensões: Ø600 x A135 mm
 Tensão: Bivolt (127V/220V)
 Cabo ajustável até 1,50 m

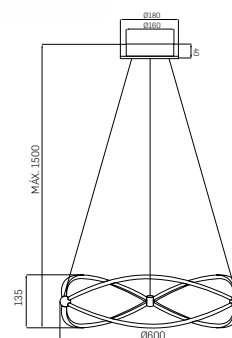

● **AR1402**
 Arandela

LED 11W / 880lm / 3000k
 Dimensões: C395 x L145 x A120 mm
 Tensão: Bivolt (127V/220V)

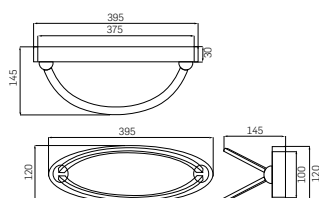

● **PD1401**
 Pendente

LED 54W / 4320lm / 3000k
 Dimensões: Ø800 x A160 mm
 Tensão: Bivolt (127V/220V)
 Cabo ajustável até 1,50 m

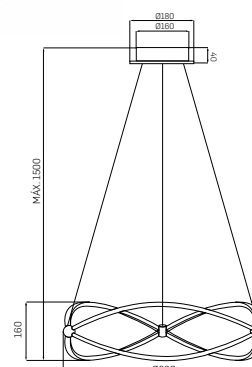



PD1400

Horizon

Estrutura: Alumínio / metal
Difusor: Acrílico branco
Acabamento: Ouro escovado



PD1437

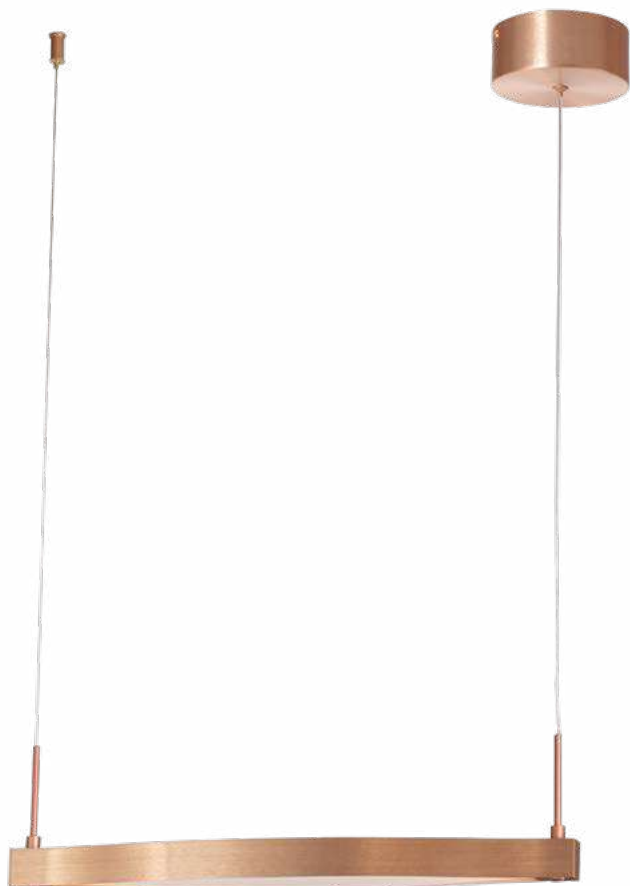

● **PD1437**
Pendente

LED 12W / 900lm / 3000k
Dim.: C490 x L80 x A32 mm
Tensão: Bivolt (127V/220V)
Cabo ajustável até 1,50 m

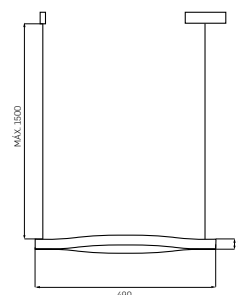



● **PD1438**
Pendente

LED 30W / 1800lm / 3000k
Dimensões: C960 x L80 x A32 mm
Tensão: Bivolt (127V/220V)
Cabo ajustável até 1,50 m

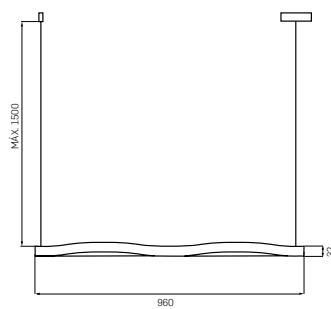

Eclipse

Estrutura: Metal + couro marrom

Difusor: Silica gel

Acabamento: Dourado

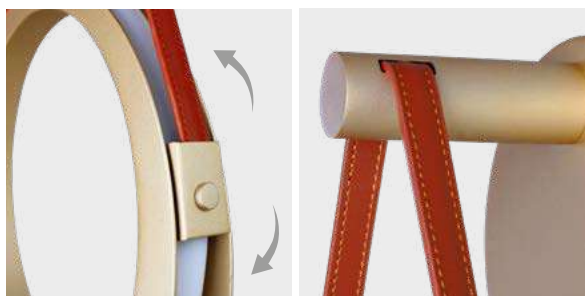

Iluminação em toda parte externa do aro



● **AR1504**
Arandela

13W / 780 lm / 3000k

Dimensões: Ø300 x L120 x A551 mm

Tensão: Bivolt (127V/220V)

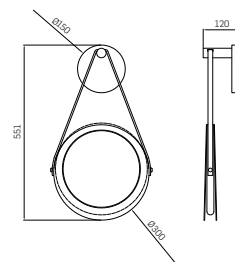

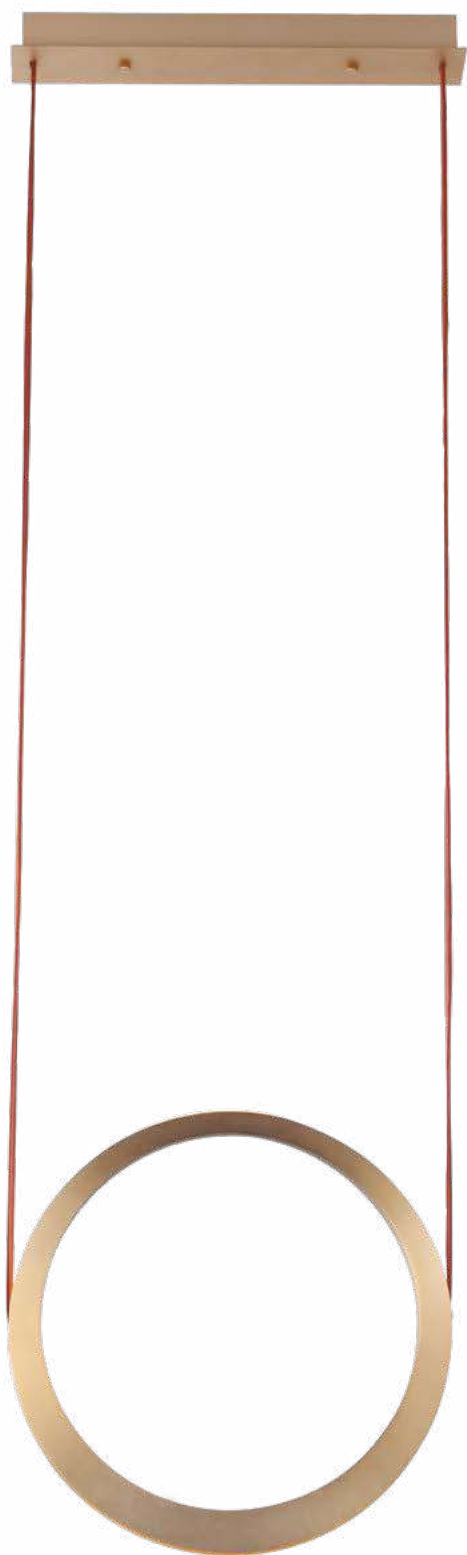

● **PD1505**
Pendente

23W / 1380 lm / 3000k
Dimensões: Ø400 x A1942 mm
Tensão: Bivolt (127V/220V)
Alça de couro ajustável até 1,70 m

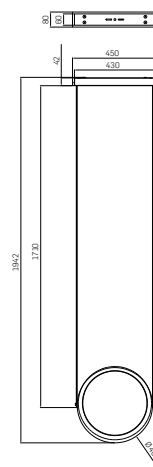

Drain

Estrutura: Alumínio

Cúpula: Tecido branco ou preto

Acabamento: Cromado ou preto



Hastes ajustáveis



- AR977
- AR977PT

Arandela

1xE27 / 40W

Potência máx.: 40W

Dim.: L370~870 x A270~570 mm

Cúpula Ø200 mm

Tensão: Bivolt (127V/220V)

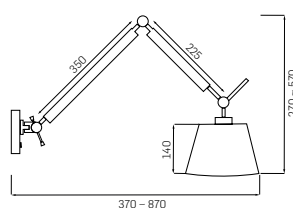



● AR978

● AR978PT

Arandela

1xE27 / 40W
Potência máx.: 40W
Dim.: L285 x A270 mm
Cúpula Ø200 mm
Tensão: Bivolt (127V/220V)

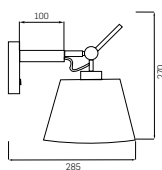

Drain

Estrutura: Alumínio

Cúpula: Tecido branco ou preto

Acabamento: Cromado ou preto



Hastes ajustáveis



- PD976
 - PD976PT
- Pendente

1xE27 / 40W
Potência máx.: 40W
Dim.: C260~640 x A600~1400 mm
Cúpula Ø260 mm
Tensão: Bivolt (127V/220V)

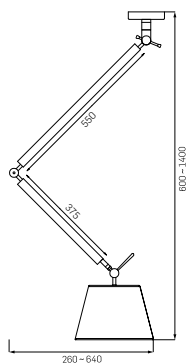

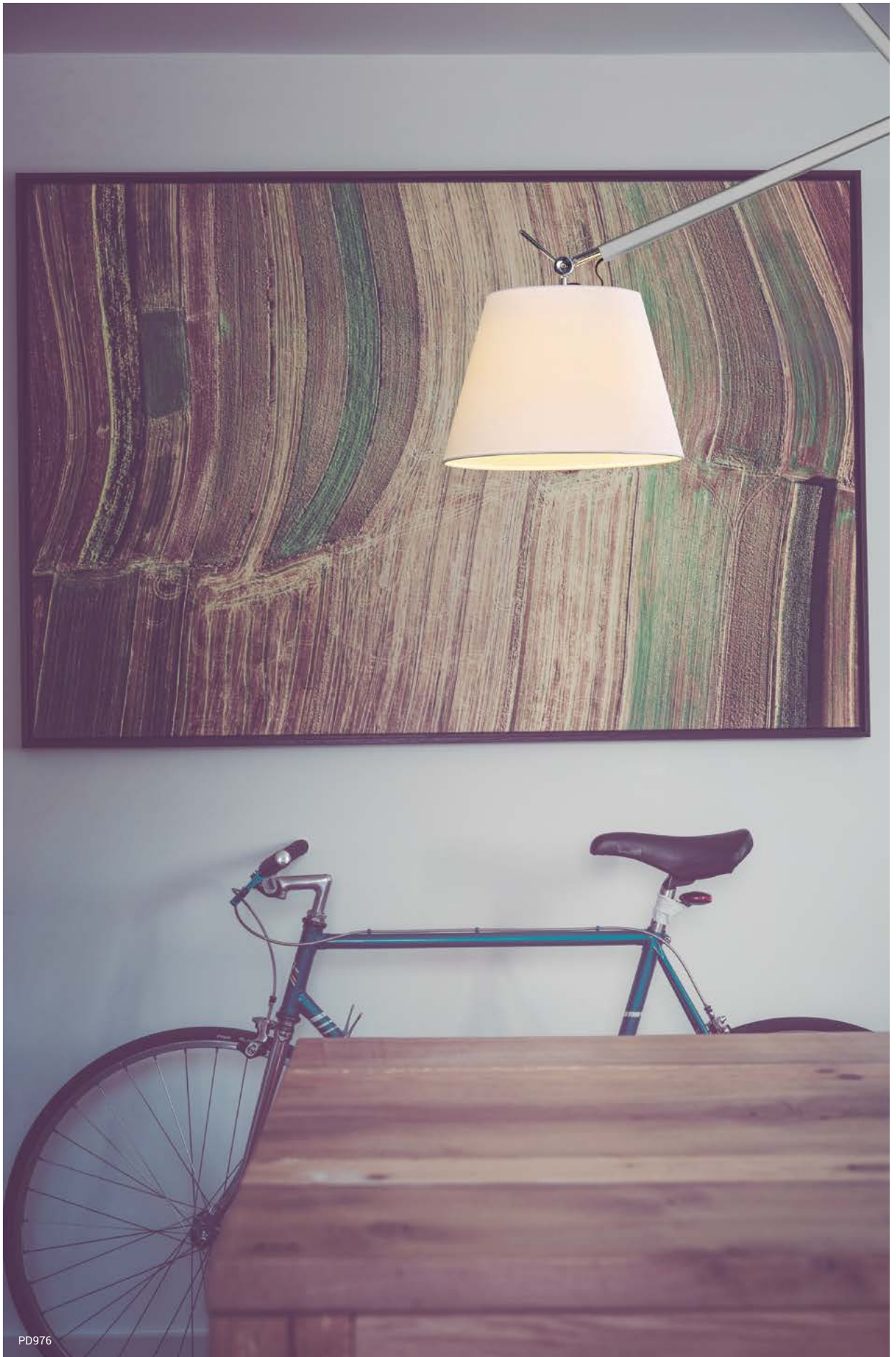

PD976

Drain





PD976PT

Drain Office

Estrutura: Alumínio e metal

Cúpula: Alumínio e metal

Acabamento: Prata/cromado ou preto

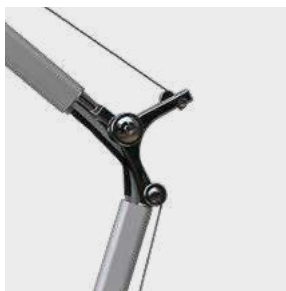

Hastes ajustáveis



● **LM1603**

● **LM1603PT**

Luminária de mesa

1xE27 / 40W

Potência máx.: 40W

Dim.: C500 x L210 x A633 mm

Cúpula Ø145 mm

Tensão: Bivolt (127V/220V)

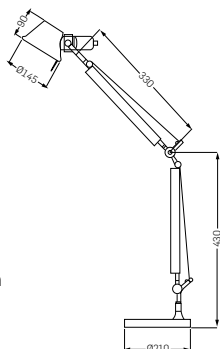

● **CL1604**

● **CL1604PT**

Coluna

1xE27 / 40W

Potência máx.: 40W

Dim.: C800 x L280 x A1650 mm

Cúpula Ø145 mm

Tensão: Bivolt (127V/220V)

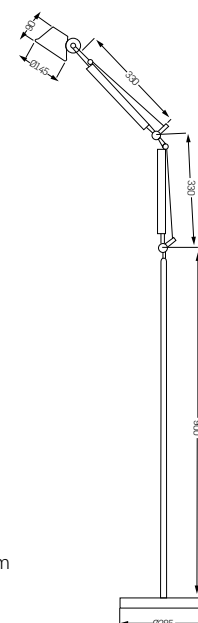



- **AR1605**
- **AR1605PT**

Arandela

1xE27 / 40W
 Potência máx.: 40W
 Dim.: C260 x L115 x A230 mm
 Cúpula Ø145 mm
 Tensão: Bivolt (127V/220V)

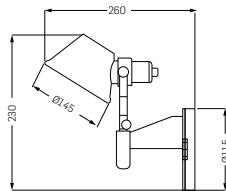

- **AR1606**
- **AR1606PT**

Arandela

1xE27 / 40W
 Potência máx.: 40W
 Dim.: C850 x L115 x A370 mm
 Cúpula Ø145 mm
 Tensão: Bivolt (127V/220V)

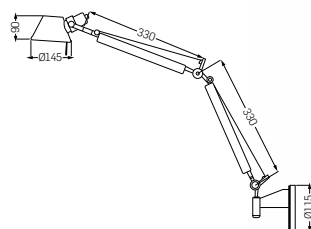



AR1606



LM1603PT



BA001CR

Abajur

1x E27 40W
Dimensões: 110 x A470 mm
Acabamento: cromado
Tensão: Bivolt (127V/220V)
Potência máxima: 40W
Cabo 1500mm



BA001DO

Abajur

1x E27 40W
Dimensões: 110 x A470 mm
Acabamento: dourado
Tensão: Bivolt (127V/220V)
Potência máxima: 40W
Cabo 1500mm



BA002

Abajur

1x E27 40W
Dimensões: 160 x A500 mm
Tensão: Bivolt (127V/220V)
Potência máxima: 40W
Cabo 1500mm



BA003

Abajur

1x E27 40W
Dimensões: 120 x L120 x A420 mm
Acabamento: Mármore preto
Tensão: Bivolt (127V/220V)
Potência máxima: 40W
Cabo 1500mm



BA004
Abajur

1x E27 40W
Dimensões: 220 x L120 x A440 mm
Acabamento: Mármore preto
Tensão: Bivolt (127V/220V)
Potência máxima: 40W
Cabo 1500mm



BA005
Abajur

1x E27 40W
Dimensões: 280 x L120 x A320 mm
Tensão: Bivolt (127V/220V)
Potência máxima: 40W
Cabo 1500mm



BA006

Abajur

1x E27 40W
Dimensões: 150 x L150 x A550 mm
Tensão: Bivolt (127V/220V)
Potência máxima: 40W
Cabo 1500mm



BA007

Abajur

1x E27 40W
Dimensões: 280 x L120 x A320 mm
Tensão: Bivolt (127V/220V)
Potência máxima: 40W
Cabo 1500mm

BASES DE ABAJUR

LANÇAMENTO 2022



BA008
Abajur

1x E27 40W
Dimensões: 120 x A520 mm
Tensão: Bivolt (127V/220V)
Potência máxima: 40W
Cabo 1500mm



BA009
Abajur

1x E27 40W
Dimensões: 120 x L100 x A470 mm
Tensão: Bivolt (127V/220V)
Potência máxima: 40W
Cabo 1500mm



BA010

Abajur

1x E27 40W
Dimensões: 120 x L480 x A480 mm
Tensão: Bivolt (127V/220V)
Potência máxima: 40W
Cabo 1500mm



BA011

Abajur

1x E27 40W
Dimensões: 250 x L100 x A460 mm
Tensão: Bivolt (127V/220V)
Potência máxima: 40W
Cabo 1500mm



BA012

Abajur

1x E27 40W

Dimensões: 180 x L130 x A527 mm

Material: Cristal

Tensão: Bivolt (127V/220V)

Potência máxima: 40W

Cabo 1500mm



BA013

Abajur

1x E27 40W

Dimensões: 180 x L130 x A527 mm

Material: Cristal

Tensão: Bivolt (127V/220V)

Potência máxima: 40W

Cabo 1500mm



BA015

Abajur

1x E27 40W
Dimensões: 100 x A395 mm
Material: Cristal
Tensão: Bivolt (127V/220V)
Potência máxima: 40W
Cabo 1500mm



BA016

Abajur

1x E27 40W
Dimensões: 140 x A430 mm
Material: Cristal
Tensão: Bivolt (127V/220V)
Potência máxima: 40W
Cabo 1500mm



BA017

Abajur

1x E27 40W
Dimensões: 120 x A424 mm
Material: Cristal
Tensão: Bivolt (127V/220V)
Potência máxima: 40W
Cabo 1500mm

CÚPULAS DE ABAJUR

LANÇAMENTO 2022



CUP001BR

CUP001PT

CUP001BG

CUP001FD

CUP001

Cúpula Cilíndrica

Material: Tecido

Dimensões: 400 x 400 x 300 mm



CUP002BR

CUP002PT

CUP002BG

CUP002FD

CUP002

Cúpula Cilíndrica

Material: Tecido

Dimensões: 300 x 300 x 350 mm



CUP003
Cúpula Retangular

Material: Tecido
Dimensões: 400 x 230 x 300 mm



CUP004
Cúpula Conica

Material: Tecido
Dimensões: 420 x 340 x 332 mm

CANOPLA SLIM PARA GESSO

Fácil instalação, proporciona um ambiente clean e permite maior variedade em suas composições. Para a instalação, é necessária a desmontagem do produto original e alocar o driver no teto, permanecendo embutido no gesso.



● CAN009DO
● CAN009PT
Ø55 mm

Compatíveis com:

PD1508PT / PD1508DO
PD1488DO / PD1488PT
PD1474 / PD1475
PD1416DO / PD1416PT
PD1494 / PD1495

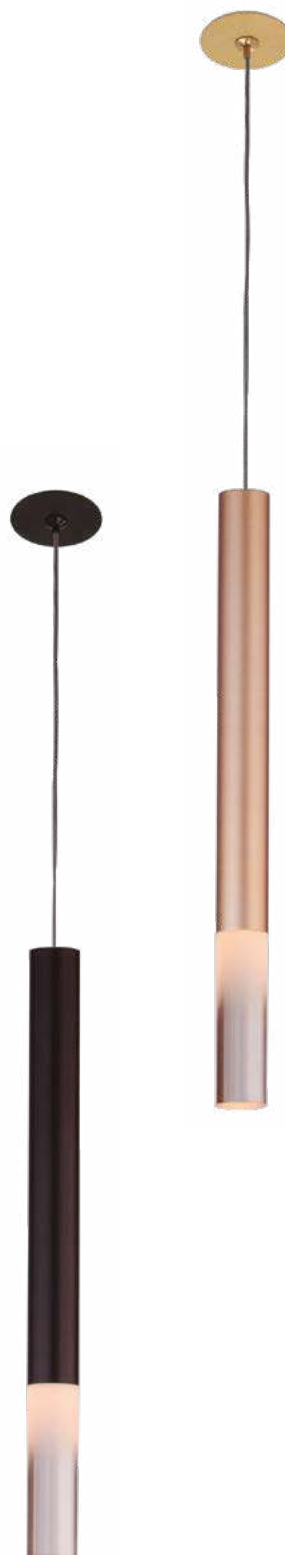



PD1508PT

Volpi

LANÇAMENTO 2022

Estrutura: Metal/ Alumínio/ Sílica gel
Acabamento: Preto, branco ou dourado

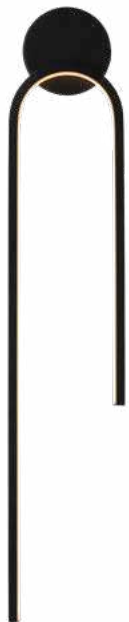

● **AR1669PT**
Arandela

LED 10W
Lúmens: 700lm
Temperatura: 3000K
Dimensões: C140 x L22 x A650 mm
Tensão: Bivolt (127V/220V)
Potência máxima: 10W



AR1669BR

LED light



AR1669BR



AR1669PT



AR1669BDO

Jadore

LANÇAMENTO 2022

Estrutura: Metal / Cristal
Difusor: Cristal de rocha
Acabamento: Preto ou dourado



Detalhe do difusor



● **PD1688OX**
Pendente

LED 4W
Lúmens: 280lm
Temperatura: 3000K
Dimensões: Ø100 x A800 mm
Tensão: Bivolt (127V/220V)
Potência máxima: 4W
Cabo ajustável até 1500mm



PD1688DO



PD1688OX

Wala

LANÇAMENTO 2022

Estrutura: Metal/ Acrílico

Acabamento: Dourado ou Preto (onix)



● PD1686DO

Pendente

LED 12W

Lúmens: 960lm

Temperatura: 3000K

Dimensões: C140 x L22 x A650 mm

Tensão: Bivolt (127V/220V)

Potência máxima: 12W

Cabo ajustável até 1500mm

● CL1687DO

Coluna

LED 18W

Lúmens: 1440lm

Temperatura: 3000K

Dimensões: Ø200 x A1200 mm

Tensão: Bivolt (127V/220V)

Potência máxima: 18W



PD1686DO



PD1686OX



CL1687DO



CL1687OX



● **AB1685DO**
Abajur

LED 12W
Lúmens: 960lm
Temperatura: 3000K
Dimensões: 150 x A525 mm
Tensão: Bivolt (127V/220V)
Potência máxima: 12W



AB1685DO



AB1685OX



CL16870X

Allure

LANÇAMENTO 2022

Estrutura: Metal / Acrílico

Difusor: Acrílico

Acabamento: Preto (onix) / Dourado

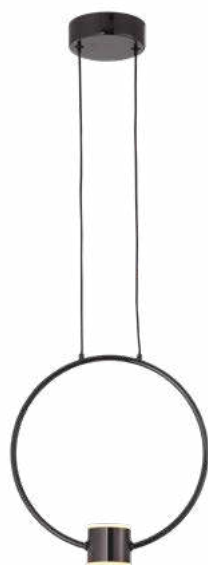

● PD17000X

Pendente

LED 2X5W

Lúmens: 800lm

Temperatura: 3000K

Dimensões: Ø300 x L65 mm

Tensão: Bivolt (127V/220V)

Potência máxima: 10W

Cabo ajustável até 2000mm

● PD1701DO

Pendente

LED 2X5W

Lúmens: 800lm

Temperatura: 3000K

Dimensões: Ø500 x L65 mm

Tensão: Bivolt (127V/220V)

Potência máxima: 10W

Cabo ajustável até 2000mm



PD1700DO

PD17000X



PD1701DO

PD17010X

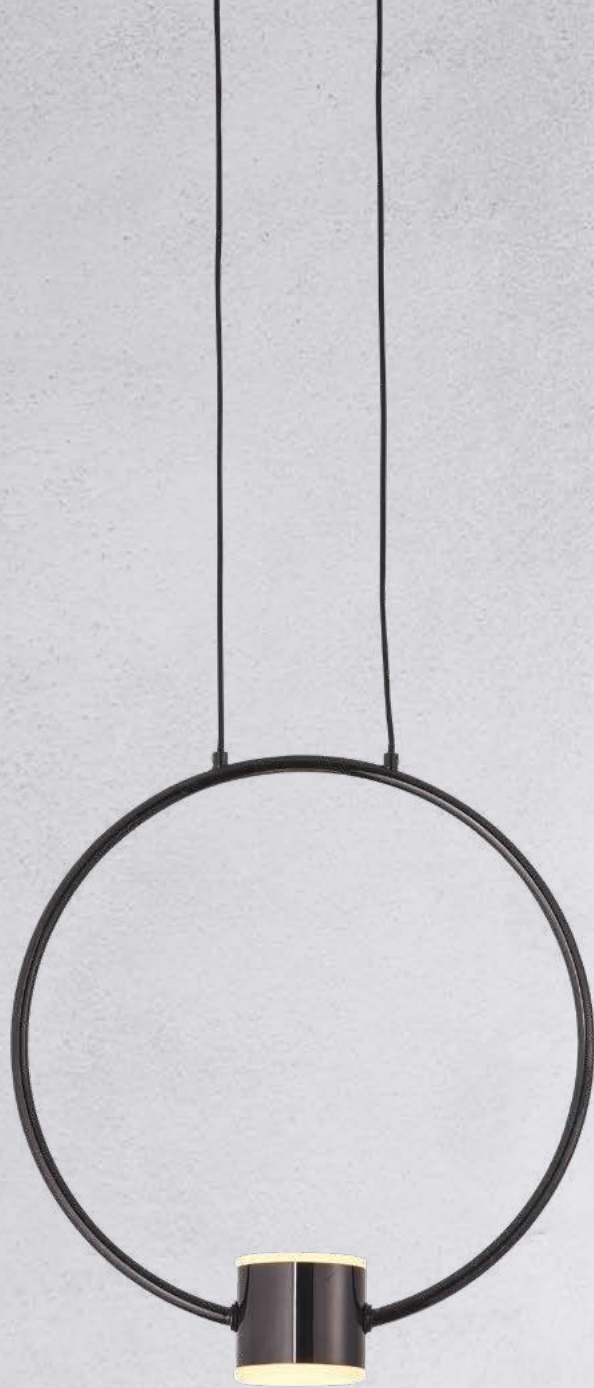

Fusion

LANÇAMENTO 2022

Estrutura: Metal/Alumínio/ Acrílico/ sílica gel
Acabamento: Preto ou dourado

LED light



● PD1680DO

Pendente

LED 36W
Lúmens: 2520lm
Temperatura: 3000K
Dimensões: C480 x L100 x A660 mm
Tensão: Bivolt (127V/220V)
Potência máxima: 36W
Cabo ajustável até 1500mm



PD1680DO

PD1680PT



● PD1681PT

Pendente

LED 36W
Lúmens: 2520lm
Temperatura: 3000K
Dimensões: C710 x L100 x A516 mm
Tensão: Bivolt (127V/220V)
Potência máxima: 36W
Cabo ajustável até 1500mm

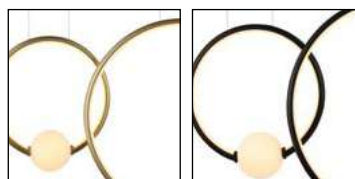

PD1681DO

PD1681PT

Ritz

LANÇAMENTO 2022

Estrutura: Metal/Alumínio/ Acrílico
Difusor: esfera branco opalino
Acabamento: Preto com detalhe dourado

LED light



● PD1678

Pendente

LED 45W
Lúmens: 3150lm
Temperatura: 3000K
Dimensões: C1500 x L100 x A550 mm
Tensão: Bivolt (127V/220V)
Potência máxima: 45W
Cabo ajustável até 1500mm



● PD1679

Pendente

LED 36W
Lúmens: 2520lm
Temperatura: 3000K
Dimensões: C1200 x L100 x A400 mm
Tensão: Bivolt (127V/220V)
Potência máxima: 36W
Cabo ajustável até 1500mm



Detalhe dourado do difusor

Avis

LANÇAMENTO 2022

Estrutura: Alumínio/ Sílica gel

Acabamento: Preto, branco ou dourado

LED light



● AR1689DO

Arandela

LED 15W

Lúmens: 1050lm

Temperatura: 3000K

Dimensões: C600 x L35 x A148 mm

Tensão: Bivolt (127V/220V)

Potência máxima: 15W



AR1689BR

AR1689PT

AR1689DO

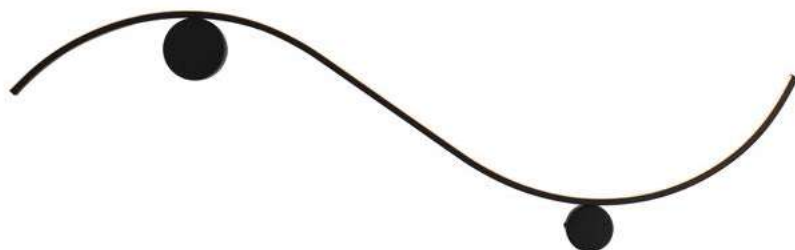

● **AR1690PT**

Arandela

LED 20W

Lúmens: 1400lm

Temperatura: 3000K

Dimensões: C1000 x L35 x A290 mm

Tensão: Bivolt (127V/220V)

Potência máxima: 20W



AR1690BR

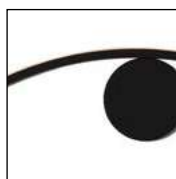

AR1690PT



AR1690DO

Kira

LANÇAMENTO 2022

Estrutura: Alumínio/ Sílica gel
Acabamento: Preto, branco ou dourado

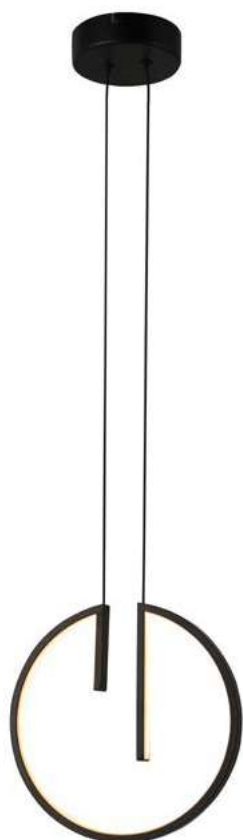

LED light

● PD1617PT

Pendente

LED 18W
Lúmens: 1260lm
Temperatura: 3000K
Dimensões: C240 x L20 x A238 mm
Tensão: Bivolt (127V/220V)
Potência máxima: 18W
Cabo ajustável até 1500mm



PD1617BR



PD1617PT



PD1617DO

Asha

LANÇAMENTO 2022

Estrutura: Metal/Alumínio/ Acrílico
Acabamento: Preto ou Branco

LED light



● **PL1656BR**
Plafon/Arandela

LED 30W
Lúmens: 1500lm
Temperatura: 3000K
Dimensões: C800 x L660 x P85 mm
Tensão: Bivolt (127V/220V)
Potência máxima: 30W



PL1656BR



PL1656PT



PL1656BR

Calla

LANÇAMENTO 2022

Estrutura: Metal/Alumínio/ Acrílico

Acabamento: Preto, Branco co Dourado



● AR1653DO

Arandela

LED 6W

Lúmens: 300lm

Temperatura: 3000K

Dimensões: Ø150 mm

Tensão: Bivolt (127V/220V)

Potência máxima: 6W

● AR1655PT

Arandela

LED 6W

Lúmens: 300lm

Temperatura: 3000K

Dimensões: C120 x L40 x A110 mm

Tensão: Bivolt (127V/220V)

Potência máxima: 6W

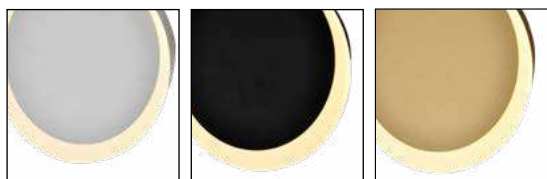

AR1653BR

AR1653PT

AR1653DO



AR1655BR

AR1655PT

AR1655DO

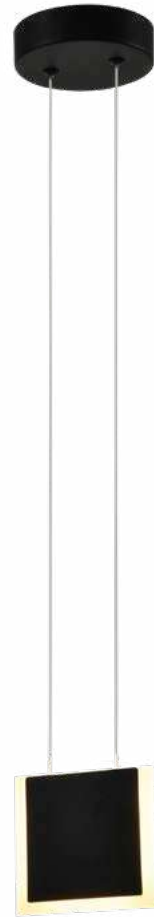
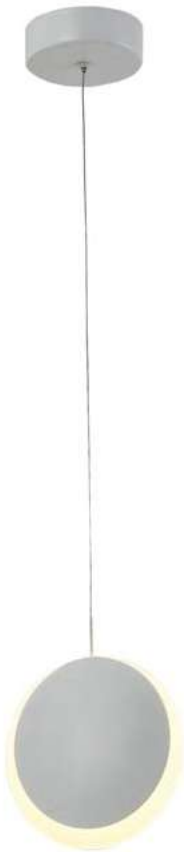

● **PD1652BR**

Pendente

LED 6W
 Lúmens: 300lm
 Temperatura: 3000K
 Dimensões: Ø150 mm
 Tensão: Bivolt (127V/220V)
 Potência máxima: 6W
 Cabo ajustável até 1500mm

● **PD1654PT**

Pendente

LED 6W
 Lúmens: 300lm
 Temperatura: 3000K
 Dimensões: C120 x L10 x A110 mm
 Tensão: Bivolt (127V/220V)
 Potência máxima: 6W
 Cabo ajustável até 1500mm

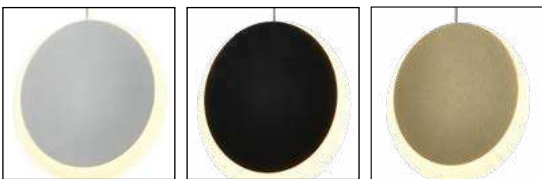

PD1652BR

PD1652PT

PD1652PT



PD1654BR

PD1654PT

PD1654DO

Somut

Estrutura: Metal/ Concreto

PD1748: Concreto / Vidro

PD1756: Metal/ Concreto/ Acrílico

LANÇAMENTO 2022



● **PD1612**
Pendente

LED 4W
Lúmens: 300lm
Temperatura: 3000K
Dimensões: Ø45 x A400 mm
Tensão: Bivolt (127V/220V)
Potência máxima: 4W
Cabo 1500mm



● **PD1613**
Pendente

LED 4W
Lúmens: 300lm
Temperatura: 3000K
Dimensões: Ø70 mm
Tensão: Bivolt (127V/220V)
Potência máxima: 4W
Cabo 1500mm



● **PD1748**
Pendente

1xG9 LED 5W
Dimensões: Ø80 x A150 mm
Tensão: Bivolt (127V/220V)
Potência máxima: 5W
Cabo ajustável até 1500mm



● **PD1756**
Pendente

1xG9 LED 5W
Dimensões: Ø130 x A135 mm
Tensão: Bivolt (127V/220V)
Potência máxima: 5W
Cabo ajustável até 2000mm



PD1613

Dover

LANÇAMENTO 2022

Estrutura: Alumínio
Disco: Branco
Acabamento: Preto / Dourado



● PL1644PT

Plafon

LED 10.5W
Lúmens: 1100lm
Temperatura: 3000K
Dimensões: Ø300 x A223 mm
Tensão: Bivolt (127V/220V)
Potência máxima: 10.5W



● PD1643DO

Pendente

LED 10.5W
Lúmens: 1050lm
Temperatura: 3000K
Dimensões: Ø400 x A580 mm
Tensão: Bivolt (127V/220V)
Potência máxima: 10.5W
Cabo ajustável até 1500mm



PL1644DO

PL1644PT



PD1643DO

PD1643PT

Sonik

LANÇAMENTO 2022

Estrutura: Metal/Alumínio/ Acrílico

Acabamento: Dourado escovado ?



● AR1657DO

Arandela

LED 12W
Lúmens: 600lm
Temperatura: 3000K
Dimensões: C50 x A410 mm
Tensão: Bivolt (127V/220V)
Potência máxima: 12W

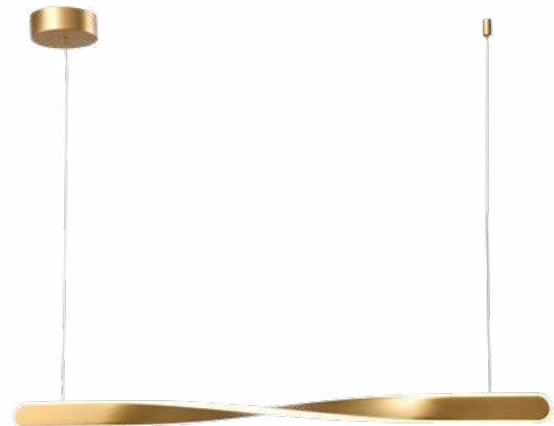

● PD1658DO

Pendente

LED 12W
Lúmens: 600lm
Temperatura: 3000K
Dimensões: C50 x A410 mm
Tensão: Bivolt (127V/220V)
Potência máxima: 12W
Cabo ajustável até 1500mm

● PD1659DO

Pendente

LED 29W
Lúmens: 1450lm
Temperatura: 3000K
Dimensões: C1010 x A50 mm
Tensão: Bivolt (127V/220V)
Potência máxima: 29W
Cabo ajustável até 1500mm

Spy

LANÇAMENTO 2022

Estrutura: Metal/vidro
Difusor: Difusor branco opalino
Acabamento: Preto ou dourado

Produto flexível na instalação

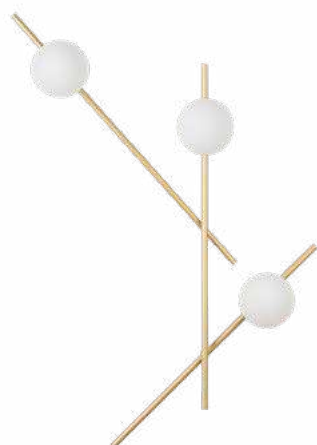

● **AR1726DO**
Arandela/Plafon

3x G9 5W
Dimensões: C815 x L635 x P150 mm
Tensão: Bivolt (127V/220V)
Potência máxima: 15W

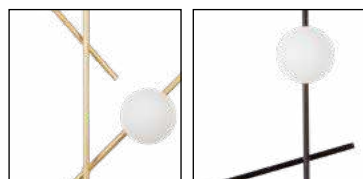

AR1726DO

AR1726PT

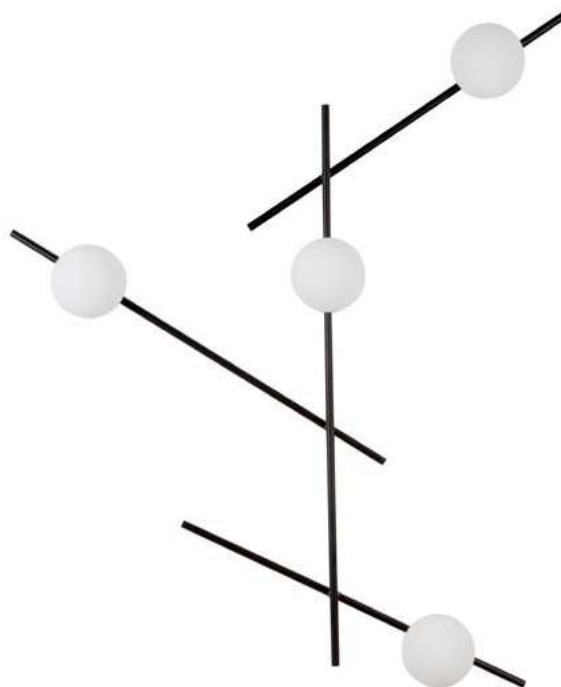

● **AR1727PT**
Arandela/Plafon

4x G9 5W
Dimensões: C920 x L780 x P150 mm
Tensão: Bivolt (127V/220V)
Potência máxima: 20W

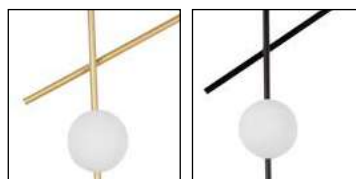

AR1727DO

AR1727PT



AR1727PT

Hazel

LANÇAMENTO 2022

Estrutura: Metal/cristal
Acabamento: Dourado



● **PD1699**
Pendente

LED 4W
Lúmens: 294lm
Temperatura: 3000K
Dimensões: Ø90 x A175 mm
Tensão: Bivolt (127V/220V)
Potência máxima: 4W
Cabo 1500mm

Horus

LANÇAMENTO 2022

Estrutura: Metal / Cristal

Difusor:

Acabamento: Dourado



● **AR1660**
Arandela

LED 3W
Lúmens: 120lm
Temperatura: 3000K
Dimensões: Ø105 x A118 mm
Tensão: Bivolt (127V/220V)
Potência máxima: 3W



● **PD1661**
Pendente

LED 3W
Lúmens: 120lm
Temperatura: 3000K
Dimensões: Ø105 x C1500 x A118 mm
Tensão: Bivolt (127V/220V)
Potência máxima: 3W
Cabo 1500mm

Berla

LANÇAMENTO 2022

Estrutura: Metal/acrílico

Acabamento: Branco

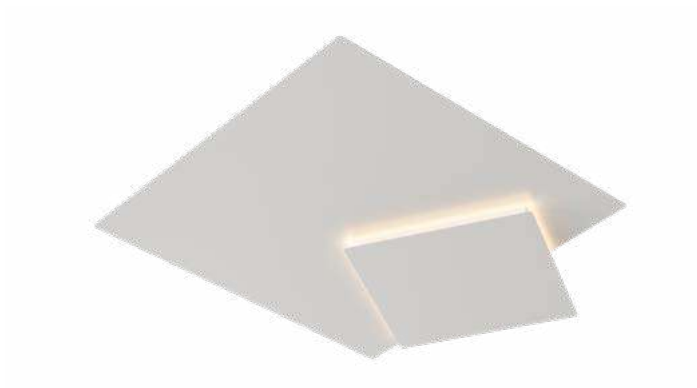

● **PL1749**

Plafon

LED 33W

Lúmens: 2376lm

Temperatura: 3000K

Dimensões: C620 x L500 x P50 mm

Tensão: Bivolt (127V/220V)

Potência máxima: 4W



● **PL1750**

Plafon

LED 31W

Lúmens: 2232lm

Temperatura: 3000K

Dimensões: C600 x L580 x P50 mm

Tensão: Bivolt (127V/220V)

Potência máxima: 4W

Space

LANÇAMENTO 2022

Estrutura: Metal / Plástico
Acabamento: Preto



● AR1703

Arandela

1x G9 40W
Dimensões: Ø293 x L95 x A355 mm
Tensão: Bivolt (127V/220V)
Potência máxima: 40W
Possui cabo de 1300mm com interruptor liga e desliga para ser ligado a tomada



● LM1702

Luminária de mesa

1x G9 40W
Dimensões: Ø305 x L180 x A430 mm
Tensão: Bivolt (127V/220V)
Potência máxima: 40W
Possui cabo de 1800mm com interruptor liga e desliga para ser ligado a tomada

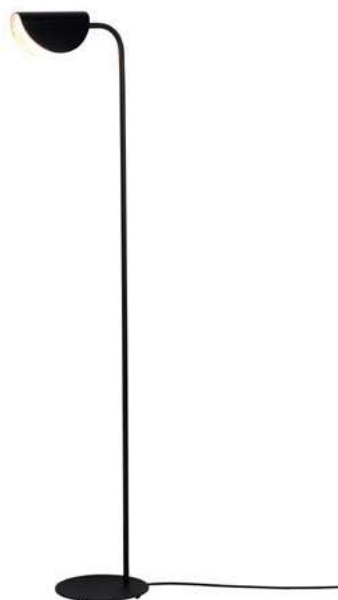

● CL1704

Coluna

1x G9 40W
Dimensões: Ø325 x L230 x A1400 mm
Tensão: Bivolt (127V/220V)
Potência máxima: 40W
Possui cabo de 2100mm com interruptor liga e desliga para ser ligado a tomada



CL1704

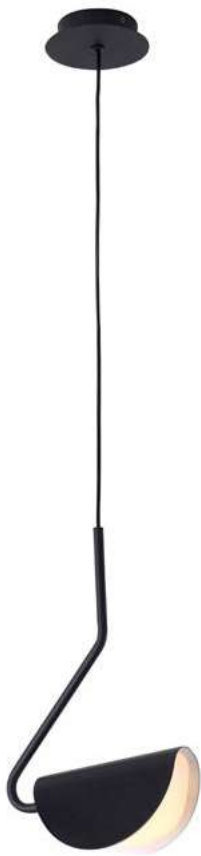

● **PD1705**
Pendente

1x G9 40W
Dimensões: Ø230 x L95 x A1500 mm
Tensão: Bivolt (127V/220V)
Potência máxima: 40W
Cabo 1500mm



● **PD1706**
Coluna

6x G9 40W
Dimensões: Ø1250 x A1030 mm
Tensão: Bivolt (127V/220V)
Potência máxima: 240W
Cabo 1500mm

Lamu

LANÇAMENTO 2022

Estrutura: Metal/ Acrílico / Poliestireno

Difusor: Branco

Acabamento: Branco



Luz indireta



● PD1751

Pendente

LED 3x11w + 3W

Lúmens:935lm

Potência: 2520k

Dimensões: D1000*H1200 x A1200 mm

Tensão: Bivolt (127V/220V)

Potência máxima: 36W

Cabo 1500mm

Ludo

LANÇAMENTO 2022

Estrutura: Alumínio
Difusor: Preto ou Dourado
Acabamento: Preto

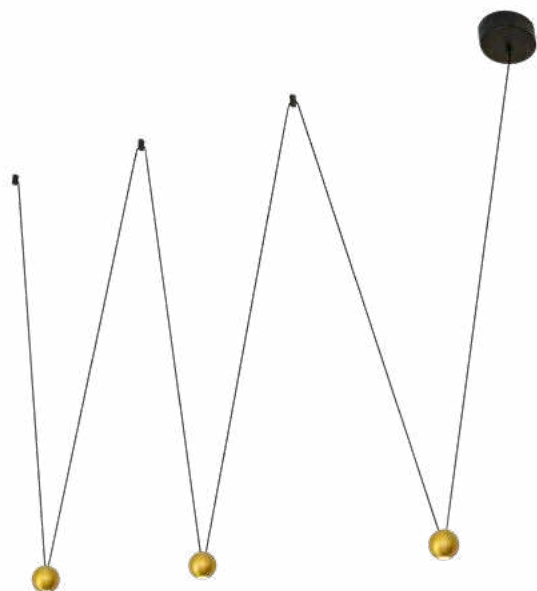

● **PD1645DO**
Pendente

LED 11W
Lúmens: 900lm
Temperatura: 3000K
Dimensões: Ø50 mm
Tensão: Bivolt (127V/220V)
Potência máxima: 11W
Cabo 1500mm



PD1645DO



PD1645PT

Pinot

LANÇAMENTO 2022

Estrutura: Metal/vidro

Difusor: Branco opalino fumê
champagne

Acabamento: Preto, branco ou dourado



● AR1670BR

Arandela

2x G9 5W

Dimensões: Ø330 x A460 mm

Tensão: Bivolt (127V/220V)

Potência máxima: 10W

● AR1671DO

Arandela

4x G9 5W

Dimensões: Ø400 x A950 mm

Tensão: Bivolt (127V/220V)

Potência máxima: 20W



AR1670BR



AR1670PT



AR1670DO



AR1671BR



AR1671PT

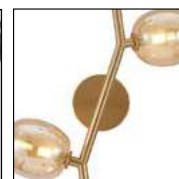

AR1671DO



AB1672PT



● **AB1672PT**

Arandela

2x G9 5W

Dimensões: Ø240 x A470 mm

Tensão: Bivolt (127V/220V)

Potência máxima: 10W

Possui cabo de 1700mm com interruptor liga e desliga para ser ligado a tomada



AB1672BR



AB1672PT



AB1672DO



● **CL1673DO**

Coluna

7x G9 5W

Dimensões: Ø370 x A1750 mm

Tensão: Bivolt (127V/220V)

Potência máxima: 35W

Possui cabo de 2050mm com interruptor liga e desliga para ser ligado a tomada

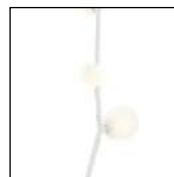

CL1673BR

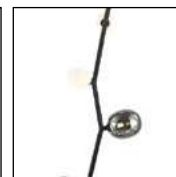

CL1673PT



CL1673DO

Pinot

LANÇAMENTO 2022

Estrutura: Metal/vidro

Difusor: Branco opalino fumê champagne

Acabamento: Preto, branco ou dourado

Duas opções de montagem*



● PD1674PT

Pendente

5x G9 5W

Dimensões: C1300 x L335 x A400 mm

Tensão: Bivolt (127V/220V)

Potência máxima: 25W

Cabo ajustável até 2000mm

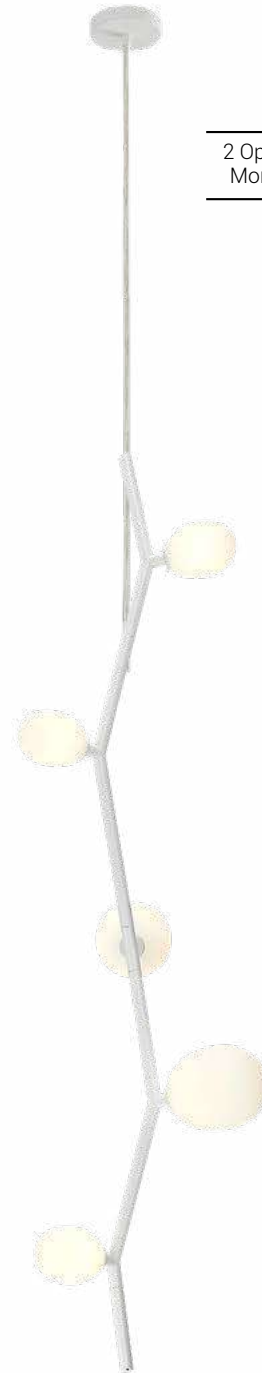

2 Opções de Montagem

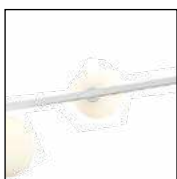

PD1674BR



PD1674PT

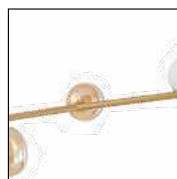

PD1674DO

*Para outra opção de montagem, remova o cabo de aço, mantendo o pendente na vertical



PD1674BR



2 Opções de Montagem



● **PD1675BR**
Pendente

7x G9 5W
Dimensões: C1750 x L335 x A400 mm
Tensão: Bivolt (127V/220V)
Potência máxima: 35W
Cabo ajustável até 2000mm

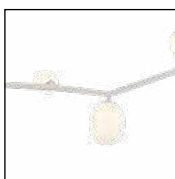

PD1675BR



PD1675PT

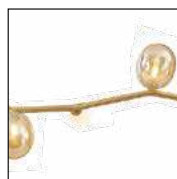

PD1675DO

*Para outra opção de montagem, remova o cabo de aço, mantendo o pendente na vertical

Bert

LANÇAMENTO 2022

Estrutura: Alumínio/ Silica gel

Acabamento: Preto, Branco ou Dourado



● PD1735PT

Pendente

LED 72W

Lúmens: 3240lm

Temperatura: 3000K

Dimensões: Ø600 + Ø800 x A15 mm

Tensão: Bivolt (127V/220V)

Potência máxima: 72W

Cabo ajustável até 1500mm



PD1735BR

PD1735PT

PD1735DO

Mob

LANÇAMENTO 2022

Estrutura: Metal/ Acrílico

Acabamento: Branco fosco / Preto fosco



● PL1663PT

Plafon

LED 24W

Lúmens: 1600lm

Temperatura: 3000K

Dimensões: C400 x L305 x A30 mm

Tensão: Bivolt (127V/220V)

Potência máxima: 18W



PL1663BR

PL1663PT

● PL1662BR

Plafon

LED 18W

Lúmens: 1200lm

Temperatura: 3000K

Dimensões: C300 x L210 x A30 mm

Tensão: Bivolt (127V/220V)

Potência máxima: 18W



PL1662BR

PL1662PT

Dupe

LANÇAMENTO 2022

Estrutura: Metal/ Acrílico

Acabamento: Branco



● **PL1664**
Plafon

LED 22W

Lúmens: 1500lm

Temperatura: 3000K

Dimensões: C545 x L405 x A50 mm

Tensão: Bivolt (127V/220V)

Potência máxima: 22W



Luft

LANÇAMENTO 2022

Estrutura: Metal/ Acrílico

Acabamento: Branco

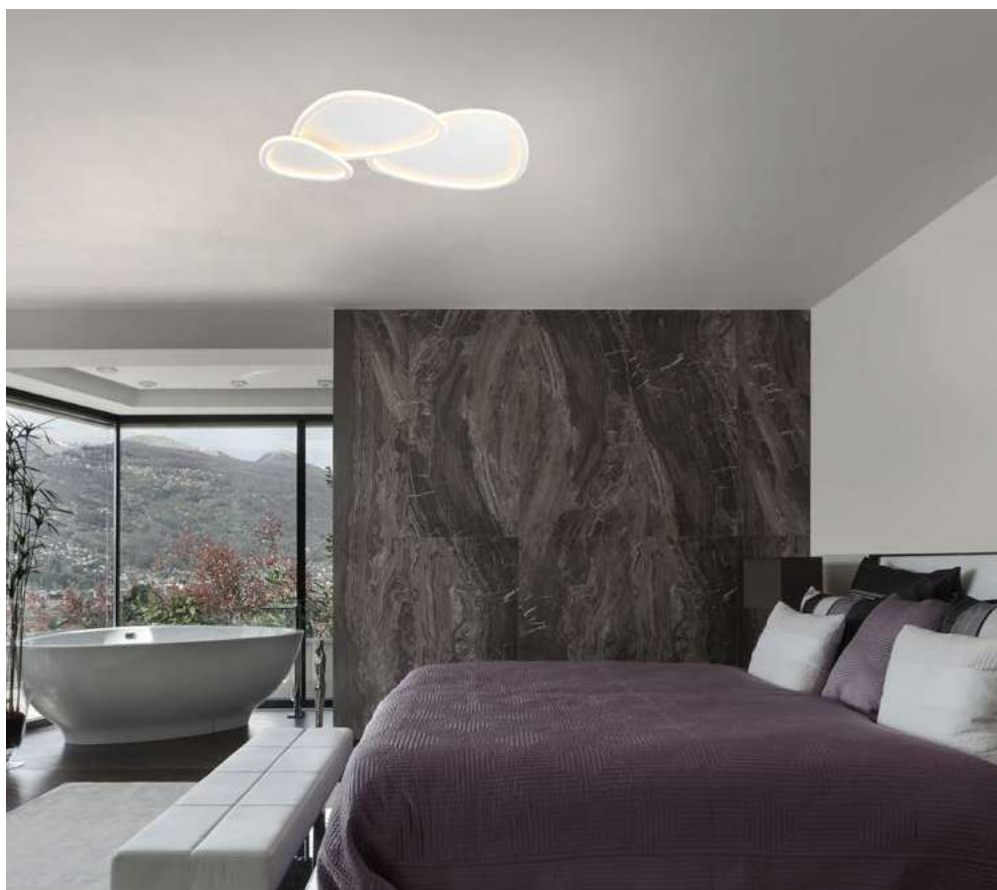

● **PL1666**

Plafon

LED 60W

Lúmens: 3900lm

Temperatura: 3000K

Dimensões: C750 x L500 x A80 mm

Tensão: Bivolt (127V/220V)

Potência máxima: 60W

Kane

LANÇAMENTO 2022

Estrutura: Metal/ Vidro/ Acrílico
Acabamento: Champagne ou fumê



● PD1667DO

Pendente

LED 7W
Lúmens: 400lm
Temperatura: 3000K
Dimensões: Ø380 x A170 mm
Tensão: Bivolt (127V/220V)
Potência máxima: 7W
Cabo ajustável até 1500mm



PD1667DO

PD1667OX



● PD1668DO

Pendente

LED 7W
Lúmens: 400lm
Temperatura: 3000K
Dimensões: Ø260 x A240 mm
Tensão: Bivolt (127V/220V)
Potência máxima: 7W
Cabo ajustável até 1500mm



PD1668DO

PD1668OX



PD1668DO

● **AB17360X**

Abajur

LED 7W

Lúmens: 400lm

Temperatura: 3000K

Dimensões: Ø220 x A520 mm

Tensão: Bivolt (127V/220V)

Potência máxima: 7W

Possui cabo de 1500mm com interruptor liga e desliga para ser ligado a tomada



PD1668DO



PD1668OX

Vermont

LANÇAMENTO 2022

Estrutura: Metal/ Vidro
Difusor: Cúpula branco opalino
Acabamento: Dourado



● PD1752

Pendente

2xG9 LED 5W
Dimensões: C432 x A275 mm
Tensão: Bivolt (127V/220V)
Potência máxima: 10W
Cabo ajustável até 1500mm



● PD1753

Pendente

1xG9 LED 5W
Dimensões: C222 x A180 mm
Tensão: Bivolt (127V/220V)
Potência máxima: 5W
Cabo ajustável até 1500mm



● PD1754

Pendente

3xG9 LED 5W
Dimensões: C1200 x A257 mm
Tensão: Bivolt (127V/220V)
Potência máxima: 15W
Cabo ajustável até 1500mm

Eden

LANÇAMENTO 2022

Estrutura: Metal/ Vidro
Cúpula: Cúpula Transparente /
Champagne / Fumê
Acabamento: Preto ou Dourado



● PD1755FM

Pendente

1xG9 LED 5W
Dimensões: Ø150 x A215 mm
Tensão: Bivolt (127V/220V)
Potência máxima: 5W
Cabo ajustável até 1500mm



PD1755TR
Vidro transparente

PD1755CH
Vidro champagne

PD1755FM
Vidro fumê



PD1755CH

Tera

LANÇAMENTO 2022

Estrutura: Metal/ Acrílico
Difusor: Branco opalino
Acabamento: Preto ou Dourado



● PD1757DO Pendente

1xG9 LED 5W
Dimensões: Ø160 x A530 mm
Tensão: Bivolt (127V/220V)
Potência máxima: 5W
Cabo ajustável até 1500mm



PD1757PT



PD1757DO

● AB1758PT Abajur

1xG9 LED 5W
Dimensões: Ø170 x A500 mm
Tensão: Bivolt (127V/220V)
Potência máxima: 5W
Possui cabo de 1500mm com interruptor liga e desliga para ser ligado a tomada



AB1758PT



AB1758DO

Ohana

LANÇAMENTO 2022

Estrutura: Metal / Vidro

Difusor: Fumê ou champagne

Acabamento: Dourado ou Preto (onix)



● **PD1684DO**
Pendente

LED 10W

Lúmens: 700lm

Temperatura: 3000K

Dimensões: Ø300 x A320 mm

Tensão: Bivolt (127V/220V)

Potência máxima: 10W

Cabo ajustável 1500mm



PD1684DO



PD1684OX

Luxor

LANÇAMENTO 2022

Estrutura: Metal / Cristal
Acabamento: Dourado



● **AR1676**
Arandela

LED 4W
Lúmens: 280lm
Temperatura: 3000K
Dimensões: C100 x L105 x A420 mm
Tensão: Bivolt (127V/220V)
Potência máxima: 4W

● **PD1677**
Pendente

LED 4W
Lúmens: 280lm
Temperatura: 3000K
Dimensões: Ø32 x A500 mm
Tensão: Bivolt (127V/220V)
Potência máxima: 4W
Cabo ajustável até 1500mm

Blasen

LANÇAMENTO 2022

Estrutura: Metal/Alumínio/ Vidro

Difusor: Fumê ou Champagne

Acabamento: Preto ou Dourado

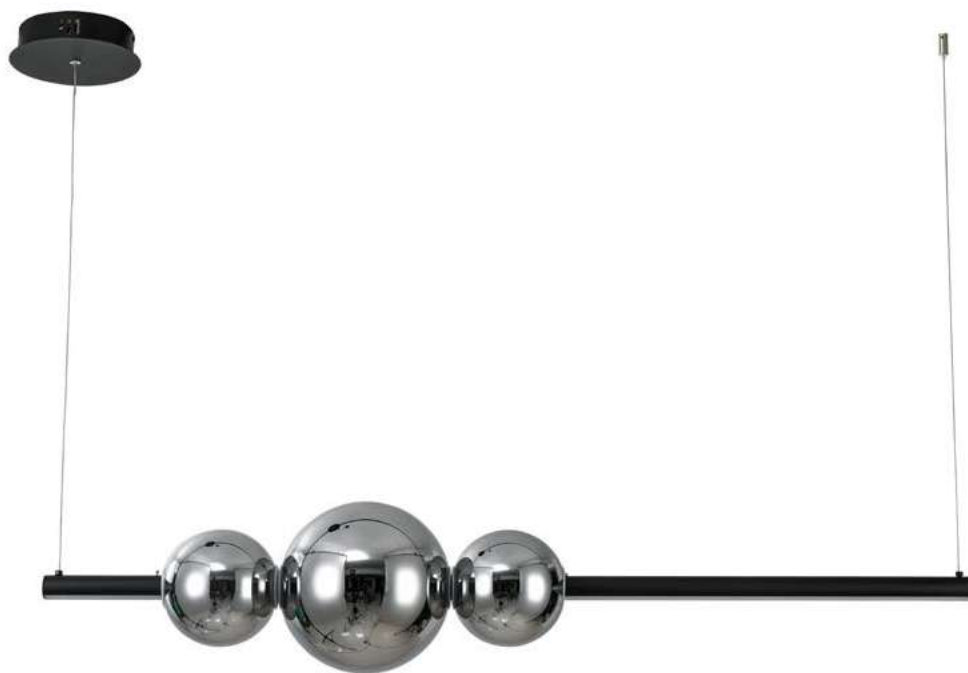

● PD1725PT

Pendente

LED 37W

Lúmens: 2300lm

Potência: 3000k

Dimensões: C1200 x L220 x A1650 mm

Tensão: Bivolt (127V/220V)

Potência máxima: 37W

Cabo 1500mm



PD1725DO



PD1725PT



PD1725PT

Linse

Estrutura: Metal/ Vidro/ Lente
Difusor: Vidro
Acabamento: Preto ou Dourado



LANÇAMENTO 2022

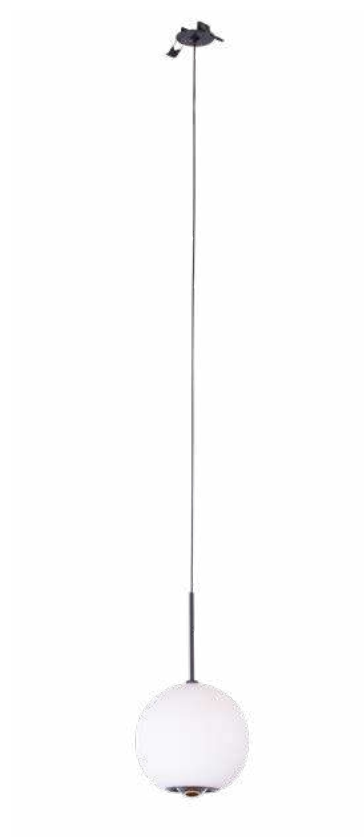

● PD1714PT

Pendente

LED 8W
Lúmens: 480lm
Temperatura: 3000K
Dimensões: Ø150 x L150 x A270 mm
Tensão: Bivolt (127V/220V)
Potência máxima: 8W
Cabo ajustável até 2000mm



PD1714PT



PD1714DO

Augen

LANÇAMENTO 2022

Estrutura: Metal/ Lente

Acabamento: Preto (Onix) ou Dourado

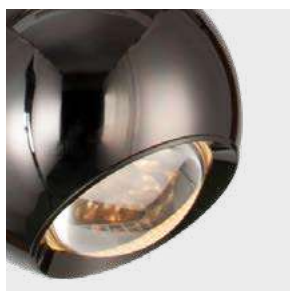

● **PD17210X**
Pendente

LED 7W
Lúmens: 420lm
Potência: 3000k
Dimensões: Ø120 x L120 x A240 mm
Tensão: Bivolt (127V/220V)
Potência máxima: 7W
Cabo 2000mm



PD17210X



PD1721DO

Gali

LANÇAMENTO 2022

Estrutura: Metal / Alumínio/ Acrílico
Acabamento: Dourado ou Preto (Onix)



● **PD1723DO**
Pendente

LED 5W
Lúmens: 300lm
Temperatura: 3000K
Dimensões: Ø30 x L30 x A345 mm
Tensão: Bivolt (127V/220V)
Potência máxima: 5W
Cabo 2000mm

● **PD1724OX**
Pendente

LED 13W
Lúmens: 780lm
Temperatura: 3000K
Dimensões: Ø150 x L150 x A345 mm
Tensão: Bivolt (127V/220V)
Potência máxima: 13W
Cabo 2000mm



PD1723OX

PD1723DO

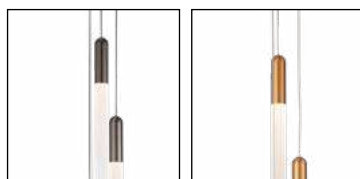

PD1724OX

PD1724DO



PD17240X

Orbit Mondri

LANÇAMENTO 2022

Estrutura: Alumínio/cúpula de vidro
Difusor: Opalino, Champagne ou Misto
(opalino interno e cristal externo)
Acabamento: Dourado fosco ou preto fosco

Canopla de 10cm (recomendado para
instalação em tetos/paredes de gesso)



● PLH1593PT

Plafon/Arandela

1x G9 HALOPIN LED 5W
Dimensões: C300 x L300 x A145 mm
Tensão: Bivolt (127V/220V)
Potência máxima: 5W

● PLH1593TRDO

Plafon/Arandela

1x G9 HALOPIN LED 5W
Dimensões: C300 x L300 x A145 mm
Tensão: Bivolt (127V/220V)
Potência máxima: 5W



PLH1593PT
1 esfera de 12cm

PLH1593TRPT
1 esfera de 12cm

PLH1593CHPT
1 esfera de 12cm

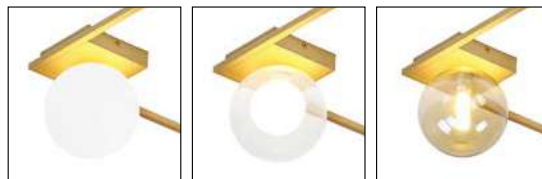

PLH1593DO
1 esfera de 12cm

PLH1593TRDO
1 esfera de 12cm

PLH1593CHDO
1 esfera de 12cm

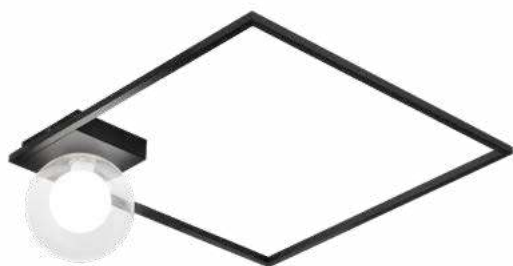

● **PLH1594TRPT**

Plafon/Arandela

1x G9 HALOPIN LED 5W
 Dimensões: C400 x L400 x A145 mm
 Tensão: Bivolt (127V/220V)
 Potência máxima: 5W

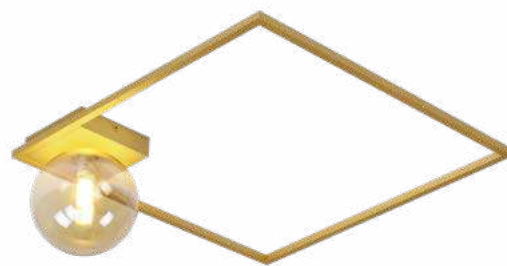

● **PLH1594CHDO**

Plafon/Arandela

1x G9 HALOPIN LED 5W
 Dimensões: C400 x L400 x A145 mm
 Tensão: Bivolt (127V/220V)
 Potência máxima: 5W



PLH1594PT
1 esfera de 12cm

PLH1594TRPT
1 esfera de 12cm

PLH1594CHPT
1 esfera de 12cm

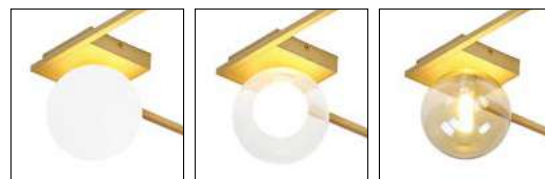

PLH1594DO
1 esfera de 12cm

PLH1594TRDO
1 esfera de 12cm

PLH1594CHDO
1 esfera de 12cm

Orbit Mondri

LANÇAMENTO 2022

Estrutura: Alumínio/cúpula de vidro
Difusor: Opalino, Champagne ou Misto
(opalino interno e cristal externo)
Acabamento: Dourado fosco ou preto fosco

- Canopla de 10cm (recomendado para instalação em tetos/paredes de gesso)
- Pode ser utilizado como plafon ou arandela
- Necessária ligação elétrica em todas as bases
- Acompanha 1 canopla para montagem de produtos sobrepostos

*A dimensão total da composição irá variar de acordo com a instalação

KIT COM 2 PEÇAS PARA MONTAGEM MODULAR

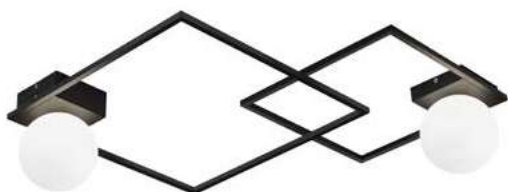
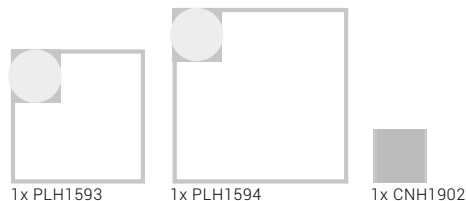

● PLH1595PT Plafon/Arandela

2x G9 HALOPIN LED 5W
Dimensões: * 1xPLH1593 C300 x L300 x A145 mm
+ 1xPLH1594 C400 x L400 x A145 mm
Tensão: Bivolt (127V/220V)
Potência máxima: 10W

● PLH1595TRDO Plafon/Arandela

2x G9 HALOPIN LED 5W
Dimensões: * 1xPLH1593 C300 x L300 x A145 mm
+ 1xPLH1594 C400 x L400 x A145 mm
Tensão: Bivolt (127V/220V)
Potência máxima: 10W



PLH1595PT
2 esferas de 12cm

PLH1595TRPT
2 esferas de 12cm

PLH1595CHPT
2 esferas de 12cm

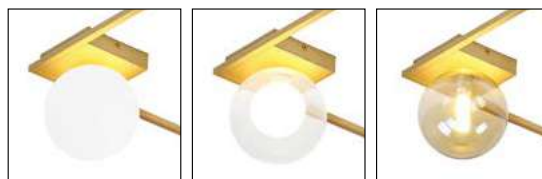

PLH1595DO
2 esferas de 12cm

PLH1595TRDO
2 esferas de 12cm

PLH1595CHDO
2 esferas de 12cm



PLH1595PT / PLH1595DO

Orbit Mondri

LANÇAMENTO 2022

Estrutura: Alumínio/cúpula de vidro
Difusor: Opalino, Champagne ou Misto
(opalino interno e cristal externo)
Acabamento: Dourado fosco ou preto fosco

- Canopla de 10cm (recomendado para instalação em tetos/paredes de gesso)
- Pode ser utilizado como plafon ou arandela



● PLH1596TRPT

Plafon/Arandela

1x G9 HALOPIN LED 5W
Dimensões: C500 x L120 x A145 mm
Tensão: Bivolt (127V/220V)
Potência máxima: 5W

● PLH1596CHDO

Plafon/Arandela

1x G9 HALOPIN LED 5W
Dimensões: C500 x L120 x A145 mm
Tensão: Bivolt (127V/220V)
Potência máxima: 5W



PLH1596PT
1 esfera de 12cm

PLH1596TRPT
1 esfera de 12cm

PLH1596CHPT
1 esfera de 12cm



PLH1596DO
1 esfera de 12cm

PLH1596TRDO
1 esfera de 12cm

PLH1596CHDO
1 esfera de 12cm



PLH1596PT



● **PLH1597CHPT**

Plafon/Arandela

1x G9 HALOPIN LED 5W
 Dimensões: C600 x L120 x A145 mm
 Tensão: Bivolt (127V/220V)
 Potência máxima: 5W

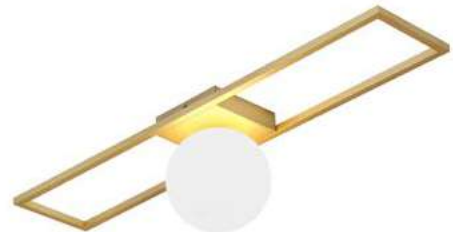

● **PLH1597DO**

Plafon/Arandela

1x G9 HALOPIN LED 5W
 Dimensões: C600 x L120 x A145 mm
 Tensão: Bivolt (127V/220V)
 Potência máxima: 5W



PLH1597PT
1 esfera de 12cm

PLH1597TRPT
1 esfera de 12cm

PLH1597CHPT
1 esfera de 12cm

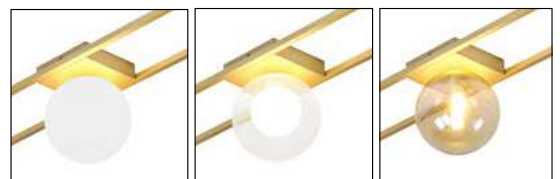

PLH1597DO
1 esfera de 12cm

PLH1597TRDO
1 esfera de 12cm

PLH1597CHDO
1 esfera de 12cm

Orbit Mondri

LANÇAMENTO 2022

Estrutura: Alumínio/cúpula de vidro
Difusor: Opalino, Champagne ou Misto
(opalino interno e cristal externo)
Acabamento: Dourado fosco ou preto fosco

- Canopla de 10cm (recomendado para instalação em tetos/paredes de gesso)
- Pode ser utilizado como plafon ou arandela
- Necessária ligação elétrica em todas as bases
- Acompanha 1 canopla para montagem de produtos sobrepostos

*A dimensão total da composição irá variar de acordo com a instalação

KIT COM 2 PEÇAS PARA MONTAGEM MODULAR

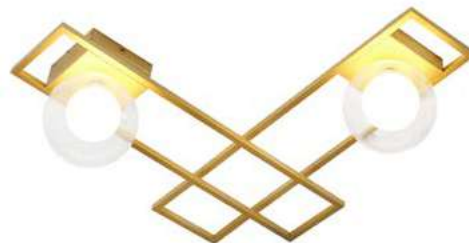
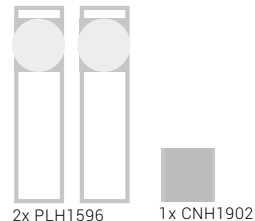

● PLH1598PT

Plafon/Arandela

2x G9 HALOPIN LED 5W

Dimensões: * 2xPLH1596 C500 x L120 x A145 mm

Tensão: Bivolt (127V/220V)

Potência máxima: 10W

● PLH1598TRDO

Plafon/Arandela

2x G9 HALOPIN LED 5W

Dimensões: * 2xPLH1596 C500 x L120 x A145 mm

Tensão: Bivolt (127V/220V)

Potência máxima: 10W



PLH1598PT
2 esferas de 12cm



PLH1598TRPT
2 esferas de 12cm



PLH1598CHPT
2 esferas de 12cm



PLH1598DO
2 esferas de 12cm



PLH1598TRDO
2 esferas de 12cm



PLH1598CHDO
2 esferas de 12cm

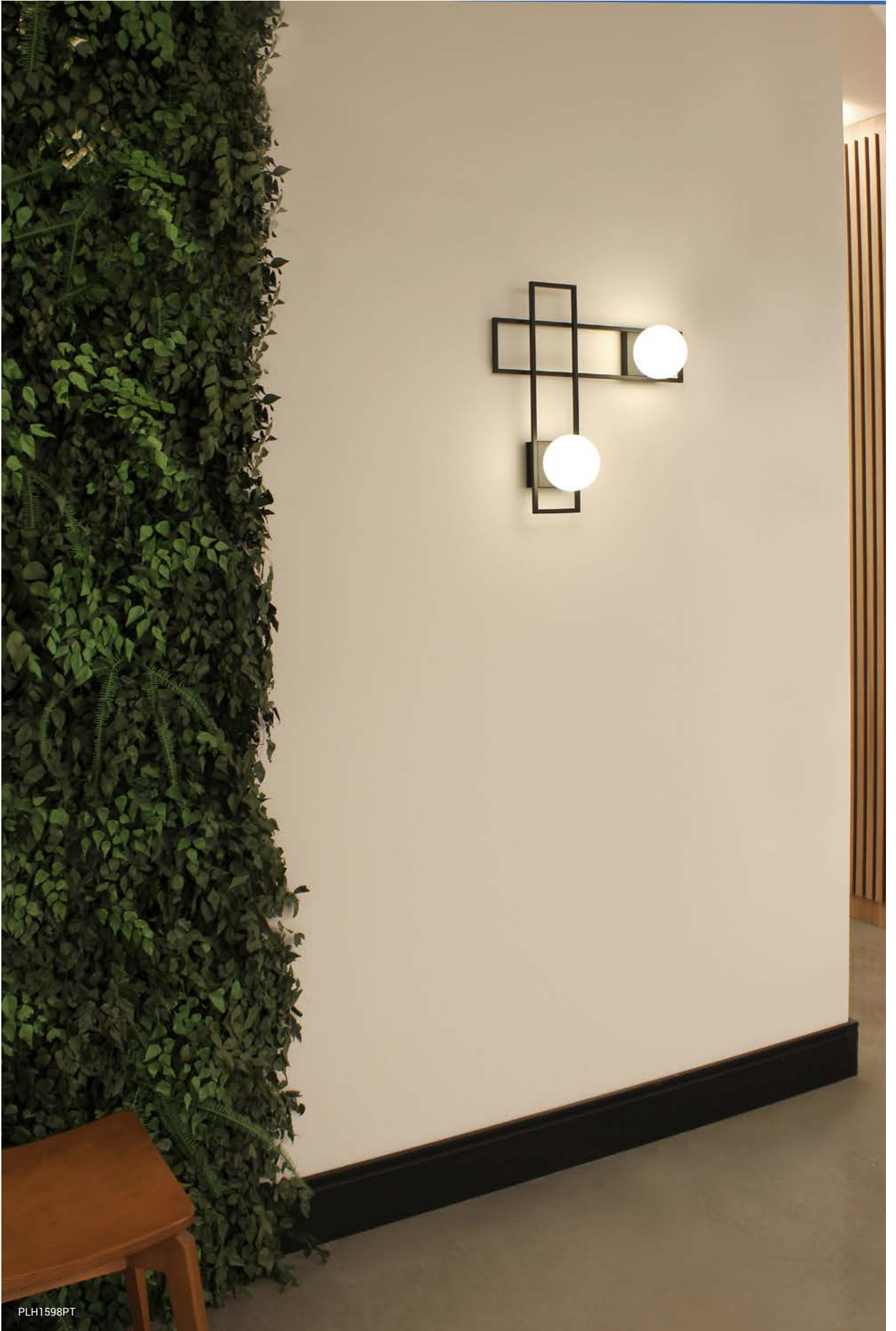

PLH1598PT

Orbit Mondri

LANÇAMENTO 2022

Estrutura: Alumínio/cúpula de vidro
Difusor: Opalino, Champagne ou Misto
(opalino interno e cristal externo)
Acabamento: Dourado fosco ou preto fosco

- Canopla de 10cm (recomendado para instalação em tetos/paredes de gesso)
- Pode ser utilizado como plafon ou arandela
- Necessária ligação elétrica em todas as bases
- Acompanha 1 canopla para montagem de produtos sobrepostos

*A dimensão total da composição irá variar de acordo com a instalação

KIT COM 3 PEÇAS PARA MONTAGEM MODULAR



● PLH1905TRPT

Plafon/Arandela

3x G9 HALOPIN LED 5W

Dimensões: * 2xPLH1596 C500 x L120 x A145 mm

+ 1xPLH1597 C600 x L120 x A145 mm

Tensão: Bivolt (127V/220V)

Potência máxima: 15W

● PLH1905DO

Plafon/Arandela

3x G9 HALOPIN LED 5W

Dimensões: * 2xPLH1596 C500 x L120 x A145 mm

+ 1xPLH1597 C600 x L120 x A145 mm

Tensão: Bivolt (127V/220V)

Potência máxima: 15W



PLH1905PT
3 esferas de 12cm

PLH1905TRPT
3 esferas de 12cm

PLH1905CHPT
3 esferas de 12cm



PLH1905DO
3 esferas de 12cm

PLH1905TRDO
3 esferas de 12cm

PLH1905CHDO
3 esferas de 12cm

CANOPLA PARA MONTAGEM DE CONJUNTOS

Necessário quando é realizada a montagem de composições de peças sobrepostas com utilização de produtos vendidos individualmente (item já incluso nos kits de montagens vendidos com duas ou mais peças)

- Produzido em alumínio
- Acabamentos dourado ou preto



CNH1902PT

Material: Estrutura em alumínio
Cor: Preta
Dimensões: C10 x L10 x A3,8cm



CNH1902DO

Material: Estrutura em alumínio
Cor: Dourada
Dimensões: C10 x L10 x A3,8cm

Orbit Mondri

LANÇAMENTO 2022

Estrutura: Alumínio/cúpula de vidro
Difusor: Opalino, Champagne ou Misto
(opalino interno e cristal externo)
Acabamento: Dourado fosco ou preto fosco

- Canopla de 10cm (recomendado para instalação em tetos/paredes de gesso)
- Pode ser utilizado como plafon ou arandela



ARH1599DO



● ARH1599PT Plafon/Arandela

1x G9 HALOPIN LED 5W
Dimensões: C130 x L120 x A130 mm
Tensão: Bivolt (127V/220V)
Potência máxima: 5W

● ARH1599DO Plafon/Arandela

1x G9 HALOPIN LED 5W
Dimensões: C130 x L120 x A130 mm
Tensão: Bivolt (127V/220V)
Potência máxima: 5W



ARH1599PT
1 esfera de 12cm

ARH1599TRPT
1 esfera de 12cm

ARH1599CHPT
1 esfera de 12cm



ARH1599DO
1 esfera de 12cm

ARH1599TRDO
1 esfera de 12cm

ARH1599CHDO
1 esfera de 12cm

Orbit Mondri

LANÇAMENTO 2022

Estrutura: Alumínio/cúpula de vidro
Difusor: Opalino, Champagne ou Misto
(opalino interno e cristal externo)
Acabamento: Dourado fosco ou preto
fosco

- Canopla de 10cm (recomendado para instalação em tetos/paredes de gesso)
- Pode ser utilizado como plafon ou arandela
- Necessária ligação elétrica em todas as bases

***A dimensão total da composição irá variar de acordo com a instalação**

KIT COM 2 PEÇAS PARA MONTAGEM MODULAR



● ARH1903CHPT

Plafon/Arandela

2x G9 HALOPIN LED 5W

Dimensões: * 2xARH1599 C130 x L120 x A130 mm

Tensão: Bivolt (127V/220V)

Potência máxima: 10W

● ARH1903DO

Plafon/Arandela

2x G9 HALOPIN LED 5W

Dimensões: * 2xARH1599 C130 x L120 x A130 mm

Tensão: Bivolt (127V/220V)

Potência máxima: 10W



ARH1903PT
2 esferas de 12cm

ARH1903TRPT
2 esferas de 12cm

ARH1903CHPT
2 esferas de 12cm



ARH1903DO
2 esferas de 12cm

ARH1903TRDO
2 esferas de 12cm

ARH1903CHDO
2 esferas de 12cm

Orbit Mondri

LANÇAMENTO 2022

Estrutura: Alumínio/cúpula de vidro
Difusor: Opalino, Champagne ou Misto
(opalino interno e cristal externo)
Acabamento: Dourado fosco ou preto fosco

- Canopla de 10cm (recomendado para instalação em tetos/paredes de gesso)
- Pode ser utilizado como plafon ou arandela
- Necessária ligação elétrica em todas as bases

*A dimensão total da composição irá variar de acordo com a instalação

KIT COM 4 PEÇAS PARA MONTAGEM MODULAR



4x ARH1599



● ARH1904PT

Plafon/Arandela

4x G9 HALOPIN LED 5W

Dimensões: * 4xARH1599 C130 x L120 x A130 mm

Tensão: Bivolt (127V/220V)

Potência máxima: 20W



● ARH1904TRDO

Plafon/Arandela

4x G9 HALOPIN LED 5W

Dimensões: * 4xARH1599 C130 x L120 x A130 mm

Tensão: Bivolt (127V/220V)

Potência máxima: 20W



ARH1904PT
4 esfera de 12cm



ARH1904TRPT
4 esfera de 12cm



ARH1904CHPT
4 esfera de 12cm



ARH1904DO
4 esfera de 12cm



ARH1904TRDO
4 esfera de 12cm



ARH1904CHDO
4 esfera de 12cm

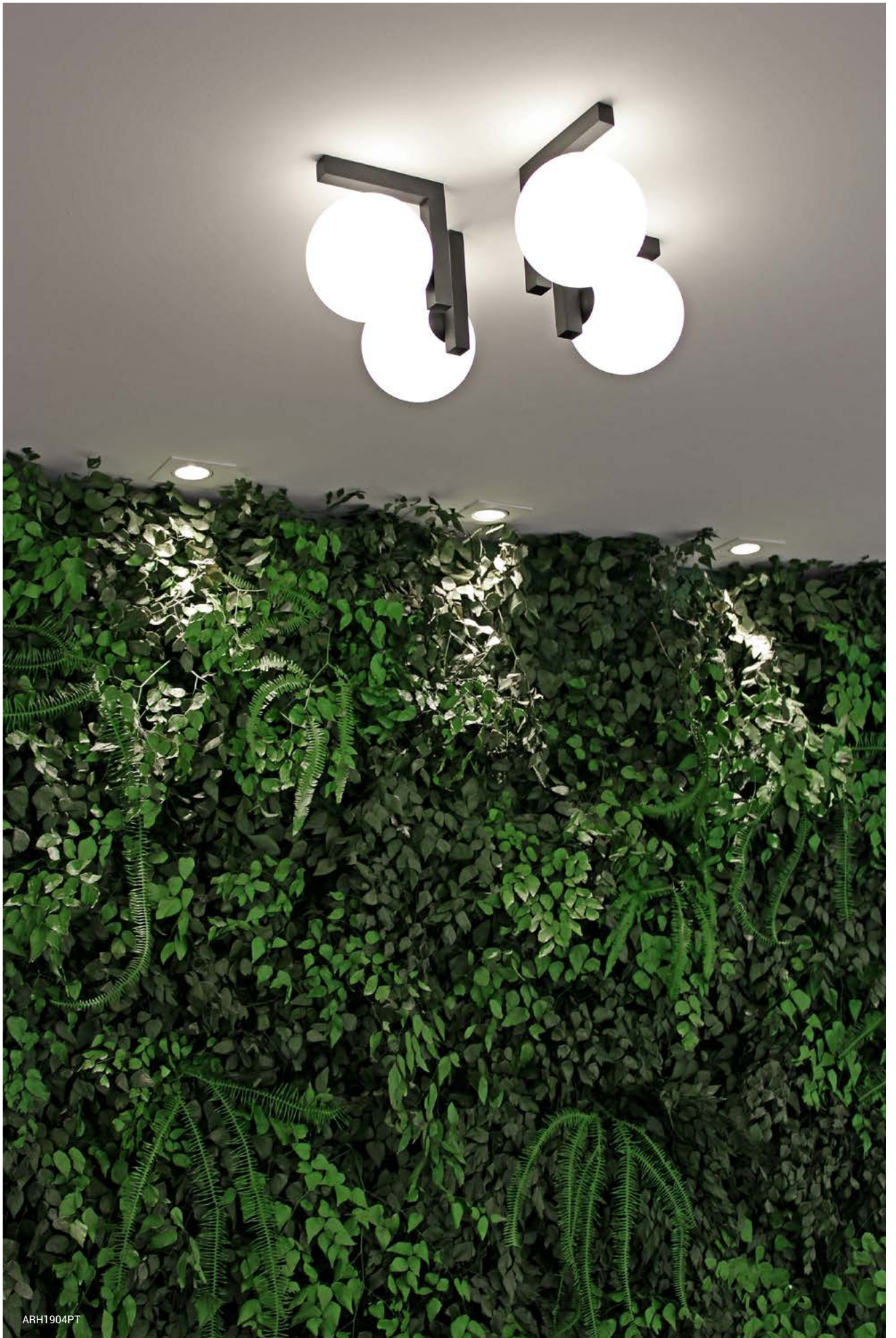

ARH1904PT

Orbit

Estrutura: Alumínio/cúpula de vidro
 Difusor: Opalino, Champagne ou Mistó
 (opalino interno e cristal externo)
 Acabamento: Dourado fosco ou preto fosco

- Canopla para instalação em forros de gesso
- Compatível com tampa de caixa de passagem NAC00137 para instalação em lajes (vendida separadamente)

*A dimensão total do produto irá variar de acordo com a esfera utilizada



● PDH1527PT

Pendente

6xG9 HALOPIN LED 5W
 Dimensões: C1050 x L265 x A160 mm
 Tensão: Bivolt (127V/220V)
 Potência máxima: 30W
 Cabo ajustável até 1500mm



PDH1527PT



● PDH1527DO

Pendente

6xG9 HALOPIN LED 5W
 Dimensões: C1050 x L265 x A160 mm
 Tensão: Bivolt (127V/220V)
 Cabo ajustável até 1500mm

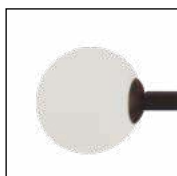

PDH1527PT
 2 esferas de 10cm e
 4 esferas de 12cm



PDH1527TRPT
 *6 esferas de 12cm



PDH1527CHPT
 2 esferas de 10cm e
 4 esferas de 12cm



PDH1527DO
 2 esferas de 10cm e
 4 esferas de 12cm



PDH1527TRDO
 *6 esferas de 12cm



PDH1527CHDO
 2 esferas de 10cm e
 4 esferas de 12cm



PDH1576DO



● **PDH1576CHDO**

Pendente

8xG9 HALOPIN LED 5W
 Dimensões: C1450 x L265 x A170 mm
 Tensão: Bivolt (127V/220V)
 Potência máxima: 40W
 Cabo ajustável até 1500mm



● **PDH1576PT**

Pendente

8xG9 HALOPIN LED 5W
 Dimensões: C1450 x L265 x A170 mm
 Tensão: Bivolt (127V/220V)
 Potência máxima: 40W
 Cabo ajustável até 1500mm



PDH1576PT
8 esferas de 12cm



PDH1576TRPT
8 esferas de 12cm

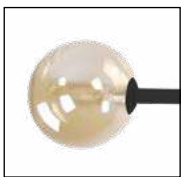

PDH1576CHPT
8 esferas de 12cm



PDH1576DO
8 esferas de 12cm



PDH1576TRDO
8 esferas de 12cm



PDH1576CHDO
8 esferas de 12cm

Orbit

Estrutura: Alumínio/cúpula de vidro
Difusor: Opalino, Champagne ou Misto
(opalino interno e cristal externo)
Acabamento: Dourado fosco ou preto fosco

Canopla compatível com instalação em lajes
(caixa de passagem)

***A dimensão total do produto irá variar de acordo com a esfera utilizada**

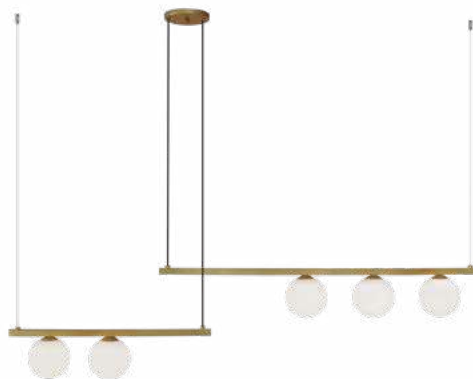

● PDH1528PT

Pendente

5xG9 HALOPIN LED 5W
Dimensões: C1185 x L120 x A140 mm
Tensão: Bivolt (127V/220V)
Potência máxima: 25W
Cabo ajustável até 1500mm

● PDH1528DO

Pendente

5xG9 HALOPIN LED 5W
Dimensões: C1185 x L120 x A140 mm
Tensão: Bivolt (127V/220V)
Potência máxima: 25W
Cabo ajustável até 1500mm



PDH1528PT

*5 esferas de 10cm

PDH1528TRPT

5 esferas de 12cm

PDH1528CHPT

5 esferas de 10cm

PDH1528DO

*5 esferas de 10cm

PDH1528TRDO

5 esferas de 12cm

PDH1528CHDO

5 esferas de 10cm



PDH1528TRDO

Orbit

Estrutura: Alumínio/cúpula de vidro
Difusor: Opalino, Champagne ou Misto
(opalino interno e cristal externo)
Acabamento: Dourado fosco ou preto fosco

.....
Ideal para instalação em paredes drywall



ARH1535TRDO



● ARH1535PT

Arandela

2xG9 HALOPIN LED 5W
Dimensões: C160 x L120 x A400 mm
Tensão: Bivolt (127V/220V)
Potência máxima: 10W



● ARH1535DO

Arandela

2xG9 HALOPIN LED 5W
Dimensões: C160 x L120 x A400 mm
Tensão: Bivolt (127V/220V)
Potência máxima: 10W



ARH1535PT

1 esfera de 10cm e
1 esfera de 12cm

ARH1535TRPT

1 esfera de 8cm e
1 esfera de 12cm

ARH1535CHPT

1 esfera de 10cm e
1 esfera de 12cm



ARH1535DO

1 esfera de 10cm e
1 esfera de 12cm

ARH1535TRDO

1 esfera de 8cm e
1 esfera de 12cm

ARH1535CHDO

1 esfera de 10cm e
1 esfera de 12cm



ARH1535PT

Orbit

Estrutura: Alumínio/cúpula de vidro
Difusor: Opalino, Champagne ou Misto
(opalino interno e cristal externo)
Acabamento: Dourado fosco ou preto fosco

Canopla compacta exclusiva para
forros de gesso



● PDH1530PT

Pendente

4xG9 HALOPIN LED 5W
Dimensões: C260 x L200 x A4750 mm
Tensão: Bivolt (127V/220V)
Potência máxima: 20W
Cabo ajustável até 1500mm

● PDH1530DO

Pendente

4xG9 HALOPIN LED 5W
Dimensões: C260 x L200 x A4750 mm
Tensão: Bivolt (127V/220V)
Potência máxima: 20W
Cabo ajustável até 1500mm

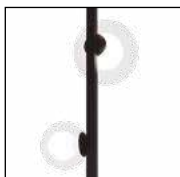
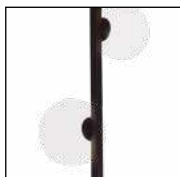

PDH1530PT

2 esferas de 8cm,
1 esfera de 10cm e
esfera de 12cm

PDH1530TRPT

2 esferas de 8cm e
2 esferas de 12cm

PDH1530CHPT

2 esferas de 10cm e
2 esferas de 12cm

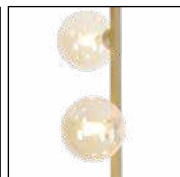
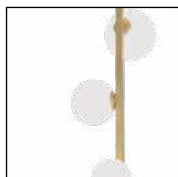

PDH1530DO

2 esferas de 8cm,
1 esfera de 10cm e
esfera de 12cm

PDH1530TRDO

2 esferas de 8cm e
2 esferas de 12cm

PDH1530CHDO

2 esferas de 10cm e
2 esferas de 12cm



PDH1530TRPT

Orbit

Estrutura: Alumínio/cúpula de vidro
Difusor: Opalino, Champagne ou Misto
(opalino interno e cristal externo)
Acabamento: Dourado fosco ou preto fosco

- Canopla para instalação em forros de gesso
- Compatível com tampa de caixa de passagem NAC00137 para instalação em lajes (vendida separadamente)

***A dimensão total do produto irá variar de acordo com a esfera utilizada**



PDH1532DO



● PDH1532PT

Pendente

1xG9 HALOPIN LED 5W
Dimensões: C180 x L100 x A280 mm
Tensão: Bivolt (127V/220V)
Potência máxima: 5W
Cabo ajustável até 1500mm

● PDH1532CHDO

Pendente

1xG9 HALOPIN LED 5W
Dimensões: C180 x L100 x A280 mm
Tensão: Bivolt (127V/220V)
Potência máxima: 5W
Cabo ajustável até 1500mm



PDH1532PT
1 esfera de 10cm

PDH1532TRPT
*1 esfera de 12cm

PDH1532CHPT
1 esfera de 10cm



PDH1532DO
1 esfera de 10cm

PDH1532TRDO
*1 esfera de 12cm

PDH1532CHDO
1 esfera de 10cm



PDH1533TRPT



● **PDH1533PT**

Pendente

2xG9 HALOPIN LED 5W
 Dimensões: C260 x L120 x A260 mm
 Tensão: Bivolt (127V/220V)
 Potência máxima: 10W
 Cabo ajustável até 1500mm



● **PDH1533DO**

Pendente

2xG9 HALOPIN LED 5W
 Dimensões: C260 x L120 x A260 mm
 Tensão: Bivolt (127V/220V)
 Potência máxima: 10W
 Cabo ajustável até 1500mm



PDH1533PT
 1 esfera de 10cm e
 esfera de 12cm



PDH1533TRPT
 1 esfera de 8cm e
 esfera de 12cm

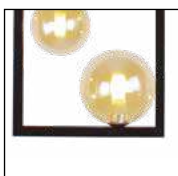

PDH1533CHPT
 1 esfera de 10cm e
 esfera de 12cm

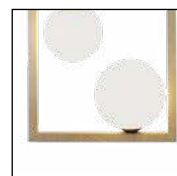

PDH1533DO
 1 esfera de 10cm e
 esfera de 12cm

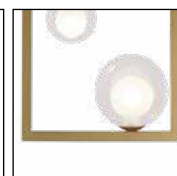

PDH1533TRDO
 1 esfera de 8cm e
 esfera de 12cm



PDH1533CHDO
 1 esfera de 10cm e
 esfera de 12cm

Orbit

Estrutura: Alumínio/cúpula de vidro
Difusor: Opalino, Champagne ou Mistó
(opalino interno e cristal externo)
Acabamento: Dourado fosco ou preto fosco

- Canopla para instalação em forros de gesso
- Compatível com tampa de caixa de passagem NAC00137 para instalação em lajes (vendida separadamente)

***A dimensão total do produto irá variar de acordo com a esfera utilizada**



● PDH1556PT

Pendente

3xG9 HALOPIN LED 5W
Dimensões: C600 x L100 x A305 mm
Tensão: Bivolt (127V/220V)
Potência máxima: 15W
Cabo ajustável até 1500mm



PDH1556TRPT



● PDH1556DO

Pendente

3xG9 HALOPIN LED 5W
Dimensões: C600 x L100 x A305 mm
Tensão: Bivolt (127V/220V)
Potência máxima: 15W
Cabo ajustável até 1500mm



PDH1556PT
3 esferas de 10cm



PDH1556TRPT
*3 esferas de 12cm



PDH1556CHPT
3 esferas de 10cm

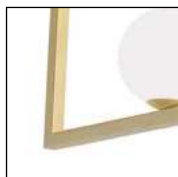

PDH1556DO
3 esferas de 10cm

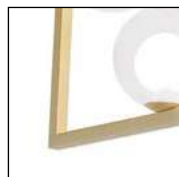

PDH1556TRDO
*3 esferas de 12cm



PDH1556CHDO
3 esferas de 10cm



PDH1557PT



● **PDH1557PT**

Pendente

3xG9 HALOPIN LED 5W

Dimensões: C300 x L100 x A605 mm

Tensão: Bivolt (127V/220V)

Potência máxima: 15W

Cabo ajustável até 1500mm

● **PDH1557DO**

Pendente

3xG9 HALOPIN LED 5W

Dimensões: C300 x L100 x A605 mm

Tensão: Bivolt (127V/220V)

Potência máxima: 15W

Cabo ajustável até 1500mm

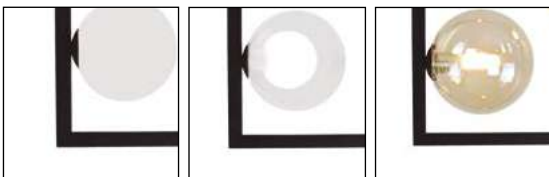

PDH1557PT
3 esferas de 10cm

PDH1557TRPT
*3 esferas de 12cm

PDH1557CHPT
3 esferas de 10cm



PDH1557DO
3 esferas de 10cm

PDH1557TRDO
*3 esferas de 12cm

PDH1557CHDO
3 esferas de 10cm

Orbit II

Estrutura: Alumínio/cúpula de vidro
Difusor: Opalino, Champagne ou Misto
(opalino interno e cristal externo)
Acabamento: Dourado fosco ou preto fosco

- Canopla para instalação em forros de gesso
- Compatível com tampa de caixa de passagem NAC00137 para instalação em lajes (vendida separadamente)

***A dimensão total do produto irá variar de acordo com a esfera utilizada**



● PDH1552TRPT

Pendente

1xG9 HALOPIN LED 5W
Dimensões: C100 x L100 x A250 mm
Tensão: Bivolt (127V/220V)
Potência máxima: 5W
Cabo ajustável até 1500mm



PDH1552PT
1 esfera de 10cm

PDH1552TRPT
*1 esfera de 12cm

PDH1552CHPT
1 esfera de 10cm



● PDH1552DO

Pendente

1xG9 HALOPIN LED 5W
Dimensões: C100 x L100 x A250 mm
Tensão: Bivolt (127V/220V)
Potência máxima: 5W
Cabo ajustável até 1500mm



PDH1552DO
1 esfera de 10cm

PDH1552TRDO
*1 esfera de 12cm

PDH1552CHDO
1 esfera de 10cm



PDH1552D0

Orbit II

Estrutura: Alumínio/cúpula de vidro
Difusor: Opalino, Champagne ou Misto
(opalino interno e cristal externo)
Acabamento: Dourado fosco ou preto fosco

- Canopla para instalação em forros de gesso
- Compatível com tampa de caixa de passagem NAC00137 para instalação em lajes (vendida separadamente)

***A dimensão total do produto irá variar de acordo com a esfera utilizada**

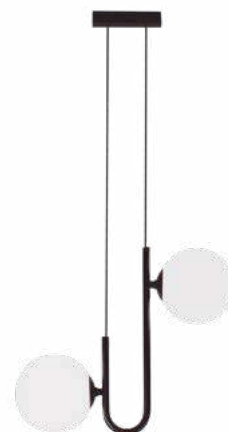

● PDH1553PT

Pendente

2xG9 HALOPIN LED 5W
Dimensões: C280 x L100 x A250 mm
Tensão: Bivolt (127V/220V)
Potência máxima: 10W
Cabo ajustável até 1500mm



PDH1553PT



● PDH1553CHDO

Pendente

2xG9 HALOPIN LED 5W
Dimensões: C280 x L100 x A250 mm
Tensão: Bivolt (127V/220V)
Potência máxima: 10W
Cabo ajustável até 1500mm

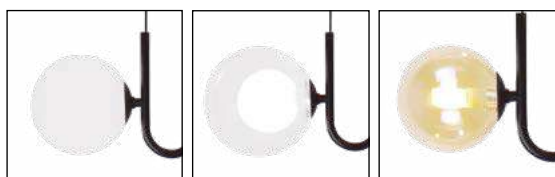

PDH1553PT
2 esferas de 10cm

PDH1553TRPT
*2 esferas de 12cm

PDH1553CHPT
2 esferas de 10cm

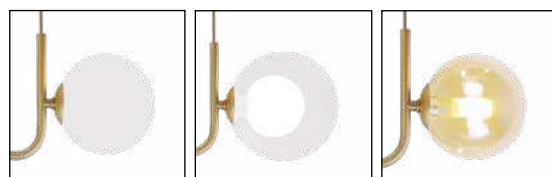

PDH1553DO
2 esferas de 10cm

PDH1553TRDO
*2 esferas de 12cm

PDH1553CHDO
2 esferas de 10cm



Canopla compacta exclusiva para forros de gesso



PDH1554TRDO

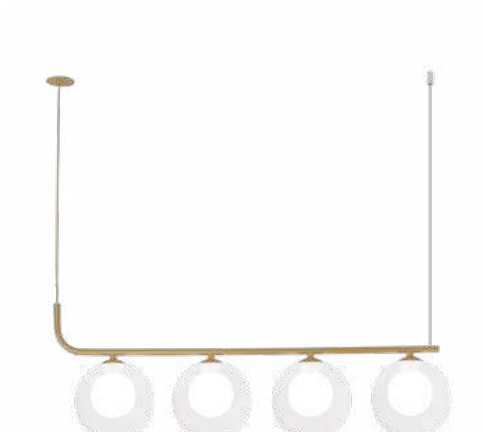
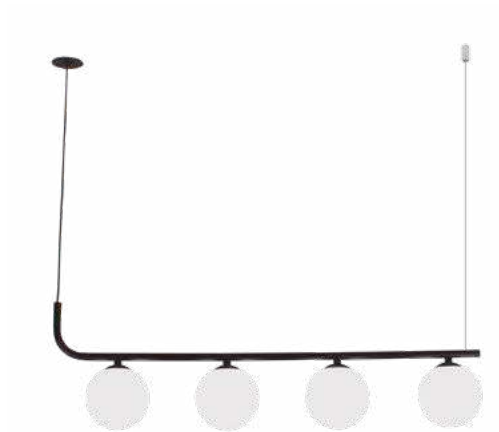

● **PDH1554PT**

Pendente

4xG9 HALOPIN LED 5W
 Dimensões: C700 x L100 x A210 mm
 Tensão: Bivolt (127V/220V)
 Potência máxima: 20W
 Cabo ajustável até 1500mm

● **PDH1554TRDO**

Pendente

4xG9 HALOPIN LED 5W
 Dimensões: C700 x L100 x A210 mm
 Tensão: Bivolt (127V/220V)
 Potência máxima: 20W
 Cabo ajustável até 1500mm



PDH1554PT
4 esferas de 10cm

PDH1554TRPT
*4 esferas de 12cm

PDH1554CHPT
4 esferas de 10cm

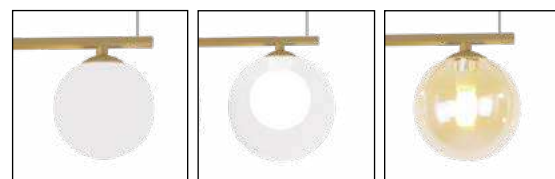

PDH1554DO
4 esferas de 10cm

PDH1554TRDO
*4 esferas de 12cm

PDH1554CHDO
4 esferas de 10cm

Orbit II

Estrutura: Alumínio/cúpula de vidro
Difusor: Opalino, Champagne ou Misto
(opalino interno e cristal externo)
Acabamento: Dourado fosco ou preto fosco

Canopla compacta exclusiva para forros de gesso

***A dimensão total do produto irá variar de acordo com a esfera utilizada**

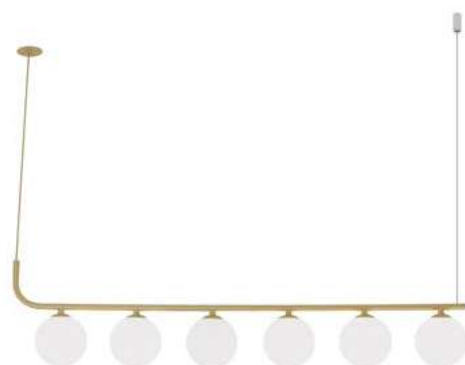
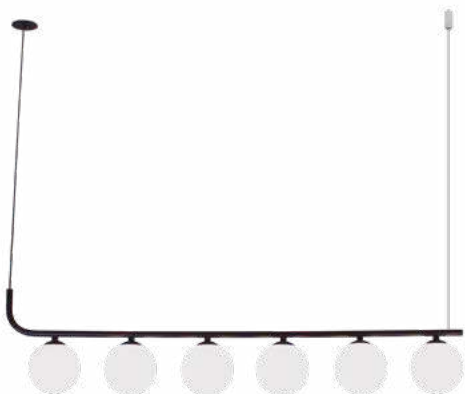

● PDH1555PT

Pendente

6xG9 HALOPIN LED 5W
Dimensões: C900 x L100 x A210 mm
Tensão: Bivolt (127V/220V)
Potência máxima: 30W
Cabo ajustável até 1500mm

● PDH1555DO

Pendente

6xG9 HALOPIN LED 5W
Dimensões: C900 x L100 x A210 mm
Tensão: Bivolt (127V/220V)
Potência máxima: 30W
Cabo ajustável até 1500mm



PDH1555PT
6 esferas de 10cm

PDH1555TRPT
*6 esferas de 12cm

PDH1555CHPT
6 esferas de 10cm



PDH1555DO
6 esferas de 10cm

PDH1555TRDO
*6 esferas de 12cm

PDH1555CHDO
6 esferas de 10cm



PDH1555PT

Orbit II

Estrutura: Alumínio/cúpula de vidro
Difusor: Opalino, Champagne ou Misto
(opalino interno e cristal externo)
Acabamento: Dourado fosco ou preto fosco

Canopla compacta exclusiva para
forros de gesso



● PDH1579TRPT

Pendente

5xG9 HALOPIN LED 5W
Dimensões: C1100 x L120 x A400 mm
Tensão: Bivolt (127V/220V)
Potência máxima: 25W
Cabo ajustável até 1500mm



● PDH1579DO

Pendente

5xG9 HALOPIN LED 5W
Dimensões: C900 x L100 x A4210 mm
Tensão: Bivolt (127V/220V)
Potência máxima: 25W
Cabo ajustável até 1500mm



PDH1579PT

3 esferas de 10cm e
2 esferas de 12cm

PDH1579TRPT

3 esferas de 8cm e
2 esferas de 12cm

PDH1579CHPT

3 esferas de 10cm e
2 esferas de 12cm



PDH1579DO

3 esferas de 10cm e
2 esferas de 12cm

PDH1579DO

3 esferas de 8cm e
2 esferas de 12cm

PDH1579CHDO

3 esferas de 10cm e
2 esferas de 12cm



PDH1579D0

Orbit II

Estrutura: Alumínio/cúpula de vidro
Difusor: Opalino, Champagne ou Misto
(opalino interno e cristal externo)
Acabamento: Dourado fosco ou preto

Canopla compacta exclusiva para
forros de gesso



● PDH1559PT

Pendente

1xG9 HALOPIN LED 5W
Dimensões: C120 x L120 x A320 mm
Tensão: Bivolt (127V/220V)
Potência máxima: 5W
Cabo ajustável até 1500mm

● PDH1559DO

Pendente

1xG9 HALOPIN LED 5W
Dimensões: C120 x L120 x A320 mm
Tensão: Bivolt (127V/220V)
Potência máxima: 5W
Cabo ajustável até 1500mm



PDH1559PT
1 esfera de 12cm

PDH1559TRPT
1 esfera de 12cm

PDH1559CHPT
1 esfera de 12cm



PDH1559DO
1 esfera de 12cm

PDH1559TRDO
1 esfera de 12cm

PDH1559CHDO
1 esfera de 12cm



PDH1559PT

Orbit II

Estrutura: Alumínio/cúpula de vidro
Difusor: Opalino, Champagne ou Misto
(opalino interno e cristal externo)
Acabamento: Dourado fosco ou preto fosco

*A dimensão total do produto irá variar de acordo com a esfera utilizada



● ARH1536PT

Arandela

1xG9 HALOPIN LED 5W
Dimensões: C140 x L110 x A300 mm
Tensão: Bivolt (127V/220V)
Potência máxima: 5W
Cabo de 1500mm com interruptor liga e desliga para ser ligado a tomada



● ARH1536DO

Arandela

1xG9 HALOPIN LED 5W
Dimensões: C140 x L110 x A300 mm
Tensão: Bivolt (127V/220V)
Potência máxima: 5W
Cabo de 1500mm com interruptor liga e desliga para ser ligado a tomada



ARH1536PT
1 esfera de 10cm

ARH1536TRPT
*1 esfera de 12cm

ARH1536CHPT
1 esfera de 10cm



ARH1536DO
1 esfera de 10cm

ARH1536TRDO
*1 esfera de 12cm

ARH1536CHDO
1 esfera de 10cm



Canopla compacta exclusiva para forros de gesso



● **PDH1539PT**

Pendente

4xG9 HALOPIN LED 5W
 Dimensões: C900 x L100 x A230 mm
 Tensão: Bivolt (127V/220V)
 Potência máxima: 20W
 Cabo ajustável até 1500mm



PDH1539PT

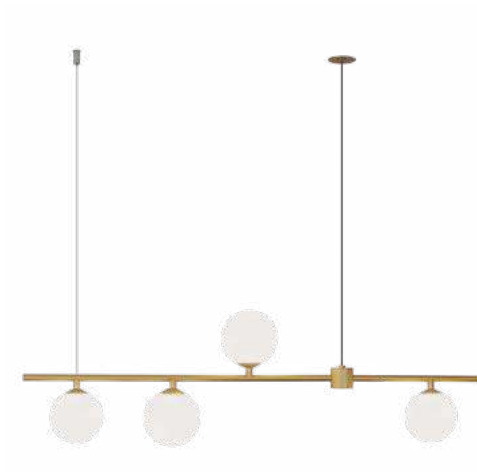

● **PDH1539DO**

Pendente

4xG9 HALOPIN LED 5W
 Dimensões: C900 x L100 x A230 mm
 Tensão: Bivolt (127V/220V)
 Potência máxima: 20W
 Cabo ajustável até 1500mm



PDH1539PT

*2 esferas de 10cm e
2 esferas de 12cm

PDH1539TRPT

2 esferas de 12cm

PDH1539CHPT

2 esferas de 10cm e
2 esferas de 12cm



PDH1539DO

*2 esferas de 10cm e
2 esferas de 12cm

PDH1539TRDO

2 esferas de 12cm

PDH1539CHDO

2 esferas de 10cm e
2 esferas de 12cm

Orbit II

Estrutura: Alumínio/cúpula de vidro
Difusor: Opalino, Champagne ou Misto
(opalino interno e cristal externo)
Acabamento: Dourado fosco ou preto fosco

Canopla compacta exclusiva para forros de gesso

***A dimensão total do produto irá variar de acordo com a esfera utilizada**



● PDH1534PT

Pendente

1xG9 HALOPIN LED 5W
Dimensões: C100 x L100 x A235 mm
Tensão: Bivolt (127V/220V)
Potência máxima: 5W
Cabo ajustável até 1500mm

● PDH1534CHDO

Pendente

1xG9 HALOPIN LED 5W
Dimensões: C100 x L100 x A235 mm
Tensão: Bivolt (127V/220V)
Potência máxima: 5W
Cabo ajustável até 1500mm



PDH1534PT
1 esfera de 10cm



PDH1534TRPT
*1 esfera de 12cm



PDH1534CHPT
1 esfera de 10cm



PDH1534DO
1 esfera de 10cm



PDH1534TRDO
*1 esfera de 12cm



PDH1534CHDO
1 esfera de 10cm

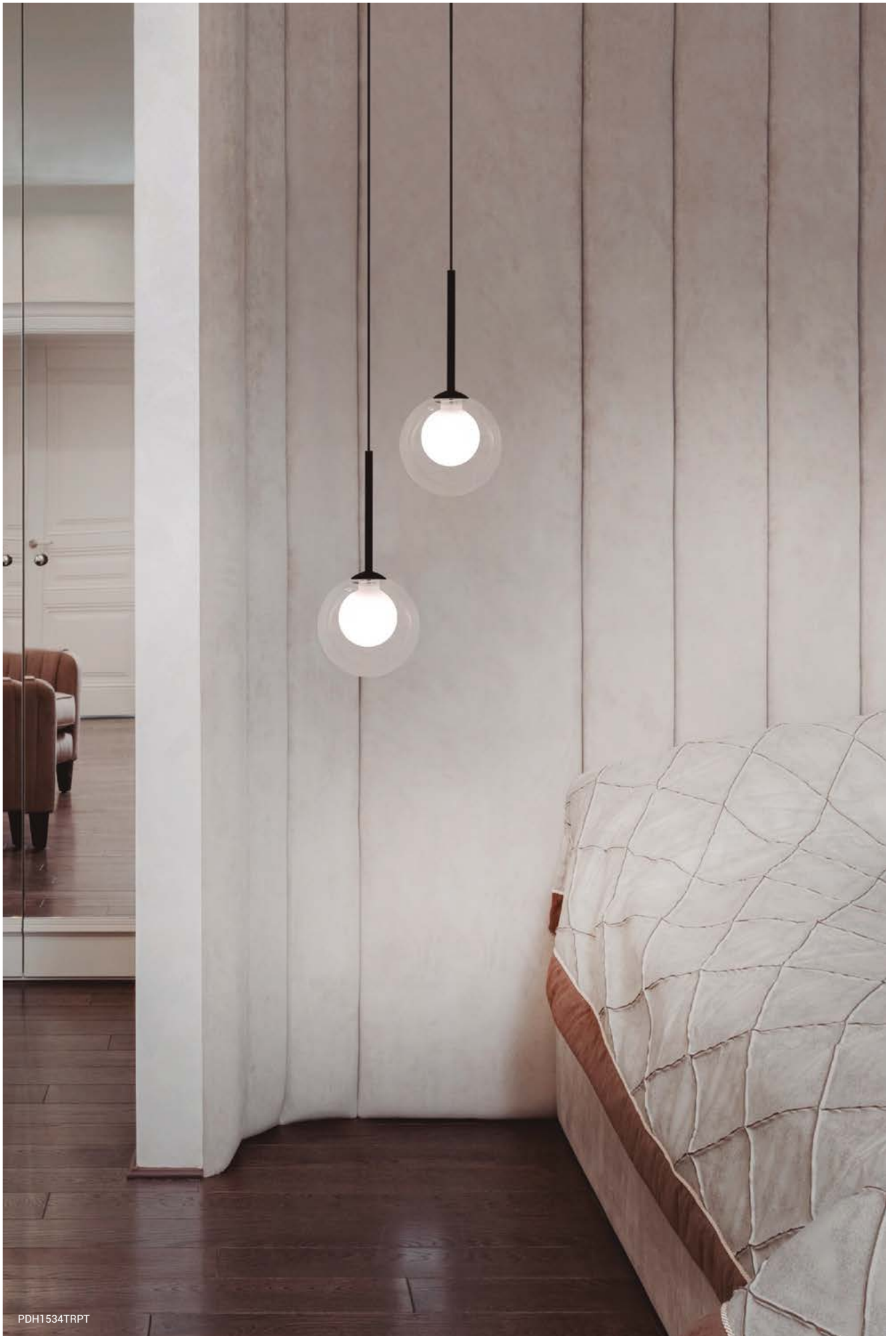

PDH1534TRPT

Sierra

Estrutura: Alumínio/cúpula de vidro

Difusor: Cúpula branca opalina

Acabamento: Preto



● AR1580PT

Arandela

1xG9 HALOPIN LED 5W

Dimensões: C200 x L100 x A250 mm

Tensão: Bivolt (127V/220V)

Potência máxima: 5W

Cabo de 1500mm com interruptor liga e desliga para ser ligado a tomada



LMH1580PT

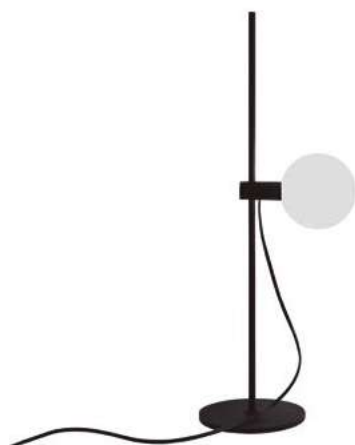

● LMH1580PT

Luminária de mesa

1xG9 HALOPIN LED 5W

Dimensões: C200 x L100 x A400 mm

Tensão: Bivolt (127V/220V)

Potência máxima: 5W

Cabo de 1500mm com interruptor liga e desliga para ser ligado a tomada



● CLH1580PT

Coluna

1xG9 HALOPIN LED 5W

Dimensões: C200 x L100 x A1200 mm

Tensão: Bivolt (127V/220V)

Potência máxima: 5W

Cabo de 1500mm com interruptor liga e desliga para ser ligado a tomada



CLH1580PT

Zaz

Estrutura: Alumínio/cúpula de vidro

Difusor: Cúpula branca opalina

Acabamento: Preto ou Dourado

Possibilidade de composições variadas

Acabamentos dourado ou preto



PLH1590PT



● PLH1590PT

Plafon/Arandela

3xG9 HALOPIN LED 5W

Dimensões: C425 x L225 x A110 mm

Tensão: Bivolt (127V/220V)

Potência máxima: 15W

3 esferas de 8cm

● PLH1901DO

Plafon/Arandela

6xG9 HALOPIN LED 5W

Dimensões: C425 x L225 x A110 mm

Tensão: Bivolt (127V/220V)

Potência máxima: 30W

6 esferas de 8cm

Possibilidade de
composições
variadas

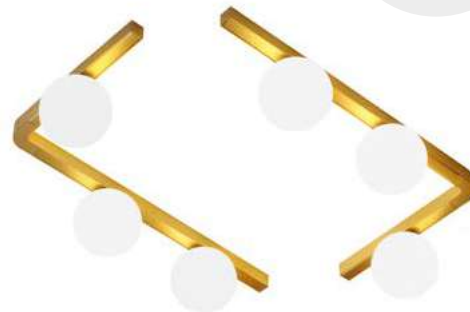

PLH1590PT
3 esferas de 8cm

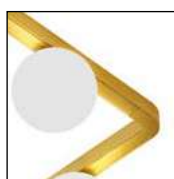

PLH1590DO
3 esferas de 8cm

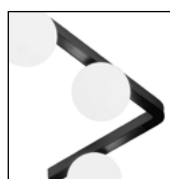

PDH1592PT
9 esferas de 8cm



PDH1592DO
9 esferas de 8cm

Possibilidade de
composições
variadas

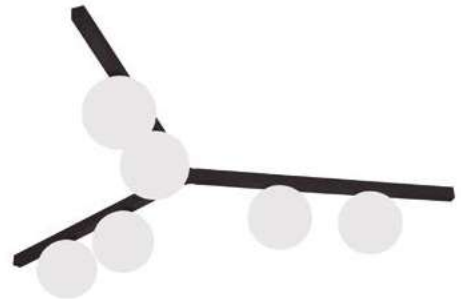

● **PLH1591PT**

Plafon

6xG9 HALOPIN LED 5W
Dimensões: C700 x L600 x A110 mm
Tensão: Bivolt (127V/220V)
Potência máxima: 30W
3 esferas de 8cm

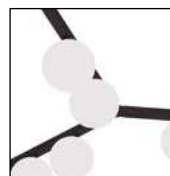

PLH1591PT
3 esferas de 8cm

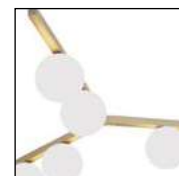

PLH1591DO
3 esferas de 8cm

Zaz

Estrutura: Alumínio/cúpula de vidro

Difusor: Cúpula branca opalina

Acabamento: Preto

Canopla compacta exclusiva para
forros de gesso

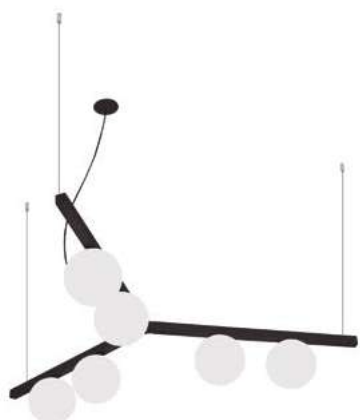

● PDH1591PT

Pendente

6xG9 HALOPIN LED 5W
Dimensões: C700 x L600 x A110 mm
Tensão: Bivolt (127V/220V)
Potência máxima: 30W
6 esferas de 8cm

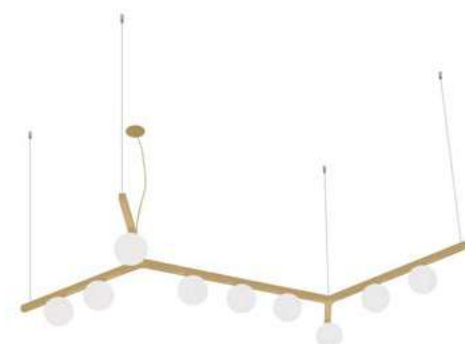

● PDH1592DO

Pendente

9xG9 HALOPIN LED 5W
Dimensões: C1100 x L800 x A110 mm
Tensão: Bivolt (127V/220V)
Potência máxima: 45W
9 esferas de 8cm



PDH1591PT
6 esferas de 8cm



PDH1591DO
6 esferas de 8cm



PDH1592PT
9 esferas de 8cm

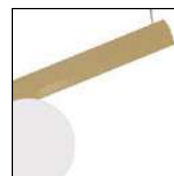

PDH1592DO
9 esferas de 8cm



Hook

Estrutura: Alumínio/cúpula de vidro
Difusor: Opalino, Champagne ou Misto
(opalino interno e cristal externo)
Acabamento: Dourado ou preto fosco

***A dimensão total do produto irá variar de acordo com a esfera utilizada**



ARH1560PT



● ARH1560PT

Arandela

1xG9 HALOPIN LED 5W
Dimensões: C130 x L100 x A180 mm
Tensão: Bivolt (127V/220V)
Potência máxima: 5W
Cabo de 1500mm com interruptor liga e desliga para ser ligado a tomada



● ARH1560DO

Arandela

1xG9 HALOPIN LED 5W
Dimensões: C130 x L100 x A180 mm
Tensão: Bivolt (127V/220V)
Potência máxima: 5W
Cabo de 1500mm com interruptor liga e desliga para ser ligado a tomada



ARH1560PT

*1 esfera de 10cm

ARH1560TRPT

1 esfera de 12cm

ARH1560CHPT

1 esfera de 10cm



ARH1560DO

*1 esfera de 10cm

ARH1560TRDO

1 esfera de 12cm

ARH1560CHDO

1 esfera de 10cm



Canopla compacta exclusiva para forros de gesso



PDH1544PT



● **PDH1544PT**
Pendente

1xG9 HALOPIN LED 5W
Dimensões: C130 x L100 x A180 mm
Tensão: Bivolt (127V/220V)
Potência máxima: 5W
Cabo ajustável até 1500mm



● **PDH1544DO**
Pendente

1xG9 HALOPIN LED 5W
Dimensões: C130 x L100 x A180 mm
Tensão: Bivolt (127V/220V)
Potência máxima: 5W
Cabo ajustável até 1500mm



PDH1544PT *1 esfera de 10cm
PDH1544TRPT 1 esfera de 12cm
PDH1544CHPT 1 esfera de 10cm



PDH1544DO *1 esfera de 10cm
PDH1544TRDO 1 esfera de 12cm
PDH1544CHDO 1 esfera de 10cm

Hook

Estrutura: Alumínio/cúpula de vidro
Difusor: Opalino, Champagne ou Misto
(opalino interno e cristal externo)
Acabamento: Dourado fosco ou preto fosco

Canopla compacta exclusiva para forros de gesso

***A dimensão total do produto irá variar de acordo com a esfera utilizada**

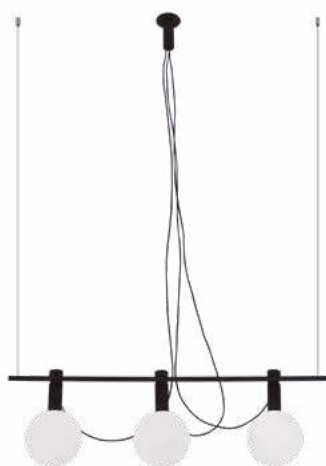

● PDH1545PT

Pendente

3xG9 HALOPIN LED 5W
Dimensões: C600 x L100 x A180 mm
Tensão: Bivolt (127V/220V)
Potência máxima: 15W
Cabo ajustável até 1500mm

● PDH1545DO

Pendente

3xG9 HALOPIN LED 5W
Dimensões: C600 x L100 x A180 mm
Tensão: Bivolt (127V/220V)
Potência máxima: 15W
Cabo ajustável até 1500mm



PDH1545PT
*3 esferas de 10cm

PDH1545TRPT
3 esferas de 12cm

PDH1545CHPT
3 esferas de 10cm



PDH1545DO
*3 esferas de 10cm

PDH1545TRDO
3 esferas de 12cm

PDH1545CHDO
3 esferas de 10cm



PDH1545TRPT

Hook

Estrutura: Alumínio/cúpula de vidro
Difusor: Opalino, Champagne ou Misto
(opalino interno e cristal externo)
Acabamento: Dourado fosco ou preto fosco

Canopla compacta exclusiva para forros de gesso

***A dimensão total do produto irá variar de acordo com a esfera utilizada**



PDH1546TRPT



● PDH1546PT

Pendente

4xG9 HALOPIN LED 5W
Dimensões: C900 x L100 x A180 mm
Tensão: Bivolt (127V/220V)
Potência máxima: 20W
Cabo ajustável até 1500mm

● PDH1546DO

Pendente

4xG9 HALOPIN LED 5W
Dimensões: C900 x L100 x A180 mm
Tensão: Bivolt (127V/220V)
Potência máxima: 20W
Cabo ajustável até 1500mm



PDH1546PT

*4 esferas de 10cm

PDH1546TRPT

4 esferas de 12cm

PDH1546CHPT

4 esferas de 10cm



PDH1546DO

*4 esferas de 10cm

PDH1546TRDO

4 esferas de 12cm

PDH1546CHDO

4 esferas de 10cm



● **PDH1547PT**

Pendente

6xG9 HALOPIN LED 5W
 Dimensões: C1200 x L100 x A180 mm
 Tensão: Bivolt (127V/220V)
 Potência máxima: 30W
 Cabo ajustável até 1500mm



PDH1547PT



● **PDH1547DO**

Pendente

6xG9 HALOPIN LED 5W
 Dimensões: C1200 x L100 x A180 mm
 Tensão: Bivolt (127V/220V)
 Potência máxima: 30W
 Cabo ajustável até 1500mm



PDH1547PT
*6 esferas de 10cm

PDH1547TRPT
6 esferas de 12cm

PDH1547CHPT
6 esferas de 10cm



PDH1547DO
*6 esferas de 10cm

PDH1547TRDO
6 esferas de 12cm

PDH1547CHDO
6 esferas de 10cm

Hook

Estrutura: Alumínio/cúpula de vidro
Difusor: Opalino, Champagne ou Misto
(opalino interno e cristal externo)
Acabamento: Dourado fosco ou preto fosco

Canopla compacta exclusiva para forros de gesso

***A dimensão total do produto irá variar de acordo com a esfera utilizada**



● PDH1549PT

Pendente

5xG9 HALOPIN LED 5W
Dimensões: C685 x L685 x A180 mm
Tensão: Bivolt (127V/220V)
Potência máxima: 25W
Cabo ajustável até 1500mm

● PDH1549DO

Pendente

5xG9 HALOPIN LED 5W
Dimensões: C685 x L685 x A180 mm
Tensão: Bivolt (127V/220V)
Potência máxima: 25W
Cabo ajustável até 1500mm



PDH1549PT
*5 esferas de 10cm



PDH1549TRPT
5 esferas de 12cm



PDH1549CHPT
5 esferas de 10cm



PDH1549DO
*5 esferas de 10cm



PDH1549TRDO
5 esferas de 12cm



PDH1549CHDO
4 esferas de 10cm



PDH1550TRDO



● **PDH1550PT**

Pendente

6xG9 HALOPIN LED 5W
 Dimensões: C885 x L885 x A180 mm
 Tensão: Bivolt (127V/220V)
 Potência máxima: 30W
 Cabo ajustável até 1500mm



● **PDH1550DO**

Pendente

6xG9 HALOPIN LED 5W
 Dimensões: C885 x L885 x A180 mm
 Tensão: Bivolt (127V/220V)
 Potência máxima: 30W
 Cabo ajustável até 1500mm



PDH1550PT
 *6 esferas de 10cm

PDH1550TRPT
 6 esferas de 12cm

PDH1550CHPT
 6 esferas de 10cm



PDH1550DO
 *6 esferas de 10cm

PDH1550TRDO
 6 esferas de 12cm

PDH1550CHDO
 6 esferas de 10cm

Hook

Estrutura: Alumínio/cúpula de vidro
Difusor: Opalino, Champagne ou Misto
(opalino interno e cristal externo)
Acabamento: Dourado fosco ou preto fosco

Canopla compacta exclusiva para forros de gesso

***A dimensão total do produto irá variar de acordo com a esfera utilizada**



● PDH1551PT

Pendente

8xG9 HALOPIN LED 5W
Dimensões: C885 x L885 x A180 mm
Tensão: Bivolt (127V/220V)
Potência máxima: 40W
Cabo ajustável até 1500mm

● PDH1551DO

Pendente

8xG9 HALOPIN LED 5W
Dimensões: C885 x L885 x A180 mm
Tensão: Bivolt (127V/220V)
Potência máxima: 40W
Cabo ajustável até 1500mm



PDH1551PT

*8 esferas de 10cm



PDH1551TRPT

8 esferas de 12cm



PDH1551CHPT

8 esferas de 10cm



PDH1551DO

*8 esferas de 10cm



PDH1551TRDO

8 esferas de 12cm



PDH1551CHDO

8 esferas de 10cm



PDH1551PT

Cadre

Estrutura: Metal/cúpula de vidro

Difusor: Cúpula champagne ou

Cúpula branca

Acabamento: Bronze ou Preto

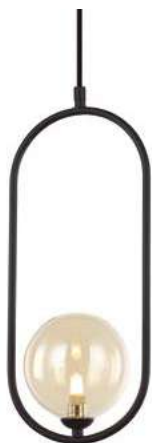

● PD1333PT

Pendente

1xG9 HALOPIN LED 5W

Dimensões: C170 x L120 x A405 mm

Tensão: Bivolt (127V/220V)

Potência máxima: 5W

Cabo ajustável até 1500mm

● PD1333BZ-BR

Pendente

1xG9 HALOPIN LED 5W

Dimensões: C170 x L120 x A405 mm

Tensão: Bivolt (127V/220V)

Potência máxima: 5W

Cabo ajustável até 1500mm



PD1333PT

Cúpula champagne

PD1333BZ

Cúpula champagne

R\$ 192,54

R\$ 216,60



PD1333PT-BR

Cúpula branca

PD1333BZ-BR

Cúpula branca

R\$ 192,54

R\$ 216,60



● **PD1334PT**

Pendente

2xG9 HALOPIN LED 5W
Dimensões: C170 x L120 x A485 mm
Tensão: Bivolt (127V/220V)
Potência máxima: 10W
Cabo ajustável até 1500mm



● **PD1334BZ-BR**

Pendente

2xG9 HALOPIN LED 5W
Dimensões: C170 x L120 x A485 mm
Tensão: Bivolt (127V/220V)
Potência máxima: 10W
Cabo ajustável até 1500mm



PD1334PT

Cúpula champagne

PD1334BZ

Cúpula champagne

R\$ 297,97

R\$ 341,63



PD1334PT-BR

Cúpula branca

PD1334BZ-BR

Cúpula branca

R\$ 297,97

R\$ 341,63

Cadre

Estrutura: Metal/cúpula de vidro

Difusor: Cúpula champagne ou

Cúpula branca

Acabamento: Bronze



PD1333BZ-BR

● PD1329BZ

Pendente

4xG9 HALOPIN LED 5W

Dimensões: C950 x L120 x A480 mm

Tensão: Bivolt (127V/220V)

Potência máxima: 20W

Cabo ajustável até 1500mm



PD1329BZ
Cúpula champagne



PD1329BZ-BR
Cúpula branca

Cadre

Estrutura: Metal/cúpula de vidro

Difusor: Cúpula champagne ou

Cúpula branca

Acabamento: Bronze ou Preto



● AR1332PT

Arandela

1xG9 HALOPIN LED 5W

Dimensões: C200 x L120 x A390 mm

Tensão: Bivolt (127V/220V)

Potência máxima: 5W



● AR1332BZ-BR

Arandela

1xG9 HALOPIN LED 5W

Dimensões: C200 x L120 x A390 mm

Tensão: Bivolt (127V/220V)

Potência máxima: 5W



AR1332PT

Cúpula champagne

AR1332BZ

Cúpula champagne

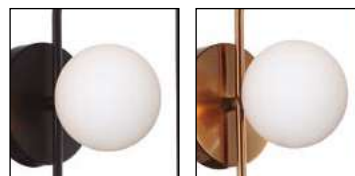

AR1332PT-BR

Cúpula champagne

AR1332BZ-BR

Cúpula branca

Cadre

Estrutura: Metal/cúpula de vidro

Difusor: Cúpula champagne ou
Cúpula branca

Acabamento: Bronze



● **AB1378BZ**

Abajur

1xG9 HALOPIN LED 5W

Dimensões: C170 x L120 x A420 mm

Tensão: Bivolt (127V/220V)

Potência máxima: 5W

Cabo de 1500mm com interruptor liga e desliga para ser ligado a tomada



AB1378BZ
Cúpula champagne



AB1378BZ-BR
Cúpula branca



AB1378BZ-BR

Mini Moon

Estrutura: Metal/cúpula de acrílico

Difusor: Branco

Acabamento: Dourado ou Preto



● PD1638PT

Pendente

1xG9 HALOPIN LED 7W
Dimensões: \varnothing 120 x A250 mm
Tensão: Bivolt (127V/220V)
Potência máxima: 7W
Cabo ajustável até 2000mm



PD1638DO

Acabamento
dourado



PD1638PT

Acabamento preto



PD1638DO

Sears

Estrutura: Metal/cúpula de vidro
Difusor: Cúpula branca opalina
Acabamento: Dourado ou Preto



● PD1629DO

Pendente

5xG9 5W / 5 xGU10 50W
Dimensões: C1120 x L260 x A1150 mm
Tensão: Bivolt (127V/220V)
Potência máxima: 275W
Cabo ajustável até 1500mm



● PD1611DO

Pendente

1xG9 5W / 1 xGU10 50W
Dimensões: C200 x L120 x A1555 mm
Tensão: Bivolt (127V/220V)
Potência máxima: 55W

Novo Acabamento



AR1628BR
Acabamento branco



AR1628DO
Acabamento dourado



AR1628PT
Acabamento preto



PD1611DO
Acabamento dourado



PD1611PT
Acabamento preto



● **AR1628DO**

Arandela

1xG9 5W / 1 xGU10 50W
Dimensões: C235 x A200 mm
Tensão: Bivolt (127V/220V)
Potência máxima: 55W

Novo Acabamento



AR1628BR
Acabamento branco



AR1628DO
Acabamento dourado



AR1628PT
Acabamento preto



AR1628DO

Sears

Estrutura: Metal/cúpula de vidro

Difusor: Cúpula branca opalina

Acabamento: Dourado ou Preto



● CL1630PT

Coluna

1xG9 5W / 1 xGU10 50W

Dimensões: C300 x L250 x A1163 mm

Tensão: Bivolt (127V/220V)

Potência máxima: 55W

Cabo de 1500mm com interruptor liga e desliga para ser ligado a tomada



● AB1631PT

Abajur

1xG9 5W / 1 xGU10 50W

Dimensões: C230 x L100 x A430 mm

Tensão: Bivolt (127V/220V)

Potência máxima: 55W

Cabo de 1500mm com interruptor liga e desliga para ser ligado a tomada

Novo Acabamento



CL1630BR

Acabamento branco



CL1630DO

Acabamento dourado



CL1630PT

Acabamento preto

Novo Acabamento



AB1631BR

Acabamento branco



AB1631DO

Acabamento dourado



AB1631PT

Acabamento preto



AB1631DO

Trento

Estrutura: Metal/cúpula de vidro
Difusor: Cúpula Branca / Fumê
ou Champagne
Acabamento: Dourado ou Preto



PDH1583BRPT



● PDH1583BRPT

Pendente

1xG9 5W
Dimensões: Ø130 x A150 mm
Tensão: Bivolt (127V/220V)
Potência máxima: 5W
Cabo ajustável até 1500mm

● PDH1583BRDO

Pendente

1xG9 5W
Dimensões: Ø130 x A150 mm
Tensão: Bivolt (127V/220V)
Potência máxima: 5W
Cabo ajustável até 1500mm



PDH1583BRPT

1 esfera de 8cm
branco opalino



PDH1583FMPT

1 esfera de 8cm
branco opalino



PDH1583BRDO

1 esfera de 8cm
branco opalino



PDH1583ABDO

1 esfera de 8cm
branco opalino



● **ARH1583BRPT**

Arandela

1xG9 5W

Dimensões: C200 x L130 x A250 mm

Tensão: Bivolt (127V/220V)

Potência máxima: 5W



● **ARH1583ABDO**

Arandela

1xG9 5W

Dimensões: C200 x L130 x A250 mm

Tensão: Bivolt (127V/220V)

Potência máxima: 5W

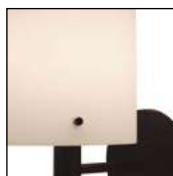

ARH1583BRPT

1 esfera de 8cm
branco opalino

ARH1583FMPT

1 esfera de 8cm
branco opalino



ARH1583BRDO

1 esfera de 8cm
branco opalino

ARH1583ABDO

1 esfera de 8cm
branco opalino

Trento

Estrutura: Metal/cúpula de vidro

Difusor: Cúpula Branca / Fumê
ou Champagne

Acabamento: Dourado ou Preto



● ABH1584FMPT

Pendente

1xG9 5W

Dimensões: Ø130 x A400 mm

Tensão: Bivolt (127V/220V)

Potência máxima: 5W

Possui cabo de 1200mm com interruptor
liga e desliga para ser ligado a tomada



● ABH1584BRDO

Pendente

1xG9 5W

Dimensões: Ø130 x A400 mm

Tensão: Bivolt (127V/220V)

Potência máxima: 5W

Possui cabo de 1200mm com interruptor
liga e desliga para ser ligado a tomada



ABH1584BRPT

1 esfera de 8cm
branco opalino



ABH1584FMPT

1 esfera de 8cm
branco opalino



ABH1584BRDO

1 esfera de 8cm
branco opalino



ABH1584ABDO

1 esfera de 8cm
branco opalino



ABH1584ABDO

Deuce

Estrutura: Metal/cúpula de vidro
Difusor: Cúpula Branca ou Champagne
Acabamento: Dourado bronze



● **AR1346**

Arandela

2xG9 5W
Dimensões: C170 x L220 x A500 mm
Tensão: Bivolt (127V/220V)
Potência máxima: 10W

● **PD1347**

Pendente

2xG9 5W
Dimensões: C170 x L120 x A495 mm
Tensão: Bivolt (127V/220V)
Potência máxima: 10W
Cabo ajustável até 1500mm



AR1346
2 cúpulas
champagne

AR1346BR
2 cúpulas branca
opalina



PD1347
2 cúpulas
champagne

PD1347BR
2 cúpulas branca
opalina



PD1347

Neolus

Estrutura: Metal/cúpula de vidro

Difusor: Cúpula Branca

Acabamento: Dourado



● AR1459

Arandela

2xG9 (LED) 5W

Dimensões: C230 x L130 x A350 mm

Tensão: Bivolt (127V/220V)

Potência máxima: 10W



● PD1460

Pendente

6xG9 5W

Dimensões: Ø760 x A515 mm

Tensão: Bivolt (127V/220V)

Potência máxima: 30W

Haste ajustável até 620mm



● PD1461

Pendente

9xG9 5W

Dimensões: Ø920 x A515 mm

Tensão: Bivolt (127V/220V)

Potência máxima: 45W

Haste ajustável até 620mm



PD1461

Hunt

Estrutura: Metal/cúpula de vidro
Difusor: Cúpula transparente/cúpula interna fosca
Acabamento: Preto (Detalhes em cobre)



● AR1264

Arandela

2xG9 (LED) 5W
Dimensões: C120 x L270 x A370 mm
Tensão: Bivolt (127V/220V)
Potência máxima: 10W



● PD1262

Pendente

8xG9 5W
Dimensões: Ø590 x A500 mm
Tensão: Bivolt (127V/220V)
Potência máxima: 40W
Haste ajustável até 760mm



PD1262

DNA

Estrutura: Metal/cúpula de vidro
Difusor: Cúpula transparente (interno fosco)
Acabamento: Cobre



PD1298

● AR1381

Arandela

2xG9 (LED) 5W
Dimensões: C100 x L125 x A240 mm
Tensão: Bivolt (127V/220V)
Potência máxima: 10W



● PD1298

Pendente

12xG9 5W
Dimensões: C680 x L270 x A330 mm
Tensão: Bivolt (127V/220V)
Potência máxima: 60W
Cabo ajustável até 1500mm

● PD1298G

Pendente

16xG9 5W
Dimensões: C800 x L250 x A400 mm
Tensão: Bivolt (127V/220V)
Potência máxima: 80W
Cabo ajustável até 1500mm

Atomy

Estrutura: Metal/cúpula de vidro

Difusor: Cúpula craquelê /
cúpula branca

Acabamento: Cobre



● **PD1269**
Pendente

12xG9 (LED) 5W
Dimensões: Ø775 x A370 mm
Tensão: Bivolt (127V/220V)
Potência máxima: 60W
Cabo ajustável até 1500mm



● **PD1268**
Pendente

7xG9 5W
Dimensões: Ø545 x A490 mm
Tensão: Bivolt (127V/220V)
Potência máxima: 35W
Cabo ajustável até 1500mm



● **AR1261**
Arandela

1xG9 5W
Dimensões: C140 x L120 x A180 mm
Tensão: Bivolt (127V/220V)
Potência máxima: 5W



PD1298
7 cúpulas craquelê



PD1298BR
1 cúpula branca opalina



PD1269
12 cúpulas craquelê



PD1269BR
1 cúpula branca opalina



AR1261
1 cúpula craquelê



AR1261BR
1 cúpula branca opalina



PD1269BR

Biene

Estrutura: Metal/cúpula de vidro

Difusor: Cúpula Branca

Acabamento: Preto com dourado /

Preto com Cobre / Nude com dourado

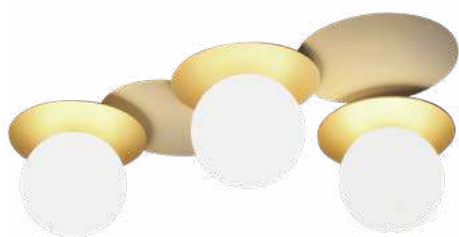

● PL1486NFDO

Plafon

3xG9 (LED) 5W

Dimensões: C460 x L270 x A147 mm

Tensão: Bivolt (127V/220V)

Potência máxima: 15W



● PL1405CO

Plafon

6xG9 5W

Dimensões: C610 x L490 x A147 mm

Tensão: Bivolt (127V/220V)

Potência máxima: 30W



PL1486CO
Detalhe dourado

Novo Acabamento

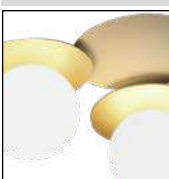

PL1486NFDO
Detalhe nude fosco



PL1405CO
Detalhe cobre

Novo Acabamento



PL1405NFDO
Detalhe nude fosco



Link

Estrutura: Metal/cúpula de vidro

Difusor: Cúpula champagne /
cúpula branca

Acabamento: Bronze



● PD987

Pendente

12xG9 (LED) 5W
Dimensões: Ø730 x A330 mm
Tensão: Bivolt (127V/220V)
Potência máxima: 60W
Cabo ajustável de 1500mm



● PD987BR

Pendente

12xG9 (LED) 5W
Dimensões: Ø730 x A330 mm
Tensão: Bivolt (127V/220V)
Potência máxima: 60W
Cabo ajustável de 1500mm



PD987BR



Cosmos

Estrutura: Metal/cúpula de vidro

Difusor: Cúpula champagne /

Cúpula branca

Acabamento: Bronze / Preto



● PD1430BR

Pendente

8xG9 5W

Dimensões: C900 x L670 x A450 mm

Tensão: Bivolt (127V/220V)

Potência máxima: 40W

Cabo ajuste até 1500mm



● PD1430PTBR

Pendente

8xG9 5W

Dimensões: C900 x L670 x A450 mm

Tensão: Bivolt (127V/220V)

Potência máxima: 40W

Cabo ajuste até 1500mm

LANÇAMENTO 2022



PD1430CH

8 esfera champagne



PD1430BR

8 esfera branco opalino

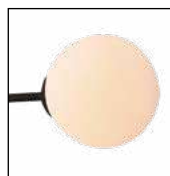

PD1430PTBR

8 esfera champagne

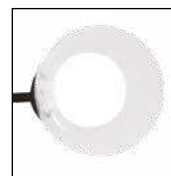

PD1430PTTR

8 esfera branco opalino



PD1430PTCH

8 esfera branco opalino



● **PD1431CH**

Pendente

6xG9 5W

Dimensões: C1100 x L380 x A380 mm

Tensão: Bivolt (127V/220V)

Potência máxima: 30W

Cabo ajuste até 1500mm



PD1431CH
6 esfera champagne



PD1431BR
6 esfera branco
opalino

Belle

Estrutura: Metal/cúpula de vidro

Difusor: Vidro craquelê

Acabamento: Dourado



AR1635

Arandela

LED: 3,5W

Lúmens: 210lm

Temperatura: 3000K

Dimensões: C110 x L120 x A260 mm

Tensão: Bivolt (127V/220V)

Potência máxima: 3,5W



PD1636



PD1634

Pendente

LED: 7W

Lúmens: 420lm

Temperatura: 3000K

Dimensões: C150 x L120 x A332 mm

Tensão: Bivolt (127V/220V)

Potência máxima: 7W

Cabo ajustável até 1500mm

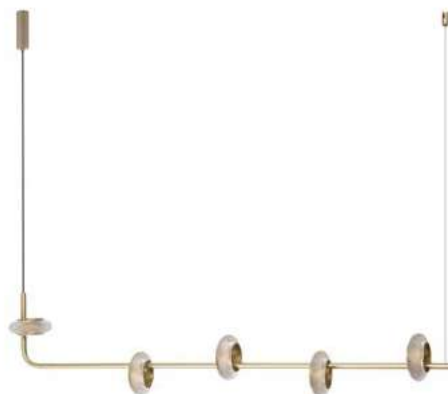

PD1636

Pendente

LED: 17,5W

Lúmens: 1050lm

Temperatura: 3000K

Dimensões: C1150 x L11 x A2700 mm

Tensão: Bivolt (127V/220V)

Potência máxima: 17,5W

Cabo ajustável até 1500mm

Ravelo

Estrutura: Metal/cúpula de vidro

Difusor: Cúpula fumê ou Cúpula champagne

Acabamento: Preto ou Dourado



● PDH1581CH

Pendente

1xE27 40W

Dimensões: Ø150 x A300 mm

Tensão: Bivolt (127V/220V)

Potência máxima: 40W

Cabo ajustável até 1500mm



● PDH1582CH

Pendente

5xE27 40W

Dimensões: Ø150 x A300 mm

Tensão: Bivolt (127V/220V)

Potência máxima: 200W

Cabo ajustável até 1500mm



PDH1581FM

1 esfera fumê



PDH1581CH

1 esfera champagne



PDH1582FM

5 esfera fumê



PDH1582CH

5 esfera champagne

Torchia

Estrutura: Metal/cúpula de vidro

Difusor: Cúpula champagne

Acabamento: Dourada



● AR1462

Arandela

1xE27 40W

Dimensões: C353 x L150 x A203 mm

Tensão: Bivolt (127V/220V)

Potência máxima: 40W



● PD1464

Pendente

5xE27 40W

Dimensões: C1140 x L580 x A750 mm

Tensão: Bivolt (127V/220V)

Potência máxima: 200W

Haste ajustável até
700mm(400mm+300mm)



● PD1465

Pendente

7xE27 40W

Dimensões: C1300 x L700 x A750 mm

Tensão: Bivolt (127V/220V)

Potência máxima: 280W

Haste ajustável até
700mm(400mm+300mm)



PD1465

Cutie

Estrutura: Metal/cúpula de vidro

Difusor: Cúpula champagne ou

Cúpula fumê

Acabamento: Cobre ou Preto



● PD1330FM

Pendente

4xE27 40W

Dimensões: C910 x L150 x A360 mm

Tensão: Bivolt (127V/220V)

Potência máxima: 160W

Cabo ajustável até 1500mm



● PD1331CH

Pendente

6xE27 40W

Dimensões: 720 x A605 mm

Tensão: Bivolt (127V/220V)

Potência máxima: 240W

Cabo ajustável até 1500mm



PD1330CH

4 cúpulas
champagne



PD1330FM

4 cúpulas
fumê



PD1331CH

6 cúpulas
champagne



PD1331FM

6 cúpulas
fumê



PD1330FM

Jetty

Estrutura: Metal/cúpula de vidro
Difusor: Cúpula Cobre, Cúpula fumê
ou Cúpula champagne
Acabamento: Preto / Dourado



● **PD1429CH**
Pendente

1xE27 40W
Dimensões: Ø150 xA210 mm
Tensão: Bivolt (127V/220V)
Potência máxima: 40W
Cabo ajustável até 1500mm

Novo Acabamento



PD1429CO
Cúpula cobre



PD1429FM
Cúpula fumê



PD1429CH
Cúpula champagne

Cálico

Estrutura: Metal/cúpula de vidro

Difusor: Cúpula cromada ou

Cúpula cobre

Acabamento: Preto



PD1290-CR



● PD1290-CR

Pendente

1xE27 40W

Dimensões: Ø250 xA250 mm

Tensão: Bivolt (127V/220V)

Potência máxima: 40W

Cabo ajustável até 1500mm

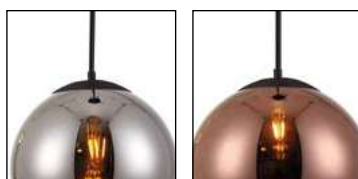

PD1290-CR

1 cúpula cromada

PD1290-CO

1 cúpula cobre



● PD1291-CO

Pendente

1xE27 40W

Dimensões: Ø350 xA350 mm

Tensão: Bivolt (127V/220V)

Potência máxima: 40W

Cabo ajustável até 1500mm

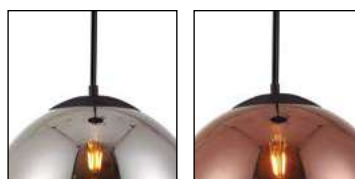

PD1291-CR

1 cúpula cromada

PD1291-CO

1 cúpula cobre

Sion

Estrutura: Metal/cúpula de vidro

Vidro: Transparente

Acabamento: Preto ou Dourado

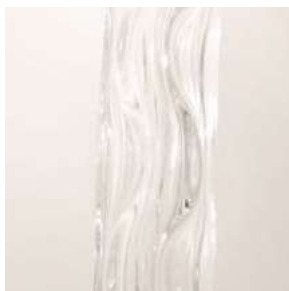

Detalhe do vidro



PDH1586PT



● ARH1585DO

Arandela

1xG9 5W

Dimensões: C120 x L45 x A120 mm

Tensão: Bivolt (127V/220V)

Potência máxima: 5W



ARH1585DO



ARH1585PT



● PDH1586PT

Pendente

1xG9 5W

Dimensões: Ø45 x A400 mm

Tensão: Bivolt (127V/220V)

Potência máxima: 5W

Cabo ajustável até 1500mm



PDH1586DO



PDH1586PT

Hilton

Estrutura: Metal/cúpula de vidro

Difusor: Cúpula transparente

Acabamento: Preto ou Dourado



PD1432PT



● PD1432DO

Pendente

1xGU10 28W

Dimensões: Ø70 x A430 mm

Tensão: Bivolt (127V/220V)

Potência máxima: 28W

Cabo ajustável até 2000mm



● AR1719PT

Arandela

1xGU10 5W

Dimensões: L70 x P120 x A1700 mm

Tensão: Bivolt (127V/220V)

Potência máxima: 5W

LANÇAMENTO 2022



PD1432DO



PD1432PT



AR1719DO



AR1719PT

Triplet

Estrutura: Metal/cúpula de vidro

Difusor: Vidro champagne

Acabamento: Bronze



● PD1081

Pendente

LED: 5W

Lúmens: 360lm

Temperatura: 3000K

Dimensões: Ø310 xA150 mm

Tensão: Bivolt (127V/220V)

Potência máxima: 5W

Cabo ajustável até 1500mm



● PD1082

Pendente

LED: 5W

Lúmens: 360lm

Temperatura: 3000K

Dimensões: Ø300 xA295 mm

Tensão: Bivolt (127V/220V)

Potência máxima: 5W

Cabo ajustável até 1500mm



● PD1083

Pendente

LED: 5W

Lúmens: 360lm

Temperatura: 3000K

Dimensões: Ø170 xA295 mm

Tensão: Bivolt (127V/220V)

Potência máxima: 5W

Cabo ajustável até 1500mm





PD1081 / PD1082 / PD1083

Bead

Estrutura: Metal/cúpula de vidro

Difusor: Cúpula champagne ou

Cúpula fumê

Acabamento: Preto ou Dourado



● QAB1323FM

Abajur

1xE27 40W (lâmpada LED de filamento)

Dimensões: Ø140 x A215 mm

Tensão: Bivolt (127V/220V)

Potência máxima: 40W

Possui cabo de 1500mm com interruptor liga e desliga para ser ligado a tomada



● QPD1324CH

Pendente

1xE27 40W (lâmpada LED de filamento)

Dimensões: Ø140 x A215 mm

Tensão: Bivolt (127V/220V)

Potência máxima: 40W

Cabo ajustável até 1500mm



QAB1323FM



QAB1323CH



QPD1324FM



QPD1324CH



QPD1324FM

Flint

Estrutura: Metal/cúpula de vidro

Difusor: Cúpula champagne /

Cúpula fumê

Acabamento: Preto ou Dourado



QAB1335CH



● QAB1335FM

Abajur

1xE27 40W (lâmpada LED de filamento)

Dimensões: Ø160 xA285 mm

Tensão: Bivolt (127V/220V)

Potência máxima: 40W

Possui cabo de 1500mm com interruptor liga e desliga para ser ligado a tomada



● QAB1335CH

Abajur

1xE27 40W (lâmpada LED de filamento)

Dimensões: Ø160 xA285 mm

Tensão: Bivolt (127V/220V)

Potência máxima: 40W

Possui cabo de 1500mm com interruptor liga e desliga para ser ligado a tomada

Spire

Estrutura: Metal/cúpula de vidro

Difusor: Cúpula champagne /

Cúpula fumê

Acabamento: Preto ou Dourado



● QAB1325CH

Abajur

1xE27 40W (lâmpada LED de filamento)

Dimensões: Ø90 xA300 mm

Tensão: Bivolt (127V/220V)

Potência máxima: 40W

Possui cabo de 1500mm com interruptor liga e desliga para ser ligado a tomada



QAB1325CH



QAB1325FM



● QPD1348FM

Pendente

1xE27 40W (lâmpada LED de filamento)

Dimensões: Ø90 xA300 mm

Tensão: Bivolt (127V/220V)

Potência máxima: 40W

Cabo ajustável até 1500mm



QPD1348CH



QPD1348FM

Pellet

Estrutura: Metal/cúpula de vidro

Difusor: Cúpula branca

Acabamento: Dourado ou Preto

NOVO
ACABAMENTO
PRETO



● **PD1236**
Pendente

1xG9 5W
Dimensões: Ø120 xA105 mm
Tensão: Bivolt (127V/220V)
Potência máxima: 5W
Cabo ajustável até 1500mm



● **PD1235**
Pendente

1xG9 5W
Dimensões: Ø120 xA130 mm
Tensão: Bivolt (127V/220V)
Potência máxima: 5W
Cabo ajustável até 1500mm



● **PD1237**
Pendente

1xG9 5W
Dimensões: Ø150 xA95 mm
Tensão: Bivolt (127V/220V)
Potência máxima: 5W
Cabo ajustável até 1500mm



PD1235
Acabamento
dourado



PD1235PT
Acabamento preto



PD1236
Acabamento
dourado



PD1236PT
Acabamento preto



PD1237
Acabamento
dourado



PD1237PT
Acabamento preto

Classic

Estrutura: Metal/cúpula de vidro

Difusor: Cúpula transparente

Acabamento: Cor madeira



● **606**
Pendente

1xE27 40W
Dimensões: Ø200 xA240 mm
Tensão: Bivolt (127V/220V)
Potência máxima: 40W
Cabo ajustável até 1500mm

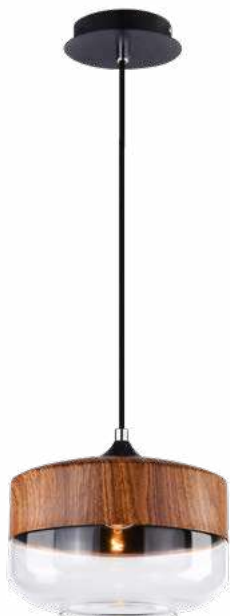

● **609**
Pendente

1xE27 40W
Dimensões: Ø250 xA250 mm
Tensão: Bivolt (127V/220V)
Potência máxima: 40W
Cabo ajustável até 1500mm



● **617**
Pendente

1xE27 40W
Dimensões: Ø130 xA320 mm
Tensão: Bivolt (127V/220V)
Potência máxima: 40W
Cabo ajustável até 1500mm

Drip

Estrutura: Metal/cúpula de vidro

Difusor: Cúpula champagne

Acabamento: Dourado



● **AR1382CH**

Arandela

1xG9 5W

Dimensões: Ø120 xA230 mm

Tensão: Bivolt (127V/220V)

Potência máxima: 5W



● **PD1077-CH**

Pendente

1xG9 5W

Dimensões: Ø120 xA230 mm

Tensão: Bivolt (127V/220V)

Potência máxima: 5W

Cabo ajustável até 1500mm

Clam

Estrutura: Metal/cúpula de vidro

Difusor: Vidro transparente ou
Vidro champagne

Acabamento: Cromado ou Champagne



PD622



● **PD622**
Pendente

1xGU10 50W
Dimensões: Ø120 x A600 mm
Tensão: Bivolt (127V/220V)
Potência máxima: 50W
Cabo ajustável até 1500mm



PD622

Vidro transparente

PD622-DO

Vidro champagne



● **AR1380DO**
Arandela

1xGU10 50W
Dimensões: Ø120 x A450 mm
Tensão: Bivolt (127V/220V)
Potência máxima: 50W



AR1380DO

Vidro champagne

AR1380CR

Vidro transparente

Tear

Estrutura: Metal/cúpula de vidro com cristais

Difusor: Cúpula transparente com cristais transparentes

Acabamento: Cobre



● **AR1433**
Arandela

1 xG9 (LED) 5W

Dimensões: C120 xL130 x A300 mm

Tensão: Bivolt (127V/220V)

Potência máxima: 5W



● **PD1434**
Pendente

1 xG9 (LED) 5W

Dimensões: Ø90 xA 225 mm

Tensão: Bivolt (127V/220V)

Potência máxima: 5W

Cabo ajustável até 1500mm



PD1434

Spring

Estrutura: Metal / cristais

Difusor: Cristais transparentes ou

Cristais ambar

Acabamento: Cobre ou Dourada

LED light



LT638



● LT637

Lustre

1 xG9 5W

Dimensões: Ø880 x A600 mm

Tensão: Bivolt (127V/220V)

Potência máxima: 5W

Cabo ajustável até 1500mm

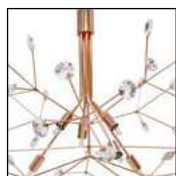

LT637

Vidro transparente



LT637-DO

Vidro ambar



● LT638-DO

Lustre

1 xG9 5W

Dimensões: Ø530 x A530 mm

Tensão: Bivolt (127V/220V)

Potência máxima: 5W

Cabo ajustável até 1500mm



LT638

Vidro transparente

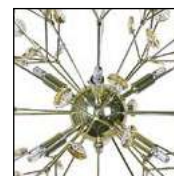

LT638-DO

Vidro ambar

Dublin

Estrutura: Metal/cúpula de vidro e pingentes de cristal

Difusor: Cúpula cromada ou

Cúpula cobre

Acabamento: Cromada ou Cobre



● QPD1279-CR

Pendente

1 xG9 40W

Dimensões: Ø130 x A150 mm

Tensão: Bivolt (127V/220V)

Potência máxima: 40W

Cabo ajustável até 1500mm



● QAR1281-CO

Arandela

1 xG9 40W

Dimensões: Ø130 x C190 x A160 mm

Tensão: Bivolt (127V/220V)

Potência máxima: 40W



QPD1279-CO
Cúpula cobre



QPD1279-CR
Cúpula cromada



QAR1281-CO
Cúpula cobre



QAR1281-CR
Cúpula cromada



QPD1279-CR

Rafik

Estrutura: Alumínio/Difusor de sílica gel

Difusor: Difusor branco

Acabamento: Branco, Preto ou Dourado

Canopla para instalação em forros de gesso e lajes

LED light



PD1618PT



● PD1618PT

Pendente

LED: 45W

Lúmens: 3600lm

Temperatura: 3000K

Dimensões: C1250 x L80 x A400 mm

Tensão: Bivolt (127V/220V)

Potência máxima: 45W

Cabo ajustável até 1500mm

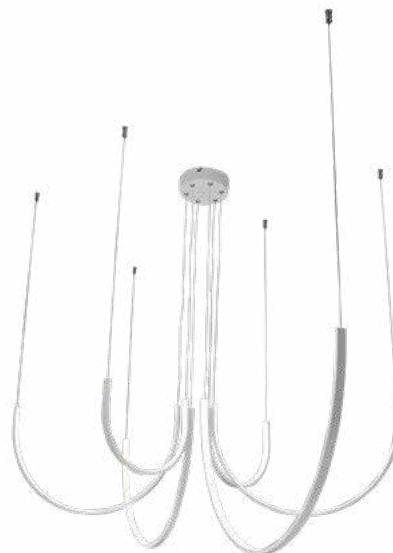

● PD16182BR

Pendente

LED: 90W

Lúmens: 7200lm

Temperatura: 3000K

Dimensões: Ø1290 mm

Tensão: Bivolt (127V/220V)

Potência máxima: 90W

Cabo ajustável até 1500mm

LANÇAMENTO 2022

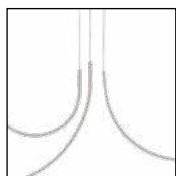

PD1618BR

Acabamento branco

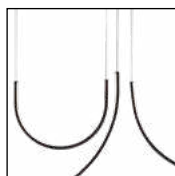

PD1618PT

Acabamento preto

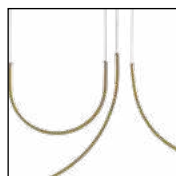

PD1618DO

Acabamento dourado

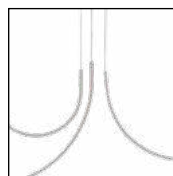

PD16182BR

Acabamento branco

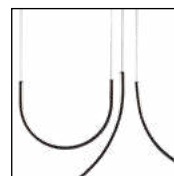

PD16182PT

Acabamento preto

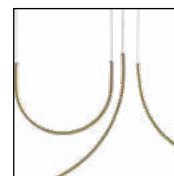

PD16182DO

Acabamento dourado

Rafik

LED light

Estrutura: Alumínio/Difusor de sílica gel

Difusor: Difusor branco

Acabamento: Branco, Preto ou Dourado

Canopla compacta exclusiva para forros de gesso



● PL1619PT

Plafon

LED: 10W

Lúmens: 800lm

Temperatura: 3000K

Dimensões: C300 x L18 x A200 mm

Tensão: Bivolt (127V/220V)

Potência máxima: 10W



● PL1620PT

Plafon

LED: 15W

Lúmens: 1200lm

Temperatura: 3000K

Dimensões: C500 x L80 x A300 mm

Tensão: Bivolt (127V/220V)

Potência máxima: 15W



PL1619BR

Acabamento branco

PL1619PT

Acabamento preto

PL1619DO

Acabamento dourado



PL1620BR

Acabamento branco

PL1620PT

Acabamento preto

PL1620DO

Acabamento dourado

Rafik

Estrutura: Alumínio/Difusor de sílica gel

Difusor: Difusor branco

Acabamento: Branco, Preto ou Dourado

Canopla compacta exclusiva para forros de gesso



PD1619PT / PD1621PT

LED light

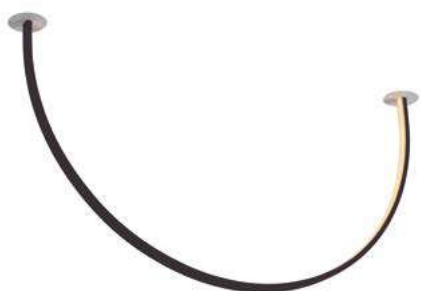

● PD1621PT

Plafon

LED: 20W

Lúmens: 1600lm

Temperatura: 3000K

Dimensões: C700 x L18 x A400 mm

Tensão: Bivolt (127V/220V)

Potência máxima: 10W



PD1621BR

Acabamento branco



PD1621PT

Acabamento preto



PD1621DO

Acabamento dourado

Sugestões de composição

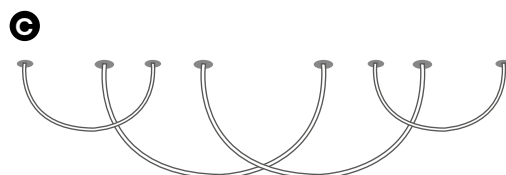
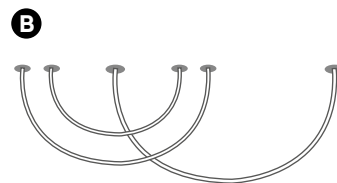
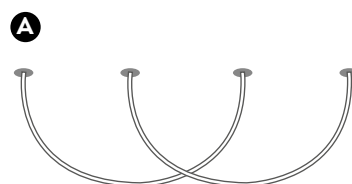

Rafik

LED light

Estrutura: Alumínio/Difusor de sílica gel

Difusor: Difusor branco

Acabamento: Branco, Preto ou Dourado

Canopla compacta exclusiva para forros de gesso



● PL1622BR

Plafon

LED: 8W

Lúmens: 640lm

Temperatura: 3000K

Dimensões: Ø200 x A20 mm

Tensão: Bivolt (127V/220V)

Potência máxima: 8W

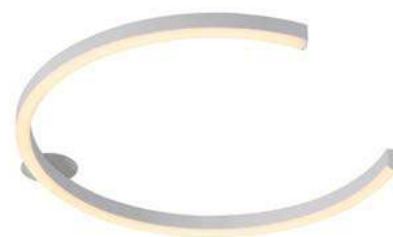

● PL1623BR

Plafon

LED: 15W

Lúmens: 1200lm

Temperatura: 3000K

Dimensões: Ø400 x A20 mm

Tensão: Bivolt (127V/220V)

Potência máxima: 15W

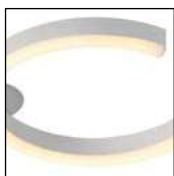

PL1622BR

Acabamento branco



PL1622PT

Acabamento preto

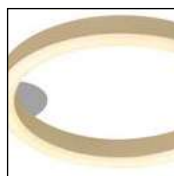

PL1622DO

Acabamento dourado



PL1623BR

Acabamento branco



PL1623PT

Acabamento preto



PL1623DO

Acabamento dourado

Rafik

Estrutura: Alumínio/Difusor de sílica gel

Difusor: Difusor branco

Acabamento: Branco, Preto ou Dourado

Canopla compacta exclusiva para forros de gesso



LED light

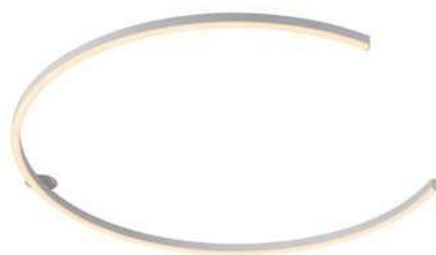
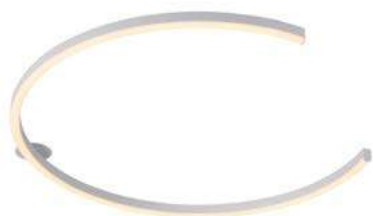

● PL1624BR

Plafon

LED: 25W

Lúmens: 2000lm

Temperatura: 3000K

Dimensões: Ø600 x A20 mm

Tensão: Bivolt (127V/220V)

Potência máxima: 25W

● PL1625BR

Plafon

LED: 30W

Lúmens: 2400lm

Temperatura: 3000K

Dimensões: Ø800 x A20 mm

Tensão: Bivolt (127V/220V)

Potência máxima: 30W



PL1624BR

Acabamento branco



PL1624PT

Acabamento preto



PL1624DO

Acabamento dourado



PL1625BR

Acabamento branco



PL1625PT

Acabamento preto



PL1625DO

Acabamento dourado

A

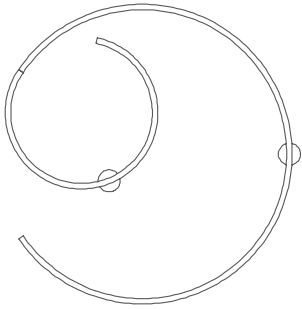

B

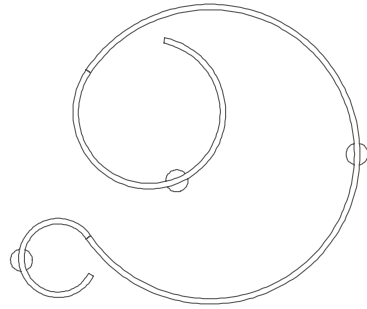

C

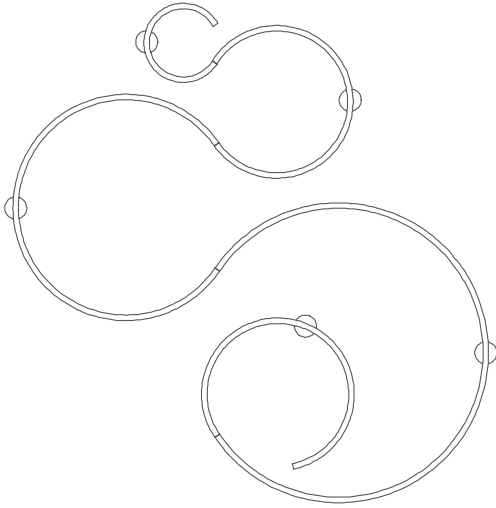

D

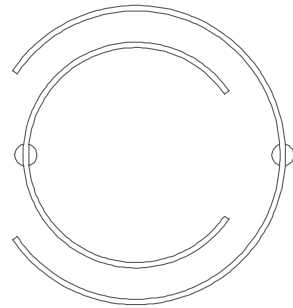

E

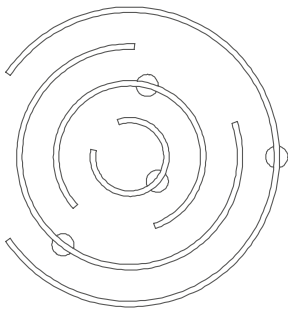

F

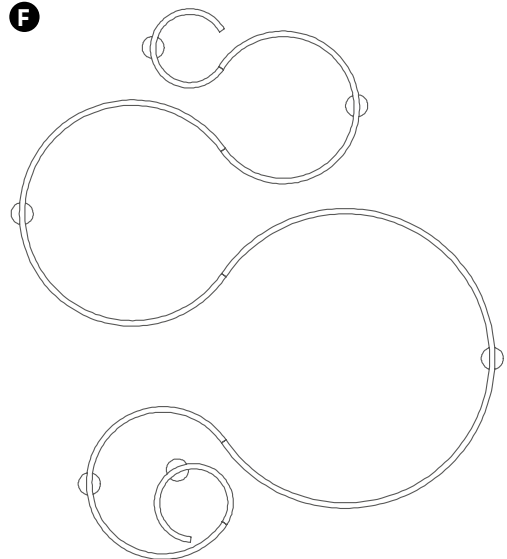

Tagne

Estrutura: Alumínio/Difusor de sílica gel

Difusor: Difusor branco

Acabamento: Branco, Preto e Dourado

Canopla compacta exclusiva para forros de gesso



PD1626PT

LED light



● PD1626PT

Pendente

LED: 24W

Lúmens: 1920lm

Temperatura: 3000K

Dimensões: C900 x L38 x A100 mm

Tensão: Bivolt (127V/220V)

Potência máxima: 24W

Cabo: 1500mm



PD1626BR

Acabamento branco

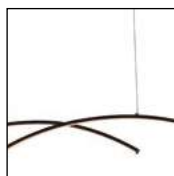

PD1626PT

Acabamento preto

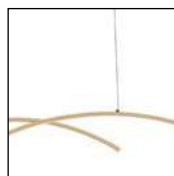

PD1626DO

Acabamento dourado

Mallen

Estrutura: Alumínio/Difusor de sílica gel

Difusor: Difusor branco

Acabamento: Branco, Preto e Dourado

Canopla compacta exclusiva para forros de gesso



PD1627PT

LED light

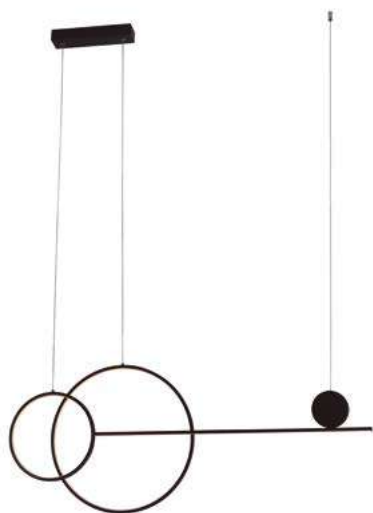

● PD1627PT

Pendente

LED: 36W

Lúmens: 2880lm

Temperatura: 3000K

Dimensões: C1200 x L38 x A200 mm

Tensão: Bivolt (127V/220V)

Potência máxima: 36W

Cabo: 1500mm

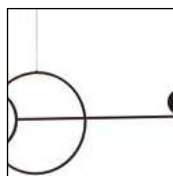

PD1627BR

Acabamento branco

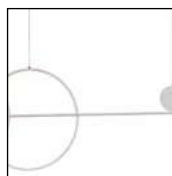

PD1627PT

Acabamento preto

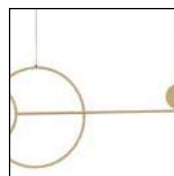

PD1627DO

Acabamento dourado

Orgon

Estrutura: Alumínio/Difusor de sílica gel

Difusor: Difusor branco

Acabamento: Branco, Preto, Dourado
ou Cobre



● **PD1424PT**

Pendente

LED: 45W

Lúmens: 2500lm

Temperatura: 3000K

Dimensões: Ø500 xA180 mm

Tensão: Bivolt (127V/220V)

Potência máxima: 45W

Cabo ajustável até 1500mm



PD1424BR

Acabamento branco

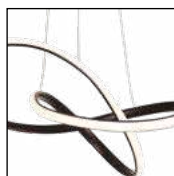

PD1424PT

Acabamento preto

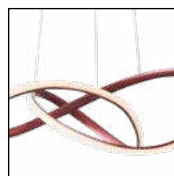

PD1424CO

Acabamento cobre

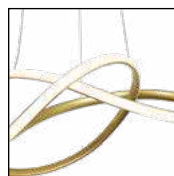

PD1424DO

Acabamento dourado



PD1623BR



● **PD1423CO**
Pendente

LED: 58W
Lúmens: 2800lm
Temperatura: 3000K
Dimensões: Ø800 xA180 mm
Tensão: Bivolt (127V/220V)
Potência máxima: 58W
Cabo ajustável até 1500mm

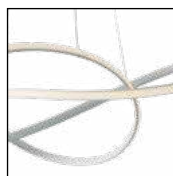

PD1423BR
Acabamento branco



PD1423PT
Acabamento preto

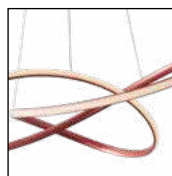

PD1423CO
Acabamento cobre

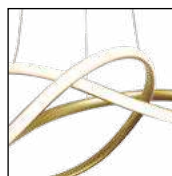

PD1423DO
Acabamento dourado

Lace

Estrutura: Alumínio/Difusor de sílica gel

Difusor: Difusor branco

Acabamento: Preto ou Dourado



LED light
A rainbow-colored bar is positioned below the text.



● PD1425PT

Pendente

LED: 36W

Lúmens: 1500lm

Temperatura: 3000K

Dimensões: C1000 x L250 x A250 mm

Tensão: Bivolt (127V/220V)

Potência máxima: 36W

Cabo ajustável até 1500mm



PD1425PT

Acabamento preto

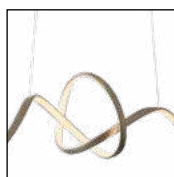

PD1425DO

Acabamento dourado

Worm

Estrutura: Alumínio/Difusor de sílica gel

Difusor: Difusor branco

Acabamento: Branco, Preto, Dourado
ou Cobre



PD1427DO



LED light



● AR1426BR

Arandela

LED: 10W

Lúmens: 770lm

Temperatura: 3000K

Dimensões: C160 x L140 x A320 mm

Tensão: Bivolt (127V/220V)

Potência máxima: 10W

● PD1427DO

Pendente

LED: 30W

Lúmens: 1300lm

Temperatura: 3000K

Dimensões: Ø180 x A550 mm

Tensão: Bivolt (127V/220V)

Potência máxima: 30W

Cabo ajustável até 1500mm



AR1426BR

Acabamento branco



AR1426PT

Acabamento preto



AR1426CO

Acabamento cobre



AR1426DO

Acabamento dourado



PD1427DO

Acabamento
dourado



PD1427PT

Acabamento preto

Quebec

LED light

Estrutura: Metal, detalhes em alumínio/

Difusor de sílica gel

Difusor: Difusor branco

Acabamento: Branco, Preto, Dourado
ou Cobre



● QPD1435CO

Pendente

LED: 45W

Lúmens: 1962lm

Temperatura: 3000K

Dimensões: Ø400+Ø500 x A20 mm

Tensão: Bivolt (127V/220V)

Potência máxima: 45W

Cabo ajustável até 1500mm



QPD1435BR
Acabamento branco



QPD1435PT
Acabamento preto

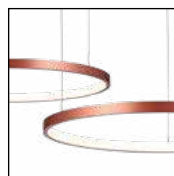

QPD1435CO
Acabamento cobre



QPD1435DO
Acabamento dourado



QPD1435PT

Quebec

LED light

Estrutura: Alumínio/Difusor de sílica gel

Difusor: Difusor branco

Acabamento: Branco, Preto, Dourado
ou Cobre

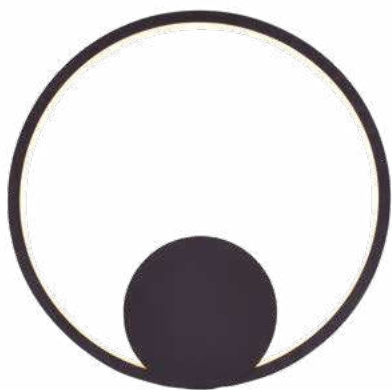

● **QAR1436PT**

Arandela/Plafon

LED: 15W

Lúmens: 650lm

Temperatura: 3000K

Dimensões: Ø300 mm

Tensão: Bivolt (127V/220V)

Potência máxima: 15W

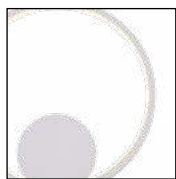

QPD1435BR
Acabamento branco

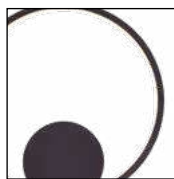

QPD1435PT
Acabamento preto



QPD1435CO
Acabamento cobre

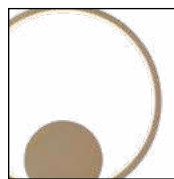

QPD1435DO
Acabamento dourado





Montreal

LED light

Estrutura: Alumínio/Difusor de sílica gel

Difusor: Difusor branco

Acabamento: Branco, Preto, Dourado
ou Cobre

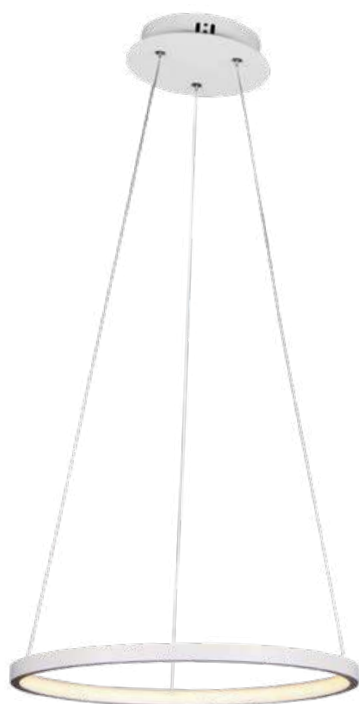

● **QPD1300-BR**

Pendente

LED: 20W

Lúmens: 1258lm

Temperatura: 3000K

Dimensões: Ø400 x A20 mm

Tensão: Bivolt (127V/220V)

Potência máxima: 20W

Cabo ajustável até 1500mm



QPD1300-BR
Acabamento branco



QPD1300-PT
Acabamento preto



QPD1300-CO
Acabamento cobre



QPD1300-DO
Acabamento dourado

Montreal

Estrutura: Alumínio/Difusor de sílica gel

Difusor: Difusor branco

Acabamento: Branco, Preto, Dourado
ou Cobre



QPPD1301-BR

LED light

● QPD1301-PT

Pendente

LED: 25W + 15W

Lúmens: 2254lm

Temperatura: 3000K

Dimensões: Ø500 + Ø300 x A20 mm

Tensão: Bivolt (127V/220V)

Potência máxima: 40W

Cabo ajustável até 1500mm



QPD1301-BR
Acabamento branco



QPD1301-PT
Acabamento preto

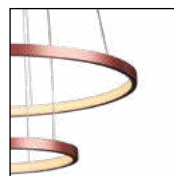

QPD1301-CO
Acabamento cobre



QPD1301-DO
Acabamento dourado

Montreal

LED light

Estrutura: Alumínio/Difusor de sílica gel

Difusor: Difusor branco

Acabamento: Branco, Preto, Dourado
ou Cobre



● QPD1303-DO

Pendente

LED: 24W + 30W + 35W

Lúmens: 4181lm

Temperatura: 3000K

Dimensões: Ø600 + Ø500 + Ø400 x A20 mm

Tensão: Bivolt (127V/220V)

Potência máxima: 89W

Cabo ajustável até 1500mm

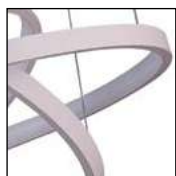

QPD1303-BR
Acabamento branco



QPD1303-PT
Acabamento preto



QPD1303-CO
Acabamento cobre



QPD1303-DO
Acabamento dourado



QPD1303-CO

Hoop

Estrutura: Alumínio/Difusor de sílica gel

Difusor: Difusor branco

Acabamento: Branco, Preto, Dourado
ou Cobre



QPD1321PT



LED light

● QPD1321BR Pendente

LED: 16W

Lúmens: 688lm

Temperatura: 3000K

Dimensões: C120 x A35 mm

Tensão: Bivolt (127V/220V)

Potência máxima: 16W

Cabo ajustável até 1500mm

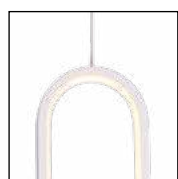

QPD1321BR
Acabamento branco



QPD1321PT
Acabamento preto

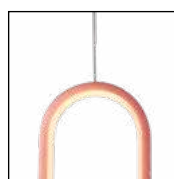

QPD1321CO
Acabamento cobre



QPD1321DO
Acabamento dourado

Twine

Estrutura: Alumínio/Difusor de sílica gel

Difusor: Difusor branco

Acabamento: Branco, Preto, Dourado
ou Cobre



QPD1339PT

LED light



● QPD1339DO Pendente

LED: 15W

Lúmens: 900lm

Temperatura: 3000K

Dimensões: C880 x A70 mm

Tensão: Bivolt (127V/220V)

Potência máxima: 15W

Cabo ajustável até 1500mm

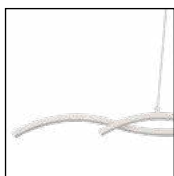

QPD1339BR

Acabamento branco

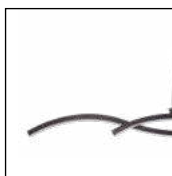

QPD1339PT

Acabamento preto

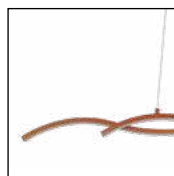

QPD1339CO

Acabamento cobre

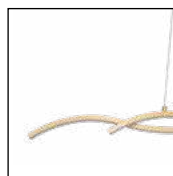

QPD1339DO

Acabamento dourado

Roof

Estrutura: Alumínio/Acrílico e aço inox

Difusor: Difusor branco

Acabamento: Cromada



LED light



● **AR803**
Arandela

LED: 8W
Lúmens: 321lm
Temperatura: 3000K
Dimensões: C452 x L45 x A125,8 mm
Tensão: Bivolt (127V/220V)
Potência máxima: 8W



● **AR804**
Arandela

LED: 12W
Lúmens: 554lm
Temperatura: 3000K
Dimensões: C595 x L45 x A125 mm
Tensão: Bivolt (127V/220V)
Potência máxima: 12W

Haus

Estrutura: Metal

Acabamento: Branco ou Preto



LED light



● AR1445PT

Arandela

1 x GU10 LED | 20W

Dimensões: C230 x L200 x A290 mm

Tensão: Bivolt (127V/220V)

Potência máxima: 20W



AR1445BR

Acabamento branco



AR1445PT

Acabamento preto

Cozy

Estrutura: Metal/Cúpula de tecido

Cúpula: Branco

Acabamento: Branco, Preto
ou Cromado



LED light

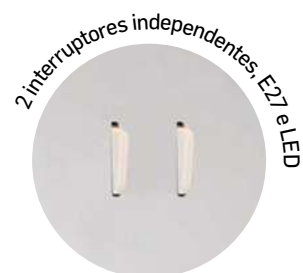

● QAR1337CR

Arandela

1 x E27 | 40W + LED 2W

Lúmens: 80lm

Temperatura: 3000K

Dimensões: C160 x L170 x A300 mm

Tensão: Bivolt (127V/220V)

Potência máxima: 16W

Cabo ajustável até 1500mm



QAR1337BR
Acabamento branco



QAR1337CR
Acabamento cro-
mado



QAR1337PT
Acabamento preto

Vision

Estrutura: Alumínio

Acabamento: Branco ou Prata ou Preto



AR1302-PT



LED light

Interruptor liga/desliga



● **AR1302-PR**
Arandela

LED: 3W
Lúmens: 300lm
Temperatura: 3000K
Dimensões: L85 x A455 mm
Tensão: Bivolt (127V/220V)
Potência máxima: 3W



AR1302-BR
Acabamento branco



AR1302-PR
Acabamento prata



AR1302-PT
Acabamento preto

Pipe

Estrutura: Alumínio

Acabamento: Branco ou Preto



LED light



Interruptor liga/desliga

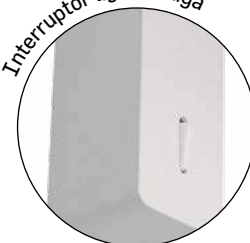

● AR1447BR

Arandela

LED: 3W

Lúmens: 300lm

Temperatura: 3000K

Dimensões: C130 x L37 x A95 mm

Tensão: Bivolt (127V/220V)

Potência máxima: 3W



AR1447BR

Acabamento branco



AR1447PT

Acabamento preto

Aniko

Estrutura: Alumínio
Acabamento: Branco ou Preto



AR1428BR

Arandela

1x E27 40W

Dimensões: C350 x L130 x A320 mm

Tensão: Bivolt (127V/220V)

Potência máxima: 40W

Possui cabo de 1500mm com interruptor liga e desliga para ser ligado a tomada



AR1428BR

Acabamento branco



AR1428PT

Acabamento preto



Post

Estrutura: Metal/ base de mármore/
cúpula de tecido

Cúpula: Tecido preto

Acabamento: Preto



● **CL1024**

Coluna

1xE27 40W

Dimensões: C500 x L1630 x A1980 mm

Cúpula: Ø360 / Ø490 x A260 mm

Tensão: Bivolt (127V/220V)

Potência máxima: 40W

Possui cabo de 2200mm com interruptor
liga e desliga para ser ligado a tomada



CL1024

Dome

Estrutura: Metal/ Cúpula de tecido

Cúpula: Branca

Acabamento: Cromado ou Cobre



PD948-CR



● **PD947-CR**

Pendente

1x E27 40W

Dimensões: Ø340 x A250 mm

Tensão: Bivolt (127V/220V)

Potência máxima: 40W

Haste 118mm



● **PD948-CO**

Pendente

2x E27 40W

Dimensões: Ø340 x A250 mm

Tensão: Bivolt (127V/220V)

Potência máxima: 80W

Haste 765mm



PD947-CR

Acabamento cromado

PD947-CO

Acabamento cobre



PD948-CR

Acabamento cromado

PD948-CO

Acabamento cobre

Spine

Estrutura: Metal

Acabamento: Preto, Cobre ou Dourado



● QPD1361DO

Pendente

6 x E27 | 40W

Dimensões: C700 x L165 x A220 mm

Tensão: Bivolt (127V/220V)

Potência máxima: 240W

Cabo ajustável até 1500mm



● QPD1607CO

Pendente

8 x E27 | 40W

Dimensões: C1100 x L165 x A212 mm

Tensão: Bivolt (127V/220V)

Potência máxima: 320W

Cabo ajustável até 1500mm



QPD1361PT
Acabamento preto

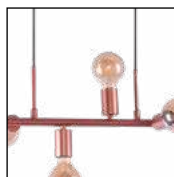

QPD1361CO
Acabamento cobre



QPD1361DO
Acabamento dourado



QPD1607PT
Acabamento preto

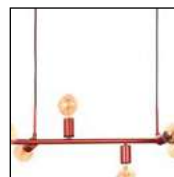

QPD1607CO
Acabamento cobre



QPD1607DO
Acabamento dourado



QPD1607PT

Arrow

Estrutura: Metal

Acabamento: Preto ou Marrom



● PD1310-CA

Pendente

6x E27 40W

Dimensões: Ø500 x A510 mm

Tensão: Bivolt (127V/220V)

Potência máxima: 240W

Cabo ajustável até 1500mm



PD1310-CA

Acabamento marrom/
detalhe cobre



PD1310-PT

Acabamento preto/
detalhe dourado



PD1310-CA

Cannon

Estrutura: Metal preto

Acabamento detalhe: Preto ou Dourado



PD1633DO

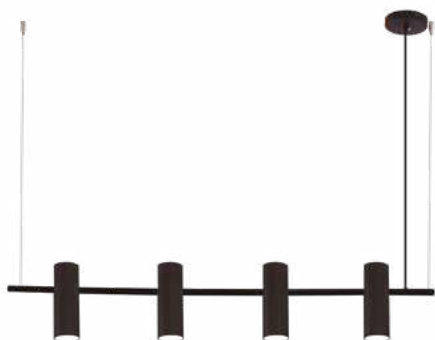

● PD1632

Pendente

4xGU10

Dimensões: C900 x L535 x A1000 mm

Tensão: Bivolt (127V/220V)

Potência máxima: W

Cabo ajustável de até 1500m

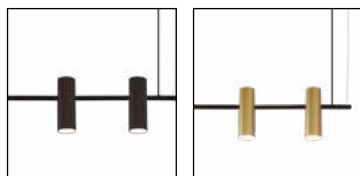

PD1632

Acabamento preto

PD1632DO

Acabamento dourado

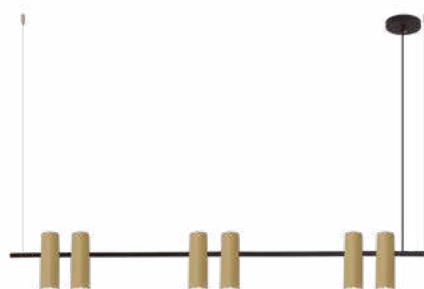

● PD1633DO

Pendente

6xGU10

Dimensões: C1100 x L160 x A1300 mm

Tensão: Bivolt (127V/220V)

Potência máxima: W

Cabo ajustável de até 1500m

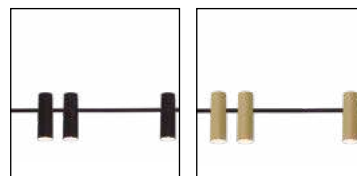

PD1633

Acabamento preto

PD1633DO

Acabamento dourado

Cluster

Estrutura: Metal

Acabamento: Preto ou Dourado



● QPD13224

Pendente

4 x E27 | 40W

Dimensões: Ø400 x A300 mm

Tensão: Bivolt (127V/220V)

Potência máxima: 160W

Cabo ajustável até 1500mm



● QPD13229

Pendente

9 x E27 | 40W

Dimensões: Ø660 x A530 mm

Tensão: Bivolt (127V/220V)

Potência máxima: 360W

Cabo ajustável até 1500mm



QPD13224

Acabamento preto

QPD13224DO

Acabamento dourado



QPD13229

Acabamento preto

QPD13229DO

Acabamento dourado



QPD13229D0

Torch

Estrutura: Metal

Acabamento: Preto com detalhe em cobre ou preto com detalhe em dourado



● QAR1349

Arandela

1 x E27 | 40W

Dimensões: C110 x L110 x A195 mm

Tensão: Bivolt (127V/220V)

Potência máxima: 40W



QAR1349
Acabamento preto/
detalhe cobre



QAR1349DO
Acabamento preto/
detalhe dourado



QAR1349

Trace

Estrutura: Metal

Acabamento: Preto com detalhes em cobre ou preto com detalhes em dourado



QAR1351



● QAR1350

Arandela

2 x E27 | 40W

Dimensões: C225 x L110 x A320 mm

Tensão: Bivolt (127V/220V)

Potência máxima: 80W



QAR1350

Acabamento preto/
detalhe cobre

QAR1350DO

Acabamento preto/
detalhe dourado



● QAR1351

Arandela

1 x E27 | 40W

Dimensões: C140 x L120 x A220 mm

Tensão: Bivolt (127V/220V)

Potência máxima: 40W



QAR1351

Acabamento preto/
detalhe cobre

QAR1351DO

Acabamento preto/
detalhe dourado

Kiev

Estrutura: Metal

Acabamento: Preto com detalhes em cobre



● QPL13156

Plafon

6 x E27 | 40W

Dimensões: Ø366 x A140 mm

Tensão: Bivolt (127V/220V)

Potência máxima: 24W



● QPL13154

Plafon

4 x E27 | 40W

Dimensões: C320 x L210 x A140 mm

Tensão: Bivolt (127V/220V)

Potência máxima: 160W



● QPD131412

Pendente

12 x E27 | 40W

Dimensões: Ø430 x A310 mm

Tensão: Bivolt (127V/220V)

Potência máxima: 480W

Cabo ajustável até 1500mm



QPD131412



● **QPD131418**
Pendente

18 x E27 | 40W
Dimensões: Ø545 x A515 mm
Tensão: Bivolt (127V/220V)
Potência máxima: 720W
Cabo ajustável até 1500mm



● **QPD13149**
Pendente

9 x E27 | 40W
Dimensões: Ø430 x A310 mm
Tensão: Bivolt (127V/220V)
Potência máxima: 360W
Cabo ajustável até 1500mm

Globe

Estrutura: Metal

Acabamento: Preto com detalhe em cobre



● **PD1138**
Pendente

1 x E27 | 40W
Dimensões: Ø300 x A320 mm
Tensão: Bivolt (127V/220V)
Potência máxima: 40W
Cabo ajustável até 1500mm



PD1139



● **PD1139**
Pendente

1 x E27 | 40W
Dimensões: Ø400 x A420 mm
Tensão: Bivolt (127V/220V)
Potência máxima: 40W
Cabo ajustável até 1500mm



● **PD1140**
Pendente

1 x E27 | 40W
Dimensões: Ø500 x A520 mm
Tensão: Bivolt (127V/220V)
Potência máxima: 40W
Cabo ajustável até 1500mm

Manner

Estrutura: Metal
Acabamento: Preto



PD852



● **PD852**
Pendente

1 x E27 | 40W
Dimensões: Ø295 x A350 mm
Tensão: Bivolt (127V/220V)
Potência máxima: 40W
Cabo ajustável até 1500mm

Tine

Estrutura: Metal

Acabamento: Preto com detalhes
em cobre



● **PD644**
Pendente

3 x E27 | 40W
Dimensões: C550 x L190 x A180 mm
Tensão: Bivolt (127V/220V)
Potência máxima: 120W
Cabo ajustável até 1500mm



● **PD645**
Pendente

5 x E27 | 40W
Dimensões: C920 x L200 x A200 mm
Tensão: Bivolt (127V/220V)
Potência máxima: 200W
Cabo ajustável até 1500mm



PD644

Ivory

Estrutura: Metal

Acabamento: Preto com detalhes em cobre



● **PD642**
Pendente

1 x E27 | 40W
Dimensões: L200 x A200 mm
Tensão: Bivolt (127V/220V)
Potência máxima: 40W
Cabo ajustável até 1500mm



● **PD641**
Pendente

3 x E27 | 40W
Dimensões: L300 x A450 mm
Tensão: Bivolt (127V/220V)
Potência máxima: 120W
Cabo ajustável até 1500mm



PD641



● **PD643**
Pendente

6 x E27 | 40W
Dimensões: L500 x A800 mm
Tensão: Bivolt (127V/220V)
Potência máxima: 240W
Cabo ajustável até 1500mm

Mystic

Estrutura: Metal
Acabamento: Cobre



● **PD1112-CO**
Pendente

1 x E27 | 40W
Dimensões: Ø250 x A260 mm
Tensão: Bivolt (127V/220V)
Potência máxima: 40W
Cabo ajustável até 1500mm



PD1112-CO

Nice

Estrutura: Metal

Acabamento: Preto ou Cobre



● QPD919-CO

Pendente

1 x E27 | 40W

Dimensões: Ø150 x A200 mm

Tensão: Bivolt (127V/220V)

Potência máxima: 40W

Cabo ajustável até 1500mm



QPD919-CO

Acabamento preto/
detalhe cobre



QPD919-PT

Acabamento preto/
detalhe dourado



QPD919-PT

Lockup

Estrutura: Metal e Concreto

Acabamento: Preto



PD707



● **PD706**
Pendente

1 x E27 | 40W
Dimensões: Ø125 x A390 mm
Tensão: Bivolt (127V/220V)
Potência máxima: 40W
Cabo ajustável até 1500mm



● **PD707**
Pendente

1 x E27 | 40W
Dimensões: Ø260 x A300 mm
Tensão: Bivolt (127V/220V)
Potência máxima: 40W
Cabo ajustável até 1500mm

Jubile

Estrutura: Metal e Concreto

Acabamento: Cobre



● **PD1127**
Pendente

1 x E27 | 40W
Dimensões: Ø180 x A195 mm
Tensão: Bivolt (127V/220V)
Potência máxima: 40W
Cabo ajustável até 1500mm



● **PD1128**
Pendente

1 x E27 | 40W
Dimensões: Ø300 x A220 mm
Tensão: Bivolt (127V/220V)
Potência máxima: 40W
Cabo ajustável até 1500mm



PD1128

Sling

Estrutura: Concreto

Acabamento: Concreto



● **PD709**
Pendente

1 x E27 | 40W
Dimensões: Ø160 x A180 mm
Tensão: Bivolt (127V/220V)
Potência máxima: 40W
Cabo ajustável até 1500mm



PD709

Cover

Estrutura: Madeira ou Concreto
Acabamento: Madeira ou Concreto
Cabo: Preto



● **PD750**
Pendente

1 x E27 | 40W
Dimensões: Ø45 x A90 mm
Tensão: Bivolt (127V/220V)
Potência máxima: 40W
Cabo ajustável até 1500mm



● **PD751**
Pendente

1 x E27 | 40W
Dimensões: Ø45 x A90 mm
Tensão: Bivolt (127V/220V)
Potência máxima: 40W
Cabo ajustável até 1500mm

Halter

Estrutura: Corda

Acabamento: Natural



● **PD712**
Pendente

1 x E27 | 40W
Dimensões: Ø35 x A1500 mm
Tensão: Bivolt (127V/220V)
Potência máxima: 40W
Cabo ajustável até 1500mm

Askin

Estrutura: Metal

Acabamento: Branco, Marrom ou Preto
com detalhes em cobre



● QPD1161-PT

Pendente

1 x E27 | 40W

Dimensões: Ø300 x A335 mm

Tensão: Bivolt (127V/220V)

Potência máxima: 40W

Cabo ajustável até 1500mm



QPD1161-BR
Acabamento branco



QPD1161-MR
Acabamento marrom
detalhe cobre



QPD1161-PT
Acabamento preto
detalhe cobre



QPD1161-BR



Beaver

Estrutura: Metal

Acabamento: Branco com detalhe em aço escovado/ Preto com detalhe em cobre



com interruptor
liga/desliga

● AR862-BR

Arandela

1 x E27 | 40W

Dimensões: C165 x L530 x A700 mm

Tensão: Bivolt (127V/220V)

Potência máxima: 40W



AR862-BR

Acabamento branco
detalhe aço
escovado



AR862-MR

Acabamento preto
detalhe cobre



● LM860-PT

Luminária de mesa

1 x E27 | 40W

Dimensões: C230 x L550 x A745 mm

Tensão: Bivolt (127V/220V)

Potência máxima: 40W

Possui cabo de 1500mm com interruptor
liga e desliga para ser ligado a tomada



LM860-BR

Acabamento branco
detalhe aço
escovado



LM860-PT

Acabamento preto
detalhe cobre



● **CL861-BR**
Coluna

1 x E27 | 40W
Dimensões: C250 x L1700 x A550 mm
Tensão: Bivolt (127V/220V)
Potência máxima: 40W
Possui cabo de 1500mm com interruptor
liga e desliga para ser ligado a tomada



CL861-BR
Acabamento branco
detalhe aço escovado



CL861-PT
Acabamento preto
detalhe cobre



CL861-PT

Bergen

Estrutura: Metal

Acabamento: Preto com detalhe cromado



● QCL1152-PT

Coluna

1 x E27 | 40W

Dimensões: C340 x L205 x A1320 mm

Tensão: Bivolt (127V/220V)

Potência máxima: 40W

Possui cabo de 1800mm com interruptor liga e desliga para ser ligado a tomada



Bergen

Estrutura: Metal

Acabamento: Branco com detalhe cromado / Preto com detalhe cobre



com interruptor
liga/desliga

● QAR1153-BR

Arandela

1 x E27 | 40W

Dimensões: C225 x L120 x A170 mm

Tensão: Bivolt (127V/220V)

Potência máxima: 40W



QAR1153-BR

Acabamento branco
detalhe cromado



QAR1153-PT

Acabamento preto
detalhe cobre



● QPD1158-PT

Pendente

1 x E27 | 40W

Dimensões: Ø170 x A180 mm

Tensão: Bivolt (127V/220V)

Potência máxima: 40W

Cabo ajustável até 1500mm



QPD1158-BR

Acabamento branco
detalhe cromado



QPD1158-PT

Acabamento preto
detalhe cobre

Vega

Estrutura: Metal

Acabamento: Branco, Marrom ou Preto
com detalhe em cobre



● QAR1483-PT

Arandela

1 x E27 | 40W

Dimensões: C279 x L206 x A202 mm

Tensão: Bivolt (127V/220V)

Potência máxima: 40W



QPD1163-PT



● QPD1163-BR

Pendente

1 x E27 | 40W

Dimensões: Ø200 x A160 mm

Tensão: Bivolt (127V/220V)

Potência máxima: 40W

Cabo ajustável até 1500mm



QPD1163-BR

Acabamento branco
detalhe cobre



QPD1163-MR

Acabamento preto
detalhe cobre



QPD1163-PT

Acabamento preto
detalhe cobre

Hamar

Estrutura: Metal

Acabamento: Branco ou Cinza com detalhe em cobre



com interruptor
liga/desliga

● QAR1154-BR

Arandela

1 x E27 | 40W

Dimensões: C335 x L190 x A210 mm

Tensão: Bivolt (127V/220V)

Potência máxima: 40W



QAR1154-BR
Acabamento branco
detalhe cobre



QAR1154-CZ
Acabamento cinza
detalhe cobre



QAR1154-CZ

Helmet

Estrutura: Metal

Acabamento: Branco com detalhes em aço escovado / Preto com detalhes em cobre

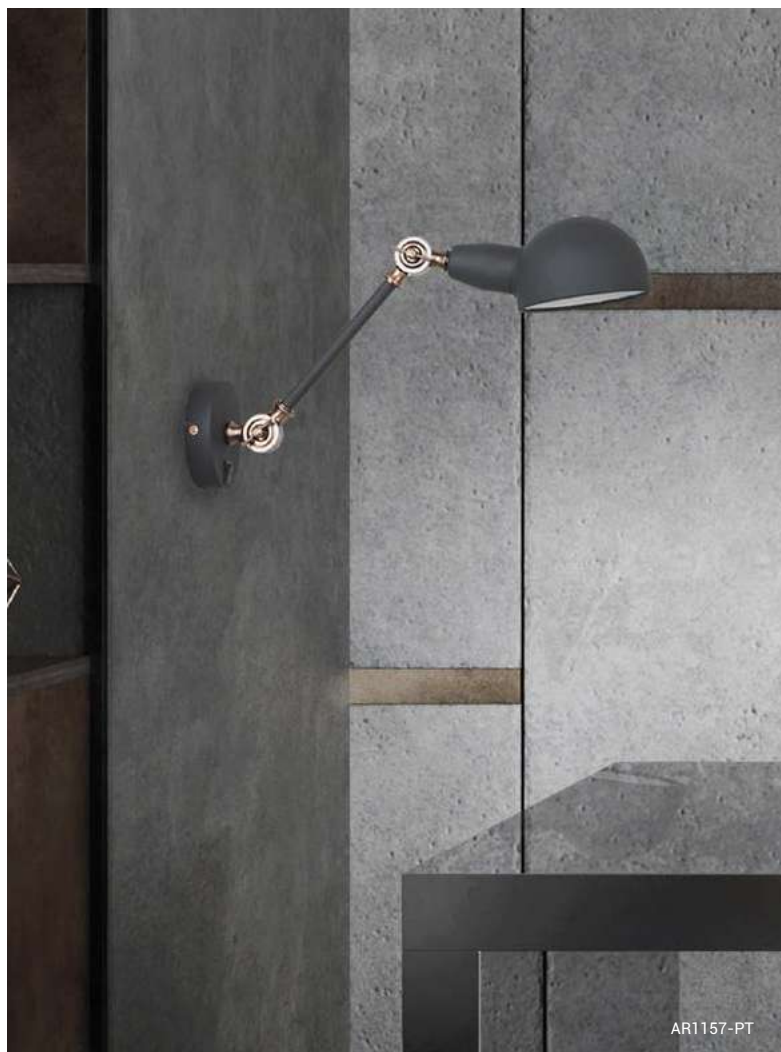

● AR1157-BR

Arandela

1 x E27 | 40W

Dimensões: C120 x L370 x A295 mm

Tensão: Bivolt (127V/220V)

Potência máxima: 40W



com interruptor
liga/desliga



AR1157-BR

Acabamento branco/
detalhe aço escovado

AR1157-PT

Acabamento preto/
detalhe cobre

Brande

Estrutura: Metal

Acabamento: Branco com detalhes cromado / Preto com detalhes cobre



● QLM1160-BR

Luminária de mesa

1 x E27 | 40W

Dimensões: C390 x L150 x A520 mm

Tensão: Bivolt (127V/220V)

Potência máxima: 40W

Possui cabo de 150cm com interruptor liga e desliga para ser ligado a tomada



QLM1160-BR

Acabamento branco/
detalhe cromado

QPD919-PT

Acabamento preto/
detalhe cobre



Horn

Estrutura: Metal/ Madeira

Madeira: Natural

Acabamento: Branco ou preto



● QLM1064-BR

Luminária de mesa

1 x G9 | 5W

Dimensões: L180 x A490 mm

Base: Ø140

Tensão: Bivolt (127V/220V)

Potência máxima: 5W

Possui cabo de 1500mm com interruptor liga e desliga para ser ligado a tomada



QLM1064-BR
Acabamento branco



QLM1064-PT
Acabamento preto

Horn

Estrutura: Metal/ Madeira
Madeira: Natural
Acabamento: Branco, Preto, Aço
Escovado ou Cobre



● QPD1063-PT

Pendente

1 x G9 | 5W
Dimensões: Ø125 x A190 mm
Tensão: Bivolt (127V/220V)
Potência máxima: 5W
Cabo ajustável até 1500mm



QPD1063-PT



QPD1063-BR
Acabamento branco



QPD1063-AE
Acabamento aço
escovado



QPD1063-CO
Acabamento cobre



QPD1063-PT
Acabamento preto

Horn

Estrutura: Metal/ Madeira
Madeira: Natural
Acabamento: Branco, Preto, Aço
Escovado ou Cobre



● QAR1457AE

Arandela

1 x G9 | 5W

Dimensões: L125 x C230 x A360 mm

Tensão: Bivolt (127V/220V)

Potência máxima: 5W

Possui cabo de 1500mm com interruptor liga e desliga para ser ligado a tomada



QAR1457PT



QAR1457BR
Acabamento branco



QAR1457AE
Acabamento aço escovado



QAR1457CO
Acabamento cobre



QAR1457PT
Acabamento preto



Horn

Estrutura: Metal/ Madeira

Madeira: Natural

Acabamento: Branco, Preto, Aço

Escovado ou Cobre



● QAR1466CO

Arandela

1 x G9 | 5W

Dimensões: L125 x C180 x A190 mm

Tensão: Bivolt (127V/220V)

Potência máxima: 5W



QAR1466BR
Acabamento branco



QAR1466AE
Acabamento aço
escovado

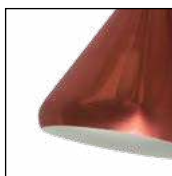

QAR1466CO
Acabamento cobre



QAR1466PT
Acabamento preto

Horn

Estrutura: Metal/ Madeira
Madeira: Natural
Acabamento: Branco, Preto, Aço
Escovado ou Cobre



QAR1457PT

● QCL1467AE

Coluna

1 x G9 | 5W

Dimensões: L230 x C240 x A1400 mm

Tensão: Bivolt (127V/220V)

Potência máxima: 5W

Possui cabo de 1500mm com interruptor liga e desliga para ser ligado a tomada



QCL1467BR
Acabamento branco



QCL1467AE
Acabamento aço escovado



QCL1467CO
Acabamento cobre



QCL1467PT
Acabamento preto

Nexus

Estrutura: Metal

Acabamento: Aço escovado ou Cobre



● LM1060-CO

Arandela

1 x E27 | 40W

Dimensões: Ø135 x A530 mm

Tensão: Bivolt (127V/220V)

Potência máxima: 40W

Possui cabo de 1500mm com interruptor liga e desliga para ser ligado a tomada



LM1060-AE
Acabamento aço escovado



LM1060-CO
Acabamento cobre

Kono

LANÇAMENTO 2022

Estrutura: Alumínio/Acrílico/ Borracha
Acabamento: Branco ou Cromada



● **AB1741CR**
Abajur

LED 2x 5V
Lúmens: 400lm
Temperatura: 3000K RGB
Dimensões: Ø150 C110 x L110 x A390 mm
Tensão: Bivolt (127V/220V)
Potência máxima: 2.5W
Recarregável com USB



AB1741BR



AB1741CR



AB1741CR

Orla

LANÇAMENTO 2022

Estrutura: Alumínio / Vidro
Difusor: Branco opalino
Acabamento: Preto, Dourado ou Branco



● AB1762PT

Abajur

1x G9 5W

Dimensões: Ø150 x A405 mm

Tensão: Bivolt (127V/220V)

Potência máxima: 5W

Possui cabo de 1500mm com interruptor liga e desliga para ser ligado a tomada



AB1762BR



AB1762PT



AB1762DO

Mizo

LANÇAMENTO 2022

Estrutura: Plástico
Acabamento: Preto ou Branco

Carregamento por USB
Acendimento e dimerização por touch
direcionável



● **AB1766BR**
Abajur

LED 5W
Lúmens: 400lm
Temperatura: 3000K
Dimensões: Ø140 x A218 mm
Tensão: Bivolt (127V/220V)
Potência máxima: 5W
Voltagem: 5V



AB1766BR
acabamento branco



AB1766PT
acabamento preto



Carregamento por USB

Krio

LANÇAMENTO 2022

Estrutura: Alumínio
Acabamento: Preto, Dourado ou Branco



● AB1763PT

Abajur

2x G9 LED 5W
Dimensões: Ø250 x A365 mm
Tensão: Bivolt (127V/220V)
Potência máxima: 10W
Possui cabo de 1500mm com interruptor liga e desliga para ser ligado a tomada



AB1763BR
acabamento branco



AB1763PT
acabamento preto



AB1763DO
acabamento dourado

Potter

Estrutura: Cerâmica

Cúpula: Branco ou Preto



● **QAB1454PT**

Abajur

1 x E27 | 40W

Dimensões: Ø150 x A320 mm

Tensão: Bivolt (127V/220V)

Potência máxima: 40W

Possui cabo de 1200mm com interruptor liga e desliga para ser ligado a tomada



QAR1454BR
Acabamento branco



QAR1454PT
Acabamento preto





QAR1454BR

Milão

Estrutura: Cerâmica/ Cúpula tecido

Cúpula: Cinza

Acabamento: Cinza



● QAB915-CZ

Abajur

1 x E27 | 40W

Dimensões: Ø200 x A240 mm

Tensão: Bivolt (127V/220V)

Potência máxima: 40W

Possui cabo de 1500mm com interruptor liga e desliga para ser ligado a tomada

Verona

Estrutura: Cerâmica / Cúpula de tecido

Cúpula: Bege ou Preto

Acabamento: Base bege ou Base preta



● QAB916-BG

Abajur

1 x E27 | 40W

Dimensões: Ø160 x A330 mm

Tensão: Bivolt (127V/220V)

Potência máxima: 40W

Possui cabo de 1500mm com interruptor liga e desliga para ser ligado a tomada



QAB916-BG
Acabamento bege



QAB916-PT
Acabamento preto



QAB916-PT

Sicília

Estrutura: Cerâmica/ Cúpula tecido

Cúpula: Bege ou Preta

Acabamento: Bege ou Preta



QAB914-PT

● QAB914-PT

Abajur

1 x E27 | 40W

Dimensões: Ø150 x A300 mm

Tensão: Bivolt (127V/220V)

Potência máxima: 40W

Possui cabo de 1500mm com interruptor liga e desliga para ser ligado a tomada



QAB914-BG
Acabamento bege



QAB914-PT
Acabamento preto

Turret

Estrutura: Metal / Cúpula de tecido

Cúpula: Branco ou Preto

Acabamento: Base dourada,

Base níquel ou Base cobre



● QAB1068-DO

Abajur

1 x E27 | 40W

Dimensões: Ø200 x A365 mm

Tensão: Bivolt (127V/220V)

Potência máxima: 40W

Possui cabo de 1500mm com interruptor liga e desliga para ser ligado a tomada



● QAB1069-BR

Abajur

1 x E27 | 40W

Dimensões: Ø200 x A365 mm

Tensão: Bivolt (127V/220V)

Potência máxima: 40W

Possui cabo de 1500mm com interruptor liga e desliga para ser ligado a tomada



QAB1069-BR



QAB1069-BR

Acabamento níquel /
cúpula branca



QAB1069-PT

Acabamento cobre /
cúpula preta

Tack

Estrutura: Metal / Cúpula tecido

Cúpula: Branco / Preto

Acabamento: Dourado / Níquel / Preto



● QAB1066-DO

Abajur

1 x E27 | 40W

Dimensões: Ø160 x A290 mm

Tensão: Bivolt (127V/220V)

Potência máxima: 40W

Possui cabo de 1500mm com interruptor liga e desliga para ser ligado a tomada



● QAB1067-BR

Abajur

1 x E27 | 40W

Dimensões: Ø160 x A290 mm

Tensão: Bivolt (127V/220V)

Potência máxima: 40W

Possui cabo de 1500mm com interruptor liga e desliga para ser ligado a tomada



QAB1067-BR

Acabamento níquel /
cúpula branca



QAB1067-PT

Acabamento cobre /
cúpula preto

Tint

Estrutura: Concreto

Cúpula (QAB1374): Tecido

Acabamento: Base cinza com detalhe em cobre ou Base preta com detalhe em dourado



QAB1374CO



● QAB1375CO

Abajur

1 x E27 | 40W

Dimensões: Ø90 x A120 mm

Tensão: Bivolt (127V/220V)

Potência máxima: 40W

Possui cabo de 1500mm com interruptor liga e desliga para ser ligado a tomada



● QAB1374DO

Abajur

1 x E27 | 40W

Dimensões: Ø180 x A371 mm

Tensão: Bivolt (127V/220V)

Potência máxima: 40W

Possui cabo de 1500mm com interruptor liga e desliga para ser ligado a tomada



QAB1075CO

Base cinza
Detalhe cobre



QAB1075DO

Base preta
Detalhe dourado



QAB1069-BR

Base cinza
detalhe cobre
cúpula branca



QAB1069-PT

Base preta
detalhe dourado
cúpula preta

ENDLESS POSSIBILITIES



Introdução



406

Módulo de metal
para sistema



410

Componentes



412

Driver



415

Pendente
para módulo



416

Trilhos/
Componentes



418

Kits Magnetic

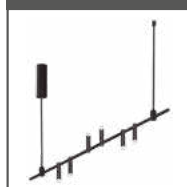

420

Tabela
Códigos e itens

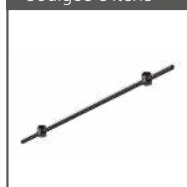

422



Modular
Magnetic
System



O sistema magnético modular Studioluce apresenta uma nova maneira de iluminar: Moderna e prática, munida com o melhor da tecnologia. Liberdade de escolha, desde o tamanho e altura do trilho até os módulos de luminárias, que podem ser combinados para a melhor composição de design e resultado luminotécnico. Escolha. Combine. Ilumine!



Design inovador
Variedade de acessórios e módulos
Possibilidade de montagens diversificadas



Fácil
instalação
com
**fixação
magnética**

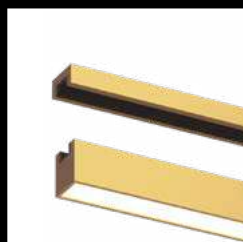

Modular **Magnetic** System

Bivolt 100-240V

Sistema 24V

Potência máxima 100W

Não possui fios

Fixação magnética

Crie seu próprio design

Fontes luminosas, podem ser posicionadas em
qualquer parte do trilho, para cima ou para baixo



SST1383	
Dim. (mm)	Ø60 x A107
Potência	5W
Tem. Cor	3000k
Voltagem	24V
Fluxo (lm)	200 lm
IRC	>90
Material	Alumínio + Acrílico
Acabamento	Dourado / Preto
Garantia	3 anos

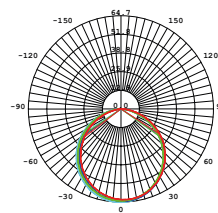
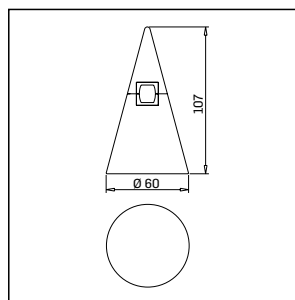

- SST1383DO
- SST1383PT



SST1384	
Dim. (mm)	Ø100 x A142
Potência	5W
Tem. Cor	3000k
Voltagem	24V
Fluxo (lm)	200 lm
IRC	>90
Material	Alumínio + Vidro
Acabamento	Dourado / Preto
Garantia	3 anos

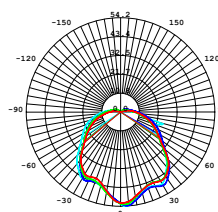
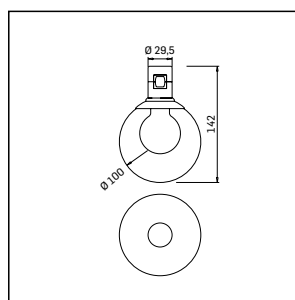

- SST1384DO
- SST1384PT



SST1385

Dim. (mm)	Ø29,5 x 149
Potência	5W
Tem. Cor	3000k
Voltagem	24V
Fluxo (lm)	200 lm
IRC	>90
Material	Alumínio + Acrílico
Acabamento	Dourado / Preto
Garantia	3 anos

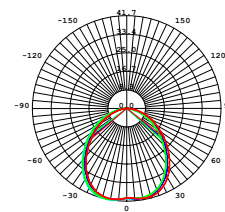
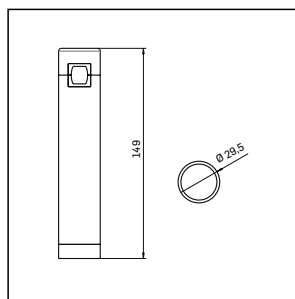

- SST1385DO
- SST1385PT



SST1387

Dim. (mm)	250 x 26 x 44
Potência	10W
Tem. Cor	3000k
Voltagem	24V
Fluxo (lm)	492 lm
IRC	>90
Material	Alumínio + Acrílico
Acabamento	Dourado / Preto
Garantia	3 anos

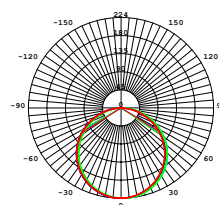
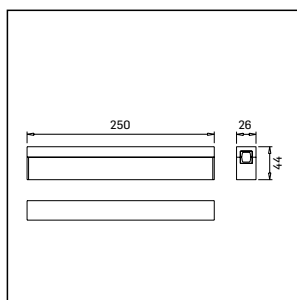

- SST1387DO
- SST1387PT



PORTA DRIVER

BST1391

Dim. (mm) Ø70 x A350

Material Alumínio

Acabamento Dourado / Preto

Garantia 3 anos

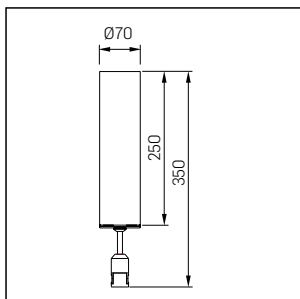

- BST1391DO
- BST1391PT

PORTA DRIVER

BST1392

Dim. (mm) Ø70 x A730

Material Alumínio

Acabamento Dourado / Preto

Garantia 3 anos

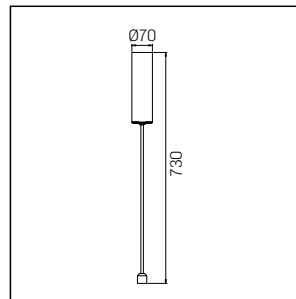

- BST1392DO
- BST1392PT

HASTE INTERMEDIÁRIA

TST1396

Dim. (mm) Ø20 x A280

Material Alumínio

Acabamento Dourado / Preto

Garantia 3 anos

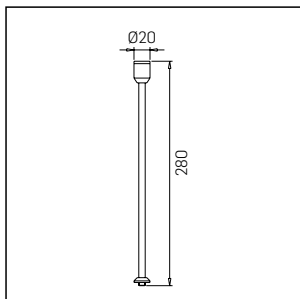

- TST1396DO
- TST1396PT

HASTE INTERMEDIÁRIA

TST1397

Dim. (mm) Ø20 x A684

Material Alumínio

Acabamento Dourado / Preto

Garantia 3 anos

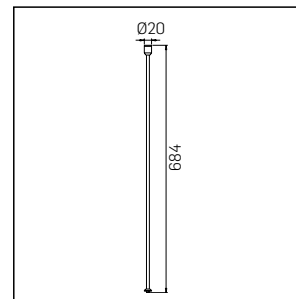

- TST1397DO
- TST1397PT

HASTE TERMINAL

TST1398

Dim. (mm) Ø29,5 x A326

Material Alumínio

Acabamento Dourado / Preto

Garantia 3 anos

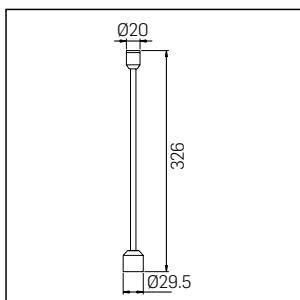

- TST1398DO
- TST1398PT

HASTE TERMINAL

TST1398P

Dim. (mm) Ø29,5 x A278

Material Alumínio

Acabamento Dourado / Preto

Garantia 3 anos

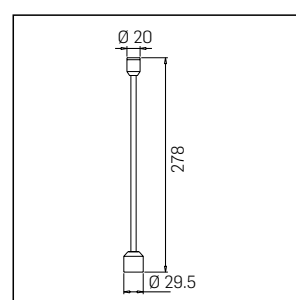

- TST1398PDO
- TST1398PPT

HASTE TERMINAL

TST1399
Dim. (mm) Ø29,5 x A730
Material Alumínio
Acabamento Dourado / Preto
Garantia 3 anos

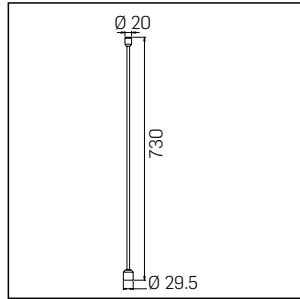

- TST1399DO
- TST1399PT

HASTE TERMINAL

TST1399P
Dim. (mm) Ø29,5 x A682
Material Alumínio
Acabamento Dourado / Preto
Garantia 3 anos

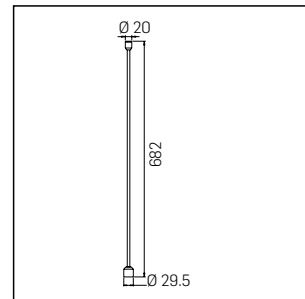

- TST1399PDO
- TST1399PPT

TRILHO

TST1393
Dim. (mm) C1000 x A33,2
Material Alumínio
Acabamento Dourado / Preto
Garantia 3 anos

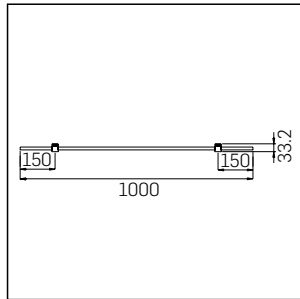

- TST1393DO
- TST1393PT

TRILHO

TST1394
Dim. (mm) C1000 x A53
Material Alumínio
Acabamento Dourado / Preto
Garantia 3 anos

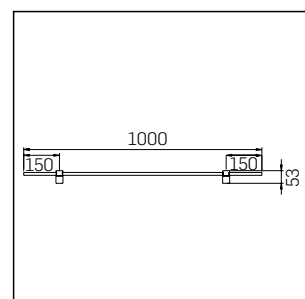

- TST1394DO
- TST1394PT

TRILHO

TST1395
Dim. (mm) C1000 x A59,2
Material Alumínio
Acabamento Dourado / Preto
Garantia 3 anos

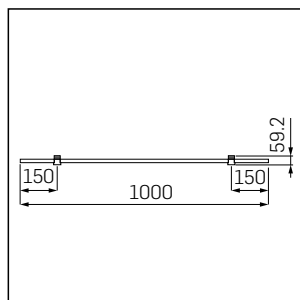

- TST1395DO
- TST1395PT

TRILHO

TST1477
Dim. (mm) C1500 x A33,2
Material Alumínio
Acabamento Dourado / Preto
Garantia 3 anos

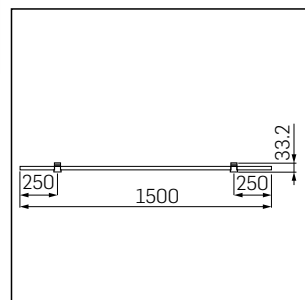

- TST1477DO
- TST1477PT

TRILHO

TST1478

Dim. (mm)	C1500 x A53
Material	Alumínio
Acabamento	Dourado / Preto
Garantia	3 anos

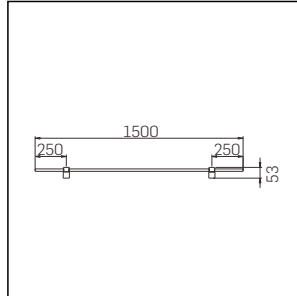

- TST1478DO
- TST1478PT

TRILHO

TST1479

Dim. (mm)	C1500 x A59,2
Material	Alumínio
Acabamento	Dourado / Preto
Garantia	3 anos

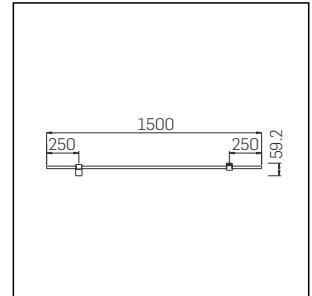

- TST1479DO
- TST1479PT

TRILHO

TST1480

Dim. (mm)	C2000 x A33,2
Material	Alumínio
Acabamento	Dourado / Preto
Garantia	3 anos

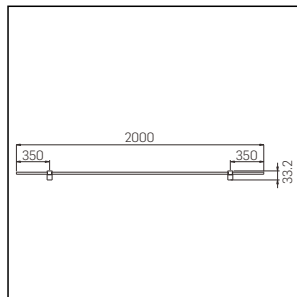

- TST1480DO
- TST1480PT

TRILHO

TST1481

Dim. (mm)	C2000 x A53
Material	Alumínio
Acabamento	Dourado / Preto
Garantia	3 anos

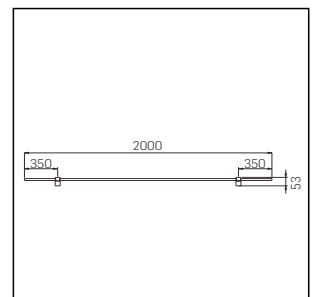

- TST1481DO
- TST1481PT

TRILHO

TST1482

Dim. (mm)	C2000 x A59,2
Material	Alumínio
Acabamento	Dourado / Preto
Garantia	3 anos

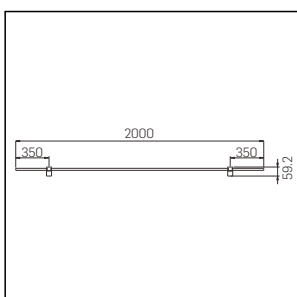

- TST1482DO
- TST1482PT

Driver compatível com
Modular Magnetic System



DST1390

Potência	100W
Voltagem	24V

DST1390-100W R\$ 296,40

Drivers Newline compatíveis
FT00002- 50W
FT00003- 100W



PST1389

Dim. (mm) Ø800 x 1200

Material Alumínio

Acabamento Dourado / Preto

Garantia 3 anos

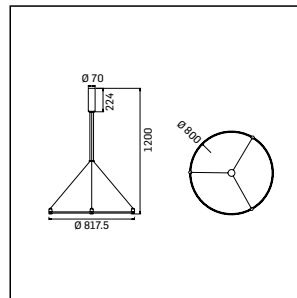

- PST1389DO
- PST1389PT





TRILHOS/COMPONENTES

● Sistema curto

● Sistema longo

● Componente utilizado apenas em sistemas com número par de trilhos

■ DRIVER



DST1390-60W



DST1390-100W

■ PORTA DRIVER



BST1391PT

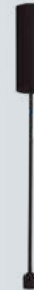

BST1392PT



■ HASTE INTERMEDIÁRIA

Utilizada entre o porta driver e a haste terminal em todos os sistemas com mais de 1 trilho



TST1396PT



TST1397PT



TST1398PT



TST1398PPT



TST1399PT



TST1399PPT



■ TRILHO

1000mm



TST1393PT



TST1394PT



TST1395PT



1500mm



TST1477PT



TST1478PT



TST1479PT



2000mm



TST1480PT



TST1481PT



TST1482PT





KITS Magnetic



● K1M3SPDO
● K1M3SPPT
1000 x 730 mm
Módulo: SST1385
Driver: DST1390-60W



● K15M4SPDO
● K15M4SPPT
1500 x 730 mm
Módulo: SST1385
Driver: DST1390-60W

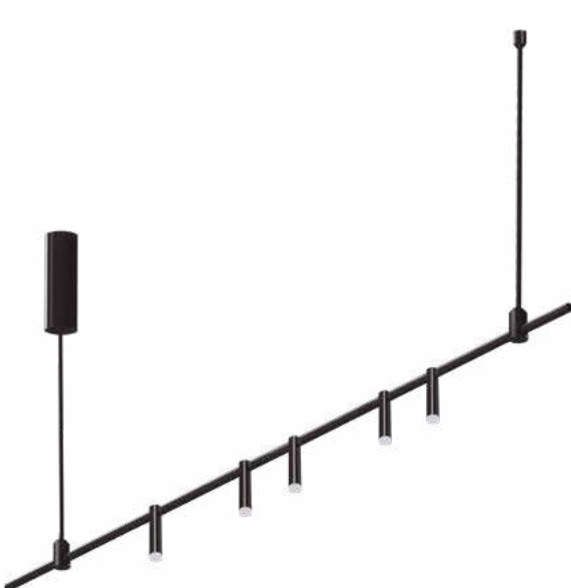

● K2M5SPDO
● K2M5SPPT
2000 x 730 mm
Módulo: SST1385
Driver: DST1390-60W



● K1M3ESDO
● K1M3ESPT
1000 x 730 mm
Módulo: SST1384
Driver: DST1390-60W



● K15M4ESDO
● K15M4ESPT
1500 x 730 mm
Módulo: SST1384
Driver: DST1390-60W



● K2M5ESDO
● K2M5ESPT
2000 x 730 mm
Módulo: SST1384
Driver: DST1390-60W

1 x 1000mm	CURTO		K11MBDO	● DO 	TST1393DO 	DST1390-60W 	BST1391DO
			K11MBPT	● PT 	TST1393PT 	DST1390-60W 	BST1391PT
	LONGO		K11MADO	● DO 	TST1393DO 	DST1390-60W 	BST1392DO
			K11MAPT	● PT 	TST1393PT 	DST1390-60W 	BST1392PT
1 x 1500mm	CURTO		K115BDO	● DO 	TST1477DO 	DST1390-60W 	BST1391DO
			K115BPT	● PT 	TST1477PT 	DST1390-60W 	BST1391PT
	LONGO		K115MADO	● DO 	TST1477DO 	DST1390-60W 	BST1392DO
			K115MAPT	● PT 	TST1477PT 	DST1390-60W 	BST1392PT
1 x 2000mm	CURTO		K12BDO	● DO 	TST1480DO 	DST1390-60W 	BST1391DO
			K12BPT	● PT 	TST1480PT 	DST1390-60W 	BST1391PT
	LONGO		K12MADO	● DO 	TST1480DO 	DST1390-60W 	BST1392DO
			K12MAPT	● PT 	TST1480PT 	DST1390-60W 	BST1392PT

TST1398DO



TST1398PT



TST1399DO



TST1399PT



TST1398DO



TST1398PT



TST1399DO



TST1399PT



TST1398DO



TST1398PT







































TST1399DO































































TST1399PT





















































































2 x 1000mm	CURTO		K21MBDO	● DO	TST1393DO	TST1395DO	DST1390-60W
			K21MBPT	● PT	TST1393PT	TST1395PT	DST1390-60W
	LONGO		K21MADO	● DO	TST1393DO	TST1395DO	DST1390-60W
			K21MAPT	● PT	TST1393PT	TST1395PT	DST1390-60W
2 x 1500mm	CURTO		K215BDO	● DO	TST1477DO	TST1479DO	DST1390-60W
			K215BPT	● PT	TST1477PT	TST1479PT	DST1390-60W
	LONGO		K215ADO	● DO	TST1477DO	TST1479DO	DST1390-60W
			K215APT	● PT	TST1477PT	TST1479PT	DST1390-60W
2 x 2000mm	CURTO		K22BDO	● DO	TST1480DO	TST1482DO	DST1390-60W
			K22BPT	● PT	TST1480PT	TST1482PT	DST1390-60W
	LONGO		K22ADO	● DO	TST1480DO	TST1482DO	DST1390-60W
			K22APT	● PT	TST1480PT	TST1482PT	DST1390-60W

BST1391DO 	TST1396DO 	TST1398PDO 				
BST1391PT 	TST1396PT 	TST1398PPT 				
BST1392DO 	TST1397DO 	TST1399PDO 				
BST1392PT 	TST1397PT 	TST1399PPT 				
BST1391DO 	TST1396DO 	TST1398PDO 				
BST1391PT 	TST1396PT 	TST1398PPT 				
BST1392DO 	TST1397DO 	TST1399PDO 				
BST1392PT 	TST1397PT 	TST1399PPT 				
BST1391DO 	TST1396DO 	TST1398PDO 				
BST1391PT 	TST1396PT 	TST1398PPT 				
BST1392DO 	TST1397DO 	TST1399PDO 				
BST1392PT 	TST1397PT 	TST1399PPT 				

3 x 1000mm	CURTO		K31MBDO	● DO	TST1393DO	TST1394DO	TST1393DO
			K31MBPT	● PT	TST1393PT	TST1394PT	TST1393PT
	LONGO		K31MADO	● DO	TST1393DO	TST1394DO	TST1393DO
			K31MAPT	● PT	TST1393PT	TST1394PT	TST1393PT
3 x 1500mm	CURTO		K315MBDO	● DO	TST1477DO	TST1478DO	TST1477DO
			K315MBPT	● PT	TST1477PT	TST1478PT	TST1477PT
	LONGO		K315MADO	● DO	TST1477DO	TST1478DO	TST1477DO
			K315MAPT	● PT	TST1477PT	TST1478PT	TST1477PT
3 x 2000mm	CURTO		K32MBDO	● DO	TST1480DO	TST1481DO	TST1480DO
			K32MBPT	● PT	TST1480PT	TST1481PT	TST1480PT
	LONGO		K32MADO	● DO	TST1480DO	TST1481DO	TST1480DO
			K32MAPT	● PT	TST1480PT	TST1481PT	TST1480PT

DST1390-60W 	BST1391DO 	TST1396DO 	TST1396DO 	TST1398DO 		
DST1390-60W 	BST1391PT 	TST1396PT 	TST1396PT 	TST1398PT 		
DST1390-60W 	BST1392DO 	TST1397DO 	TST1397DO 	TST1399DO 		
DST1390-60W 	BST1392PT 	TST1397PT 	TST1397PT 	TST1399PT 		
DST1390-60W 	BST1391DO 	TST1396DO 	TST1396DO 	TST1398DO 		
DST1390-60W 	BST1391PT 	TST1396PT 	TST1396PT 	TST1398PT 		
DST1390-60W 	BST1392DO 	TST1397DO 	TST1397DO 	TST1399DO 		
DST1390-60W 	BST1392PT 	TST1397PT 	TST1397PT 	TST1399PT 		
DST1390-60W 	BST1391DO 	TST1396DO 	TST1396DO 	TST1398DO 		
DST1390-60W 	BST1391PT 	TST1396PT 	TST1396PT 	TST1398PT 		
DST1390-60W 	BST1392DO 	TST1397DO 	TST1397DO 	TST1399DO 		
DST1390-60W 	BST1392PT 	TST1397PT 	TST1397PT 	TST1399PT 		

4 x 1000mm	CURTO		K41MBDO	● DO	TST1393DO	TST1394DO	TST1393DO	
			K41MBPT	● PT	TST1393PT	TST1394PT	TST1393PT	
	LONGO		K41MADO	● DO	TST1393DO	TST1394DO	TST1393DO	
			K41MAPT	● PT	TST1393PT	TST1394PT	TST1393PT	
	4 x 1500mm	CURTO		K415MBDO	● DO	TST1477DO	TST1478DO	TST1477DO
				K415MBPT	● PT	TST1477PT	TST1478PT	TST1477PT
LONGO			K415MADO	● DO	TST1477DO	TST1478DO	TST1477DO	
			K415MAPT	● PT	TST1477PT	TST1478PT	TST1477PT	
4 x 2000mm		CURTO		K42MBDO	● DO	TST1480DO	TST1481DO	TST1480DO
				K42MBPT	● PT	TST1480PT	TST1481PT	TST1480PT
	LONGO		K42MADO	● DO	TST1480DO	TST1481DO	TST1480DO	
			K42MAPT	● PT	TST1480PT	TST1481PT	TST1480PT	

TST1395DO 	DST1390-60W 	BST1391DO 	TST1396DO 	TST1396DO 	TST1396DO 	TST1398PDO 
TST1395PT 	DST1390-60W 	BST1391PT 	TST1396PT 	TST1396PT 	TST1396PT 	TST1398PPT 
TST1395DO 	DST1390-60W 	BST1392DO 	TST1397DO 	TST1397DO 	TST1397DO 	TST1399PDO 
TST1395PT 	DST1390-60W 	BST1392PT 	TST1397PT 	TST1397PT 	TST1397PT 	TST1399PPT 
TST1479DO 	DST1390-60W 	BST1391DO 	TST1396DO 	TST1396DO 	TST1396DO 	TST1398PDO 
TST1479PT 	DST1390-60W 	BST1391PT 	TST1396PT 	TST1396PT 	TST1396PT 	TST1398PPT 
TST1479DO 	DST1390-60W 	BST1392DO 	TST1397DO 	TST1397DO 	TST1397DO 	TST1399PDO 
TST1479PT 	DST1390-60W 	BST1392PT 	TST1397PT 	TST1397PT 	TST1397PT 	TST1399PPT 
TST1482DO 	DST1390-60W 	BST1391DO 	TST1396DO 	TST1396DO 	TST1396DO 	TST1398PDO 
TST1482PT 	DST1390-60W 	BST1391PT 	TST1396PT 	TST1396PT 	TST1396PT 	TST1398PPT 
TST1482DO 	DST1390-60W 	BST1392DO 	TST1397DO 	TST1397DO 	TST1397DO 	TST1399PDO 
TST1482PT 	DST1390-60W 	BST1392PT 	TST1397PT 	TST1397PT 	TST1397PT 	TST1399PPT 







www.studiolute.com.br